



# XPowEr Inverter 300

## Owner's Guide

## **About Xantrex**

Xantrex Technology Inc. is a world-leading supplier of advanced power electronics and controls with products from 50 watt mobile units to one MW utility-scale systems for wind, solar, batteries, fuel cells, microturbines, and backup power applications in both grid-connected and stand-alone systems. Xantrex products include inverters, battery chargers, programmable power supplies, and variable speed drives that convert, supply, control, clean, and distribute electrical power.

## **Trademarks**

XPower is a trademark of Xantrex International. Xantrex is a registered trademark of Xantrex International.

Other trademarks, registered trademarks, and product names are the property of their respective owners and are used herein for identification purposes only.

## **Notice of Copyright**

XPower Inverter 300 Owner's Guide © February 2006 Xantrex International. All rights reserved.

## **Disclaimer**

UNLESS SPECIFICALLY AGREED TO IN WRITING, XANTREX TECHNOLOGY INC. ("XANTREX")

(a) MAKES NO WARRANTY AS TO THE ACCURACY, SUFFICIENCY OR SUITABILITY OF ANY TECHNICAL OR OTHER INFORMATION PROVIDED IN ITS MANUALS OR OTHER DOCUMENTATION.

(b) ASSUMES NO RESPONSIBILITY OR LIABILITY FOR LOSS OR DAMAGE, WHETHER DIRECT, INDIRECT, CONSEQUENTIAL OR INCIDENTAL, WHICH MIGHT ARISE OUT OF THE USE OF SUCH INFORMATION. THE USE OF ANY SUCH INFORMATION WILL BE ENTIRELY AT THE USER'S RISK.

# Table of Contents

<b>1. Introduction</b> .....	<b>1</b>
<b>2. Important Safety Information</b> .....	<b>2</b>
Warnings and Cautions .....	2
<b>3. XPower 300 Inverter Features</b> .....	<b>6</b>
AC Outlets .....	8
<b>4. Connecting the XPower 300</b> .....	<b>9</b>
Choosing a Location .....	9
Fastening the Inverter to a Mounting Surface .....	9
Connecting the XPower 300 to DC Power .....	10
Using the Cigarette Plug Wire Assembly .....	11
Using the Battery Clip Wire Assembly .....	12
Hardwiring the Inverter to the Battery .....	14
Disconnecting the Battery .....	18
Replacing the In-Line Fuse .....	18
<b>5. Operating the XPower 300</b> .....	<b>19</b>
Operating Statuses .....	19
Interference With Electronic Equipment .....	21
<b>6. Battery Operating Time</b> .....	<b>22</b>
<b>7. Troubleshooting</b> .....	<b>23</b>
<b>8. Specifications</b> .....	<b>27</b>
Electrical .....	27
Physical .....	28
Regulatory .....	28
Product Recycling .....	29
<b>9. Limited Warranty</b> .....	<b>30</b>
<b>10. Other Xantrex Products</b> .....	<b>36</b>



# 1 Introduction

Thank you for purchasing the XPower Inverter 300. The XPower 300 is part of a family of advanced, high-performance power inverters from Xantrex, the leader in the field of high-frequency inverter design.

Connected to the 12 volt outlet in your vehicle or directly to your battery for loads over 150 watts, the XPower 300 efficiently and reliably powers a wide variety of household AC products, such as TVs and VCRs, laptop computers, camcorder and cell phone chargers, compact fluorescent lights, and soldering irons.

The XPower 300 uses reliable solid state power electronics for years of safe, trouble-free operation and includes automatic safety monitoring circuitry to protect it from inadvertent overload conditions.

Read this guide before connecting or using the XPower 300, and save it for future reference. The main topics in the guide are:

- Safety information (page 2)
- XPower 300 features (page 6)
- Instructions for connecting the inverter (page 9)
- Operating guidelines (page 19)
- Troubleshooting information (page 23)
- Specifications (page 27)
- Warranty and service information (page 30)

## 2 Important Safety Information

If the XPower 300 is connected or used incorrectly, hazardous conditions may be created. Read and save this safety information, and pay special attention to all Caution and Warning statements in the guide and on the inverter itself. Warnings and Cautions are indicated by this symbol:



- **Warning** statements identify conditions that could result in personal injury or loss of life.
- **Caution** statements identify conditions or practices that could result in damage to the XPower 300 or other equipment.

### Warnings and Cautions

6



#### **WARNING: Shock hazard**

The XPower 300 generates the same potentially lethal AC power as a household wall outlet. Do not insert foreign objects in the inverter's AC outlet or any other openings in the inverter. Do not open the inverter. Have a qualified individual complete any service work.



#### **WARNING: Shock hazard**

Do not expose the XPower 300 to water, rain, snow, or spray.

---



### **WARNING: Risk of fire or explosion**

The XPower 300 contains components that tend to produce arcs or sparks. To prevent fire or explosion, do not install the inverter in compartments containing batteries or flammable materials or in locations that require ignition-protected equipment.



### **WARNING: Fire hazard**

To reduce the risk of fire, do not cover or obstruct the ventilation openings. Do not install the XPower 300 in a zero-clearance compartment. Overheating may result.



### **WARNING: Shock and fire hazard**

During installation route all cable/wiring away from sharp edges and hot surfaces of the engine compartment or vehicle.

---



### **CAUTION: Risk of damage to equipment**

The XPower 300 is designed to be directly connected to standard electrical and electronic equipment in the manner described in this guide. Do not connect it to household or RV AC distribution wiring. Do not connect it to any AC load circuit in which the neutral conductor is connected to ground (earth) or to the negative of the DC (battery) source.



### **CAUTION: Risk of damage to the XPower 300**

Reverse battery polarity (negative connected to positive; positive connected to negative) will damage the XPower 300, and it will require servicing. Damage caused by reverse polarity is not covered by your warranty.

---





## **CAUTION: Risk of damage to rechargeable appliances**

The output of the XPower 300 is non-sinusoidal. Certain battery chargers can be damaged if they are connected to the XPower 300. Two particular types of equipment are prone to this problem:

- Small battery-operated appliances such as rechargeable flashlights, shavers, and night lights that can be plugged directly into an AC receptacle to recharge.
- Certain battery chargers for battery packs used in hand power tools. These chargers have a warning label stating that dangerous voltages are present at the charger battery terminals.

Do not use the XPower 300 with the type of appliances just described.



## **CAUTION: Risk of damage due to high temperatures**

Do not use the XPower 300 in temperatures over 40° C (105° F). Overheating may result.

---

## 3 XPower 300 Inverter Features

This section describes the main features of the XPower 300. Figure 1 shows the inverter's AC panel.

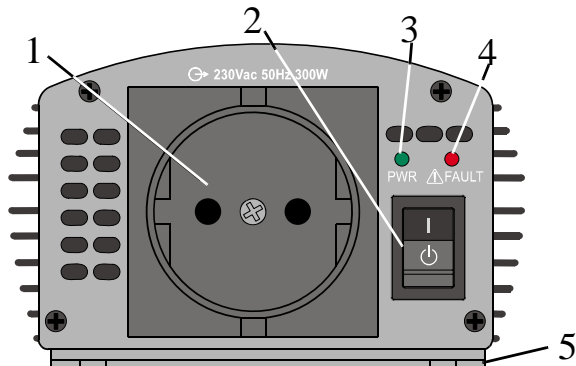

Figure 1 AC Panel on the XPower 300 (European AC Outlet)

**1 AC Outlet** An AC outlet is located on one end of the inverter. It allows you to plug in a 230 volt AC product with a power consumption of 150 watts or less when the inverter is operated from a vehicle lighter socket, or 300 watts or less when it is connected directly to a battery.

The AC outlet on your inverter may be different from the one shown here. For all available outlets, see Figure 2, Figure 3, and Figure 4, on page 8.

**2 On/Standby Switch** The two positions on the On/Standby switch are:  $\text{⏻}$  = Standby and  $\text{⏻}$  = On.

When the inverter is connected to a DC power source and the On/Standby switch is on, AC power is available at the outlet.

**3 Power Light** The green PWR light is on all the time when the On/Standby switch is on.

**4 Fault Light** The red  FAULT light indicates that the inverter has shut down because of low or high battery voltage, AC overload, or excessively high temperatures.

**5 Mounting Flanges** Mounting flanges on the AC and DC ends allow you to mount the inverter permanently. For additional information, see “Fastening the Inverter to a Mounting Surface” on page 9.

**Audible Alarm** An audible alarm warns you of a high temperature shutdown or of an impending low voltage shutdown.

**Fan** The fan (see Figure 5) turns on when an AC load of 100 watts or larger is plugged in.

# AC Outlets

Depending on your geographic location, your XPower 300 will have one of the following AC outlets.

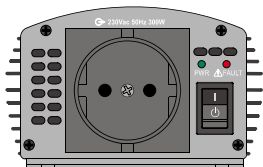

Figure 2 European AC Outlet

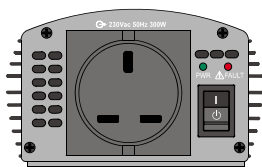

Figure 3 British AC Outlet

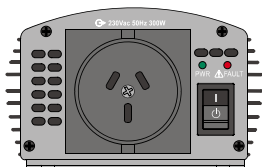

Figure 4 Australian and New Zealand AC Outlet

## 4 Connecting the XPower 300

This section explains how to connect the XPower 300.

### Choosing a Location

For the best performance, choose a location that is:

- **Dry** Do not expose the inverter to water drip or spray.
- **Cool** Operate the inverter in ambient temperatures between 0° C and 40° C (32° F and 100° F). Keep it away from heating vents and direct sunlight.
- **Well ventilated** For proper cooling, allow at least 5 cm (2 in.) of clearance around the inverter.
- **Clean and free of dust and dirt** Choose a location that is free of any debris that could get into the inverter.
- **Protected from battery gases** Do not mount the inverter where it will be exposed to battery gases. These are very corrosive and will damage the inverter.

### Fastening the Inverter to a Mounting Surface

For temporary or portable use, place the inverter on a flat surface like a table or the floor of your vehicle.

For a permanent installation, use four screws to attach the inverter's mounting flanges to an appropriate surface.

Note: Local and national electrical codes that apply to your installation may require that you permanently mount the inverter if you make permanent electrical connections and may disallow permanent mounting if you make a temporary electrical connection.

# Connecting the XPower 300 to DC Power



## CAUTION: Risk of damage to the XPower 300

The XPower 300 must only be operated with a nominal 12 volt battery. The inverter will not operate with a lower voltage battery. A higher voltage battery will damage the inverter.

You can connect the inverter to a 12 volt DC power source using:

- The cigarette plug wire assembly (page 11)
- The battery clip wire assembly (page 12)
- A hardwired connection to the battery (page 14)

Your method will depend on the size of the AC loads you want to power. When you connect the inverter, refer to Figure 5 and Figure 6.



Figure 5 DC Panel on the XPower 300

1 Fan 2 Red (positive +) terminal 3 Black (negative -) terminal

## Using the Cigarette Plug Wire Assembly

---



### **WARNING: Fire hazard**

The wires in most 12 volt sockets or power outlets are not large enough for loads greater than 150 watts: they will overheat and present a fire hazard.

Do not use loads greater than 150 watts with the cigarette plug wire assembly.

---

**Loads under 150 watts** When you are going to power loads under 150 watts, use the cigarette plug wire assembly.

To connect the inverter:

1. Remove the nuts from the DC terminals on the inverter.
  2. Place the red ring connector on the inverter's red (positive +) DC terminal, and then screw the red nut on until it is snug. Do not over tighten.
  3. Place the black ring connector on the inverter's black (negative -) DC terminal, and then screw the black nut on until it is snug. Do not over tighten.
- 



### **CAUTION: Damage to the XPower 300**

Reversing the positive and negative battery cables will damage the inverter and will void your warranty.

Double check the wiring connections: the red connector must be connected to the red terminal, and the black connector must be connected to the black terminal.

---

4. Place the lighter plug in the vehicle's cigarette lighter socket or a 12 volt outlet.

5. Turn on the inverter's On/Standby switch. The PWR light comes on, and AC power is available at the outlet.  
**Note:** You may need to turn the vehicle's ignition key to the accessory position.
6. Plug in the AC load you want to operate.

## Using the Battery Clip Wire Assembly

**Loads greater than 150 watts** When you are going to power loads that are greater than 150 watts (up to 300 watts continuous power), connect the inverter to a 12 volt battery using the battery clip wire assembly.



### **WARNING: Corrosive materials and energy hazard**

To reduce the risk of irritation and burns, wear protective eyewear and clothing when you work with batteries. Take special care to ensure that metal tools or personal objects like rings or watches do not contact the battery terminals.



### **WARNING: Fire hazard**

The wires in most 12 volt sockets or power outlets are not large enough for loads greater than 150 watts: they will overheat and present a fire hazard. For loads greater than 150 watts, connect the inverter directly to the battery and use appropriately sized wires like those in the battery clip wire assembly provided with the inverter.

---





## CAUTION: Risk of damage to the XPower 300

Reversing the positive and negative battery cables will damage the inverter and void your warranty.

When you connect the inverter to the battery, double check the connections. The red wire must be connected to the red (+) terminal on the inverter and the positive (+) terminal on the battery. The black wire must be connected to the black (-) terminal on the inverter and the negative (-) terminal on the battery.

---

To connect the inverter:

1. Remove the nuts from the DC terminals on the inverter.
2. Place the red ring connector on the red (positive +) DC terminal, and then screw the red nut on until it is snug. Do not over tighten.
3. Attach the red clip to the red (positive +) battery terminal.
4. Attach the black clip to the black (negative -) battery terminal.
5. Place the black ring connector on the black (negative -) DC terminal, and then screw the black nut on until it is snug. Do not over tighten.

**Note:** A spark may occur when you make this connection. This is normal.

6. Check that both clips are securely connected to the battery terminals. A loose connection will cause excessive voltage drop and may cause the cables to overheat. This could result in equipment damage or fire.

7. Turn on the On/Standby switch. The green PWR light comes on, and AC power is available at the outlet.

## Hardwiring the Inverter to the Battery

### Loads of any size (up to 300 watts continuous power)

For a permanent electrical connection, or when you need to power some loads that are greater than 150 watts and some that are less than 150 watts, you can hardwire the inverter to the battery. This eliminates the need to switch between the battery clip wire assembly and the cigarette plug wire assembly. A hardwired installation is illustrated in Figure 6.



### WARNING: Shock and fire hazard

Use a qualified installer to perform a hardwired connection.

---

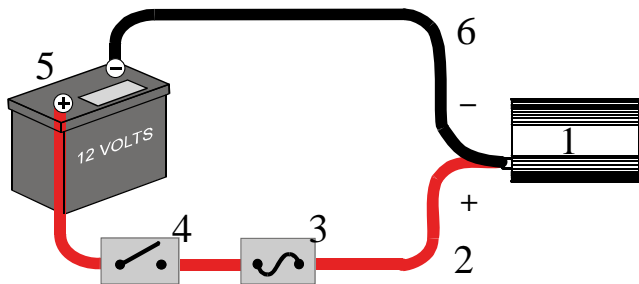

Figure 6 Hardwiring the XPower 300 to a 12 Volt Battery

1 XPower 300 2 3.3mm<sup>2</sup> (12 AWG) red wire from the positive inverter terminal to the positive battery terminal (via the fuse and the switch) 3 40 amp automotive fuse 4 12 volt, 40 amp disconnect switch 5 12 volt battery 6 3.3mm<sup>2</sup> (12 AWG) black wire from the negative inverter terminal to the negative battery terminal

---



### **WARNING: Fire hazard**

The wires in most 12 volt sockets or power outlets are not large enough for loads greater than 150 watts: they will overheat and present a fire hazard.

For loads greater than 150 watts, connect the inverter directly to the battery and use appropriately sized wires like those in the battery clip wire assembly provided with the inverter.

---

To hardwire the inverter to the battery:

1. Cut the clips off the cable clip wire assembly. (The wires in this assembly are appropriate for loads over 150 watts. The wires in the cigarette plug wire assembly are too small: do not use them.)
2. Using  $3.3\text{mm}^2$  (12 AWG) wire or heavier, extend the power cord if you need to, to a maximum total length of 2 meters (6.5 feet) including the existing XPower 300 power cord length. Solder all connections and make sure they are properly insulated by using electrical tape or heat shrinkable tubing.
3. Install a 40 amp automotive fuse and a switch rated at 40 amps in the positive (red) wire, close to the end that will attach to the battery. See Figure 6. The switch lets you disconnect the DC power if you need to replace the in-line fuse. Solder and insulate the connections as detailed in Step 2 above.
4. Turn off the in-line switch.
5. Solder or crimp heavy-duty terminals to the battery end of the positive and negative wires. Use terminals that mate properly with the battery terminals or battery cable clamps.



## **CAUTION: Risk of damage to the XPower 300**

Reversing the positive and negative battery cables will damage the inverter and will void your warranty.

Before connecting the inverter to the battery, double check the connections: the red wire must be connected to the red terminal on the inverter and the positive (+) terminal on the battery; the black wire must be connected to the black terminal on the inverter and the negative (-) terminal on the battery.

---

6. Remove the nuts from the DC terminals of the inverter.
7. Place the red ring connector on the red (positive +) DC terminal on the inverter, and then screw the red nut on until it is snug. Do not over tighten.
8. Fasten the positive terminal (red wire) to the positive battery post.
9. Fasten the negative terminal (black wire) to the negative battery post.
10. Place the black ring connector on the black (negative -) DC terminal on the inverter, and then screw the black nut on until it is snug. Do not over tighten.
11. Turn on the in-line switch.
12. Turn on the inverter's On/Standby switch. The PWR light comes on, and AC power is available at the outlet.

## Disconnecting the Battery

- Before you disconnect the battery, turn off the AC load, and then turn off the in-line switch.

## Replacing the In-Line Fuse

- If you need to replace the in-line fuse (see Figure 6), turn off the in-line switch to disconnect the DC power.

## 5 Operating the XPower 300

This section describes normal operation as well as several problems that could occur when you use the inverter. If you have a problem, see “Troubleshooting” on page 23.

### Operating Statuses

- **Normal Operation** When you connect the inverter to your vehicle’s 12 volt source and turn on the On/Standby switch, the green PWR light comes on, and AC power is available at the outlet.  
The inverter shuts down automatically in response to low battery voltage, high battery voltage, AC overload, overheating, or a short in the AC output.
- **Low Battery Voltage Alarm and Shutdown** As the battery discharges, its voltage decreases.  
When the inverter senses that the voltage at its DC input has dropped to 10.7 volts, it sounds an alarm. This gives you time to shut down computers or other sensitive devices. If you ignore the alarm, and the DC input drops to 10.0 volts, the inverter shuts down the AC load being operated. The PWR light stays on, the alarm stays on, and the  FAULT light comes on as well. The low battery voltage shutdown feature is designed to save the battery from excessive discharge, which can prevent you from starting your vehicle, or more seriously, damage the battery.
- **Possible shutdown when the vehicle’s engine is started** The XPower 300 will operate while your vehicle’s engine is running, but the normal voltage drop

that occurs when the engine starts may trigger a low voltage shutdown.

- **AC Overload Shutdown** If you connect an AC load rated higher than 300 watts or 1.3 amps or that draws excessive surge power, the XPower 300 shuts down. The PWR light stays on, and the  $\wedge$ FAULT light comes on to indicate that the inverter is overloaded.

**Note: High startup surge requirements** The power, or “wattage” rating of an AC load is the average amount of power it uses. When they are first turned on, many AC loads consume more power than their continuous power rating. TVs, monitors, and electric motors are examples of loads that have high surge requirements at start up. Although the XPower 300 can supply momentary surge power to 600 watts, some products rated less than 300 watts can exceed its surge capabilities and trigger the AC overload shutdown feature. (See page 23 for troubleshooting procedures.)

- **High Battery Voltage Shutdown** If a defective battery charging system causes the battery voltage to rise to dangerously high levels, the inverter shuts down automatically. The PWR light stays on, and the  $\wedge$ FAULT light comes on.
- **High Temperature Shutdown** If the inverter exceeds its safe operating temperature because of insufficient ventilation or a high-temperature environment, it sounds an alarm and shuts down automatically. The PWR light stays on, and the  $\wedge$ FAULT light comes on. When the inverter has cooled sufficiently, it restarts automatically.



## Interference With Electronic Equipment

Most AC products operate with the XPower 300 as they would with household AC power with the following exceptions.

**Buzzing Sound** Some inexpensive stereo systems and “boom boxes” have inadequate internal power supply filtering and buzz slightly when powered by the XPower 300. The best solution is to have an audio system with a good quality filter.

**Television Interference** The XPower 300 is shielded to minimize its interference with TV signals. If TV signals are weak, you may see the interference in the form of lines scrolling across the screen. Try one of these suggestions to minimize or eliminate the problem:

- Adjust the orientation of the inverter, TV, antenna, and cables.
- Maximize TV signal strength by using a better antenna, and use shielded antenna cable where possible.
- Try a different TV. Different models vary considerably in their susceptibility to interference.

## 6 Battery Operating Time

The battery operating time of the XPower 300 depends on the charge level of the battery, battery capacity, and the amount of power drawn by the particular AC load. With a typical vehicle battery and a 300 watt load, you can expect one or more hours of operating time.

To preserve the battery:

- Do not allow your vehicle battery to become deeply discharged. A vehicle battery (starting battery) is not designed to be deeply discharged, and repeated deep discharge/charge cycles will shorten its life.

When you use a vehicle battery as a power source, start the vehicle every hour or two and run it until you have partially recharged the battery.

- Do not leave the XPower 300 on for more than a week if you do not have an AC load connected to it.

The inverter draws less than 0.2 amps with the On/Standby switch on and no load connected, but that will eventually discharge the battery.

- When the XPower 300 is not in use, do one of the following:
  - Unplug it from the 12 volt outlet.
  - Disconnect the DC cable clips from the battery.
  - Turn off the in-line switch if the inverter is hardwired to the battery.

# 7 Troubleshooting

---



## **WARNING: Shock hazard**

Do not open the inverter or attempt to service it yourself. Refer all service to qualified personnel.

---

This section describes problems you may encounter, the symptoms of each problem, possible causes, and various remedies.

**The AC load will not operate; the red  FAULT light is on.**

**Symptom** An AC load is plugged in or turned on, operates for one to ten seconds, and then shuts down.

Possible cause	Suggested remedy
The AC load is rated at more than 300 watts; an overload shutdown has occurred.	Use an AC load with a power rating less than 300 watts (1.3 amps).
The AC load is rated at less than 300 watts, but a high starting surge has caused an overload shutdown.	The AC load exceeds the inverter's surge capability. Use a load with a starting surge power within its capability.

**Symptom** The AC load does not operate. The  FAULT light comes on when the inverter is turned on or when the AC load is turned on or plugged in. The alarm may sound.

<b>Possible cause</b>	<b>Suggested remedy</b>
The battery is discharged.	Recharge the battery.
The battery voltage is excessive.	Check the charging system.
The AC load exceeds the 150 watt rating for the lighter socket.	Connect the inverter directly to the battery. See “Using the Battery Clip Wire Assembly” on page 12 or “Hardwiring the Inverter to the Battery” on page 14.

**Symptom** The AC load runs for more than one minute, the alarm sounds, and the  FAULT light comes on. The inverter is warm or hot to touch. The alarm may sound.

<b>Possible cause</b>	<b>Suggested remedy</b>
Poor ventilation or a high-temperature environment has caused the inverter to overheat.	Ensure that ventilation is not restricted around the inverter. The inverter will turn on again automatically when it has cooled sufficiently.

**The AC load will not operate; no inverter lights are on.**

**Symptom** The cigarette lighter works in the lighter socket, but the inverter does not.

<b>Possible cause</b>	<b>Suggested remedy</b>
The contact between the plug and the lighter socket or the 12 volt outlet is poor.	Press the plug firmly into the socket. Clean the plug or socket if necessary.
The inverter has been connected with reverse DC input polarity.	The inverter has probably been damaged. Have it repaired. Damage caused by reverse polarity is not covered by the warranty. Instructions for returning the inverter are on page 35.

**Symptom** The cigarette lighter does not work in the lighter socket.

<b>Possible cause</b>	<b>Suggested remedy</b>
The lighter socket or the 12 volt outlet may require that the ignition be switched on.	Turn the key to the accessory position.
The cigarette lighter fuse or the 12 volt outlet fuse is blown.	Check the vehicle fuses, and replace the blown fuse with the correct type and size.

## Measured inverter output voltage is too low.

**Symptom** The AC voltmeter reading is 5 to 15 volts too low.

Possible cause	Suggested remedy
A standard “average-reading” AC voltmeter has been used to measure output voltage.	For accuracy, the XPower 300 modified sine wave output needs to be measured with a “true RMS” voltmeter, like a Fluke 87 series multimeter.
The battery voltage is too low.	Recharge the battery.

## Battery operating time is less than expected.

**Symptom** The inverter runs for a while, and then the **▲FAULT** light comes on. The inverter is cool or warm to touch.

Possible cause	Suggested remedy
The battery is old or defective.	Replace the battery.
The battery is not being charged properly.	Have a qualified technician check the vehicle’s electrical system.

# 8 Specifications

Specifications may change without notice.

## Electrical

AC receptacles	1
AC output voltage	230 volts AC RMS $\pm$ 5%
AC output frequency	50 $\pm$ 3 Hz
AC output waveform	Modified Sine Wave
Maximum continuous AC output power	300 watts
Maximum AC output surge power	600 watts
DC input voltage range	10–15 volts DC
Battery drain with no AC load (at 12V input) and inverter switch on	0.20 amps
Efficiency (optimal)	90%
Ambient operating temperature range	0° C–40° C (32° F–105° F)
Low battery voltage alarm	10.7 volts DC
Low battery voltage shutdown	10.0 volts DC
High battery voltage shutdown	15.0 volts DC
Over-temperature shutdown	Automatic shutdown and automatic restart
Overload shutdown	Automatic shutdown and automatic restart
Internal fuse	40 amps

# Physical

Dimensions (L x W x H)	200mm x 103mm x 66mm (7.9 in. x 4.1 in. x 2.6 in.)
Weight	0.79 Kg (1.74 lb.)

# Regulatory

CE Mark	Low Voltage Directive
e Mark	Automotive EMC Directive
TUV/Type approved	Certified to EN60950
Environmental	Complies with the EU's "Restriction of Hazardous Substances" Directive 2002/95/EC



# Product Recycling

---



Do not dispose of this product with general household waste!



Electrical appliances marked with the symbol shown must be professionally treated to recover, reuse, and recycle materials, in order to reduce negative environmental impact. When the product is no longer usable, the consumer is legally obligated to ensure that it is collected separately under the local electronics recycling and treatment scheme. See [www.xantrex.com](http://www.xantrex.com).

---

# 9 Limited Warranty

## Warranty

**What does this warranty cover?** This Limited Warranty is provided by Xantrex Technology, Inc. ("Xantrex") and covers defects in workmanship and materials in your XPower Inverter 300. This warranty period lasts for twenty-four (24) months from the date of purchase at the point of sale to you, the original end user customer. You require proof of purchase to make warranty claims.

This Limited Warranty is transferable to subsequent owners but only for the unexpired portion of the Warranty Period. Subsequent owners also require proof of purchase.

**What will Xantrex do?** Xantrex will, at its option, repair or replace the defective product free of charge, provided that you notify Xantrex of the product defect within the Warranty Period, and provided that Xantrex through inspection establishes the existence of such a defect and that it is covered by this Limited Warranty.

Xantrex will, at its option, use new and/or reconditioned parts in performing warranty repair and building replacement products. Xantrex reserves the right to use parts or products of original or improved design in the repair or replacement. If Xantrex repairs or replaces a product, its warranty continues for the remaining portion of the original Warranty Period or 90 days from the date of the return shipment to the customer, whichever is greater. All replaced products and all parts removed from repaired products become the property of Xantrex.

Xantrex covers both parts and labor necessary to repair the product, and return shipment to the customer via a Xantrex-selected non-expedited surface freight within the contiguous United States and Canada. Alaska and Hawaii are excluded. Contact Xantrex Customer Service for details on freight policy for return shipments outside of the contiguous United States and Canada.

**How do you get service?** If your product requires troubleshooting or warranty service, contact your merchant. If you are unable to contact your merchant, or the merchant is unable to provide service, contact Xantrex directly at:

Telephone: 1 360 925 5097 (direct)

Fax: 1 360 925 5143 (direct)

Email: customerservice@xantrex.com

Direct returns may be performed according to the Xantrex Return Material Authorization Policy described in your product manual. For some products, Xantrex maintains a network of regional Authorized Service Centers. Call Xantrex or check our website to see if your product can be repaired at one of these facilities.

**What proof of purchase is required?** In any warranty claim, dated proof of purchase must accompany the product and the product must not have been disassembled or modified without prior written authorization by Xantrex.

Proof of purchase may be in any one of the following forms:

- The dated purchase receipt from the original purchase of the product at point of sale to the end user, or
- The dated dealer invoice or purchase receipt showing original equipment manufacturer (OEM) status, or
- The dated invoice or purchase receipt showing the product exchanged under warranty

**What does this warranty not cover?** This Limited Warranty does not cover normal wear and tear of the product or costs related to the removal, installation, or troubleshooting of the customer's electrical systems. This warranty does not apply to and Xantrex will not be responsible for any defect in or damage to:

- a) the product if it has been misused, neglected, improperly installed, physically damaged or altered, either internally or externally, or damaged from improper use or use in an unsuitable environment;
- b) the product if it has been subjected to fire, water, generalized corrosion, biological infestations, or input voltage that creates operating conditions beyond the maximum or minimum limits listed in the Xantrex product specifications including high input voltage from generators and lightning strikes;
- c) the product if repairs have been done to it other than by Xantrex or its authorized service centers (hereafter "ASCs");
- d) the product if it is used as a component part of a product expressly warranted by another manufacturer;
- e) the product if its original identification (trade-mark, serial number) markings have been defaced, altered, or removed.

## Disclaimer

### Product

THIS LIMITED WARRANTY IS THE SOLE AND EXCLUSIVE WARRANTY PROVIDED BY XANTREX IN CONNECTION WITH YOUR XANTREX PRODUCT AND IS, WHERE PERMITTED BY LAW, IN LIEU OF ALL OTHER WARRANTIES, CONDITIONS, GUARANTEES, REPRESENTATIONS, OBLIGATIONS AND LIABILITIES, EXPRESS OR IMPLIED, STATUTORY OR OTHERWISE IN CONNECTION WITH THE PRODUCT, HOWEVER ARISING (WHETHER BY CONTRACT, TORT, NEGLIGENCE, PRINCIPLES OF MANUFACTURER'S LIABILITY, OPERATION OF LAW, CONDUCT, STATEMENT OR OTHERWISE), INCLUDING WITHOUT

RESTRICTION ANY IMPLIED WARRANTY OR CONDITION OF QUALITY, MERCHANTABILITY OR FITNESS FOR A PARTICULAR PURPOSE. ANY IMPLIED WARRANTY OF MERCHANTABILITY OR FITNESS FOR A PARTICULAR PURPOSE TO THE EXTENT REQUIRED UNDER APPLICABLE LAW TO APPLY TO THE PRODUCT SHALL BE LIMITED IN DURATION TO THE PERIOD STIPULATED UNDER THIS LIMITED WARRANTY.

IN NO EVENT WILL XANTREX BE LIABLE FOR ANY SPECIAL, DIRECT, INDIRECT, INCIDENTAL OR CONSEQUENTIAL DAMAGES, LOSSES, COSTS OR EXPENSES HOWEVER ARISING WHETHER IN CONTRACT OR TORT INCLUDING WITHOUT RESTRICTION ANY ECONOMIC LOSSES OF ANY KIND, ANY LOSS OR DAMAGE TO PROPERTY, ANY PERSONAL INJURY, ANY DAMAGE OR INJURY ARISING FROM OR AS A RESULT OF MISUSE OR ABUSE, OR THE INCORRECT INSTALLATION, INTEGRATION OR OPERATION OF THE PRODUCT.

## **Exclusions**

If this product is a consumer product, federal law does not allow an exclusion of implied warranties. To the extent you are entitled to implied warranties under federal law, to the extent permitted by applicable law they are limited to the duration of this Limited Warranty. Some states and provinces do not allow limitations or exclusions on implied warranties or on the duration of an implied warranty or on the limitation or exclusion of incidental or consequential damages, so the above limitation(s) or exclusion(s) may not apply to you. This Limited Warranty gives you specific legal rights. You may have other rights which may vary from state to state or province to province.

The rights granted by this warranty are in addition to any statutory or other legal rights granted under the laws of the country or state in which the Xantrex product was purchased and those legal rights are not affected by this warranty.

## Warning: Limitations On Use

Please refer to your product manual for limitations on uses of the product.

SPECIFICALLY, PLEASE NOTE THAT THE XPOWER INVERTER 300 SHOULD NOT BE USED IN CONNECTION WITH LIFE SUPPORT SYSTEMS OR OTHER MEDICAL EQUIPMENT OR DEVICES. WITHOUT LIMITING THE GENERALITY OF THE FOREGOING, XANTREX MAKES NO REPRESENTATIONS OR WARRANTIES REGARDING THE USE OF THE XANTREX XPOWER INVERTER 300 IN CONNECTION WITH LIFE SUPPORT SYSTEMS OR OTHER MEDICAL EQUIPMENT OR DEVICES.

Please note that the XPower Inverter 300 is not intended for use as an uninterruptible power supply and Xantrex makes no warranty or representation in connection with any use of the product for such purposes.

## Return Material Authorization Policy

Before returning a product directly to Xantrex you must obtain a Return Material Authorization (RMA) number and the correct factory "Ship To" address. Products must also be shipped prepaid. Product shipments will be refused and returned at your expense if they are unauthorized, returned without an RMA number clearly marked on the outside of the shipping box, if they are shipped collect, or if they are shipped to the wrong location.

When you contact Xantrex to obtain service, please have your instruction manual ready for reference and be prepared to supply:

- The serial number of your product
- Information about the installation and use of the unit
- Information about the failure and/or reason for the return
- A copy of your dated proof of purchase

# Return Procedure

1. Package the unit safely, preferably using the original box and packing materials. Please ensure that your product is shipped fully insured in the original packaging or equivalent. This warranty will not apply where the product is damaged due to improper packaging.
2. Include the following:
  - The RMA number supplied by Xantrex Technology, Inc. clearly marked on the outside of the box.
  - A return address where the unit can be shipped. Post office boxes are not acceptable.
  - A contact telephone number where you can be reached during work hours.
  - A brief description of the problem.
3. Ship the unit prepaid to the address provided by your Xantrex customer service representative.

**If you are returning a product from outside of the USA or Canada** In addition to the above, you **MUST** include return freight funds and are fully responsible for all documents, duties, tariffs, and deposits.

**If you are returning a product to a Xantrex Authorized Service Center (ASC)** A Xantrex return material authorization (RMA) number is not required. However, you must contact the ASC prior to returning the product or presenting the unit to verify any return procedures that may apply to that particular facility.

## Out of Warranty Service

If the warranty period for your XPower Inverter 300 has expired, if the unit was damaged by misuse or incorrect installation, if other conditions of the warranty have not been met, or if no dated proof of purchase is available, your inverter may be serviced or replaced for a flat fee.

To return your XPower Inverter 300 for out of warranty service, contact Xantrex Customer Service for a Return Material Authorization (RMA) number and follow the other steps outlined in “Return Procedure” on page 35.

Payment options such as credit card or money order will be explained by the Customer Service Representative. In cases where the minimum flat fee does not apply, as with incomplete units or units with excessive damage, an additional fee will be charged. If applicable, you will be contacted by Customer Service once your unit has been received.

## 10 Other Xantrex Products

To see the range of inverters and chargers offered by Xantrex, visit our web site at <http://www.xantrex.com>.