

Smart choice for power™

xantrex™
A MISSION CRITICAL ELECTRONICS BRAND

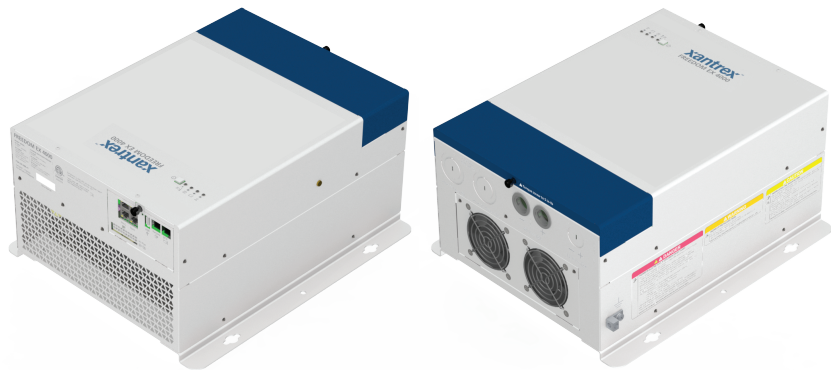

Owner's Guide

Freedom EX 4000 Inverter/Charger with 48VDC-to-12VDC Converter

Freedom EX 4000
PN: 820-4080-41

Copyright © 2019-2021 Xantrex LLC. All Rights Reserved.

All trademarks are owned by Xantrex LLC and its affiliates.

Exclusion for Documentation

UNLESS SPECIFICALLY AGREED TO IN WRITING, SELLER

(A) MAKES NO WARRANTY AS TO THE ACCURACY, SUFFICIENCY OR SUITABILITY OF ANY TECHNICAL OR OTHER INFORMATION PROVIDED IN ITS MANUALS OR OTHER DOCUMENTATION;

(B) ASSUMES NO RESPONSIBILITY OR LIABILITY FOR LOSSES, DAMAGES, COSTS OR EXPENSES, WHETHER SPECIAL, DIRECT, INDIRECT, CONSEQUENTIAL OR INCIDENTAL, WHICH MIGHT ARISE OUT OF THE USE OF SUCH INFORMATION. THE USE OF ANY SUCH INFORMATION WILL BE ENTIRELY AT THE USER'S RISK; AND

(C) REMINDS YOU THAT IF THIS MANUAL IS IN ANY LANGUAGE OTHER THAN ENGLISH, ALTHOUGH STEPS HAVE BEEN TAKEN TO MAINTAIN THE ACCURACY OF THE TRANSLATION, THE ACCURACY CANNOT BE GUARANTEED. APPROVED CONTENT IS CONTAINED WITH THE ENGLISH LANGUAGE VERSION WHICH IS POSTED AT <http://www.xantrex.com/>.

NOTE: Visit <http://www.xantrex.com/> , click Products, select a Product category, select a Product, and search the Product Documents panel for a translation of the English guide, if available.

Document Number: 975-0999-01-01

Rev C

Date: October 2021

Product Name and Part Number

Freedom EX 4000 (820-4080-41)

Contact Information

Telephone: (Toll Free USA/Canada) +1 800 670 0707 / (Outside USA/Canada) +1 408 987 6030

Email: customerservice@xantrex.com,
<http://www.xantrex.com/power-products-support/>

Web: <http://www.xantrex.com/>



Information About Your System

As soon as you open your product, record the following information and be sure to keep your proof of purchase.

Serial Number _____

Product Number _____

Purchased From _____

Purchase Date _____

To view, download, or print the latest revision, visit the website shown under **Contact Information**.

Purpose

The purpose of this Owner's Guide is to provide explanations and procedures for operating, configuring, maintaining, and troubleshooting a Freedom EX 4000 Inverter/Charger with 48VDC-to-12VDC Converter for Recreational, Commercial and Fleet Vehicle, or Marine installations.

Scope

The guide provides safety and operating guidelines as well as information on configuring the inverter/charger/converter. It also provides information about troubleshooting the unit. It does not provide details about particular brands of batteries. You need to consult individual battery manufacturers for this information.

Audience

The guide is intended for users and operators of the Freedom EX 4000. A separate *Freedom EX Installation Guide* (document number: 975-0998-01-01) is intended for qualified personnel.

Qualified personnel have training, knowledge, and experience in:

- Installing electrical equipment (up to 1000 V).
- Applying all applicable installation codes.
- Analyzing and reducing the hazards involved in performing electrical work.
- Installing and configuring lead-acid and/or lithium-ion batteries.
- Selecting and using PPE and following safety work code practices. See NFPA 70E or CSA Z462.

Abbreviations and Acronyms

A	Amperes
Ah	Amp-hours (a unit of battery capacity)
AC	Alternating Current [~]
AGM	Absorbed Glass Mat (a battery type)
BTS	Battery Temperature Sensor
DC	Direct Current [---]
GFCI	Ground Fault Circuit Interrupter
Hz	Hertz (a unit of frequency)
in-lb	inch-pound force (a unit of torque)
kW	Kilowatts (1000 watts)
LBCO	Low Battery Cutout (or Cutoff)
LCD	Liquid Crystal Display
LED	Light Emitting Diode
LFP	LiFePO ₄ (lithium iron phosphate – a battery type)
N-m	Newton-meters (a unit of torque)
PN	Product Number
PPE	Personal Protective Equipment
RV-C	Recreational Vehicle CAN Bus Communications protocol
s	Seconds (a unit of time)
V, VAC, VDC	Voltage, Volts AC, Volts DC
W	Wattage, watt (a unit of power)

Related Information

You can find more information about Xantrex products and services at <http://www.xantrex.com/>.

IMPORTANT SAFETY INSTRUCTIONS

READ AND SAVE THIS OWNER'S GUIDE FOR FUTURE REFERENCE.

This guide contains important safety instructions for the Freedom EX 4000 that must be followed during installation, operation, maintenance, and troubleshooting.

Read these instructions carefully and look at the equipment to become familiar with the device before operating, configuring, maintaining, and troubleshooting it. The following special messages may appear throughout this documentation or on the equipment to warn of potential hazards or to call attention to information that clarifies or simplifies a procedure.



The addition of either symbol to a "Danger" or "Warning" safety label indicates that an electrical hazard exists which will result in personal injury if the instructions are not followed.



This is the safety alert symbol. It is used to alert you to potential personal injury hazards. Obey all safety messages that follow this symbol to avoid possible injury or death.

DANGER

DANGER indicates a hazardous situation which, if not avoided, **will result in** death or serious injury.

WARNING

WARNING indicates a hazardous situation which, if not avoided, **could result in** death or serious injury.

CAUTION

CAUTION indicates a hazardous situation which, if not avoided, **could result in** minor or moderate injury.

NOTICE

NOTICE is used to address practices not related to physical injury.

Product Safety Information

1. Before using the inverter/charger/converter, read all instructions and cautionary markings on the unit, the batteries, and all appropriate sections of this guide.
2. Use of accessories not recommended or sold by the manufacturer may result in a risk of fire, electric shock, or injury to persons.
3. The inverter/charger/converter is designed to be connected to both DC and AC electrical systems. The manufacturer recommends that all wiring be done by a certified technician or electrician to ensure adherence to the local and national electrical codes applicable in your jurisdiction.
4. To avoid a risk of fire and electric shock, make sure that existing wiring is in good condition and that wire is not undersized. Do not operate the inverter/charger/converter with damaged or substandard wiring.
5. Do not operate the inverter/charger/converter if it has been damaged in any way.
6. This unit does not have any user-serviceable parts. Do not disassemble the inverter/charger/converter except where noted for connecting wiring and cabling. See your warranty for instructions on obtaining service. Attempting to service the unit yourself may result in a risk of electrical shock or fire. Internal capacitors remain charged after all power is disconnected.
7. To reduce the risk of electrical shock, disconnect both AC and DC power to or from the inverter/charger/converter before attempting any maintenance or cleaning or working on any components connected to the inverter/charger/converter. Do not disconnect under load. Turning the inverter/charger/converter to Standby using the Power button on the front panel will not reduce an electrical shock hazard.
8. The inverter/charger/converter must be provided with an equipment-grounding conductor connected to the AC input ground.
9. Do not expose this unit to rain, snow, or liquids of any type. This product is designed for dry-locations-use only. Damp environments will significantly shorten the life of this product and corrosion caused by dampness will not be covered by the product warranty.
10. To reduce the chance of short-circuits, always use insulated tools when installing or working with this equipment.
11. Remove personal metal items such as rings, bracelets, necklaces, and watches when working with electrical equipment.
12. For marine applications, this unit must be installed with a drip shield. Refer to the *Installation Guide* (doc number: 975-0998-01-01) for details.



! DANGER

ELECTRICAL SHOCK AND FIRE HAZARD

Installation must be done by qualified personnel to ensure compliance with all applicable installation and electrical codes and regulations. Instructions for installing the Freedom EX 4000 Inverter/Charger with 48VDC-to-12VDC Converter are provided here for use by qualified personnel only.

Failure to follow these instructions will result in death or serious injury.

! DANGER

HAZARD OF ELECTRIC SHOCK, EXPLOSION, BURN, OR ARC FLASH

- Apply appropriate personal protective equipment (PPE) and follow safe electrical work practices. See NFPA 70E or CSA Z462.
- This equipment must only be installed and serviced by qualified electrical personnel.
- Turn off all power supplying this equipment before working on or inside equipment.
- Always use a properly rated voltage sensing device to confirm power is off.
- Replace all devices, doors, and covers before turning on power to this equipment.
- Batteries can present a risk of electrical shock, high short-circuit current, and exposure to gasses and chemicals.
- Observe the following precautions when working with batteries:
 - Remove watches, rings, or other metal objects;
 - Keep sparks and flames away from batteries;
 - Use tools with insulated handles;
 - Do not lay tools or other metal parts on top of batteries.
- Servicing of batteries must only be performed by qualified personnel knowledgeable of batteries and the required precautions. Keep unqualified personnel away from batteries.
- Disconnect the charging source prior to connecting or disconnecting battery terminals.
- Never attempt to charge a frozen battery.

Failure to follow these instructions will result in death or serious injury.

WARNING

FIRE AND EXPLOSION HAZARD

- Unit's components may produce arcs or sparks.
- Do not install near batteries, in machinery space, or in an area in which ignition-protected equipment is required.
- For indoor use only.

Failure to follow these instructions can result in death, serious injury, or equipment damage.

WARNING

HEAVY EQUIPMENT

Always use proper lifting techniques during handling and installation. A two-person lift is required to prevent personal injury.

Failure to follow these instructions can result in death, serious injury, or equipment damage

WARNING

ELECTRICAL SHOCK HAZARD

- Replace the wiring compartment cover before turning on power to this equipment.
- Use a torque screwdriver to tighten the captive nut panel screw to 5 in-lb (0.56 N-m) torque to ensure a proper ground connection and a required tool access to the wiring compartment.

Failure to follow these instructions can result in death, serious injury, or equipment damage.

CAUTION

HAZARD OF ELECTRICAL SHOCK AND FIRE

- Do not open. No serviceable parts inside. Provided with integral protection against overloads. Bonding between conduit connections is not automatic and must be provided as part of the installation.
- Read manual before installing or using.
- Do not cover or obstruct ventilation openings.
- Do not mount in zero-clearance compartment – overheating may result.
- Do not expose to rain or spray.
- Install GFCI protection of branch circuits connected to the AC output per electrical code requirements.
- Do not connect AC OUT to any other source of power. Damage to unit may occur.
- For AC IN and AC OUT, use wires suitable for at least 75°C.

Failure to follow these instructions can result in minor or moderate injury.

NOTES:

- Follow these instructions and those published by the battery manufacturer and the manufacturer of any equipment you intend to use in the vicinity of the battery. Review cautionary markings on these products and on the engine.
- Freedom EX 4000 Inverter/Charger with 48VDC-to-12VDC Converter products are designed for deep cycle lead-acid batteries. See warning below when connecting to lithium ion batteries.
- Do not use transformerless battery chargers in conjunction with the inverter/charger/converter due to overheating.

⚠ CAUTION

LITHIUM ION BATTERY TYPE HAZARD

Make sure to use a lithium ion battery pack that includes a certified Battery Management System (BMS) with built-in safety protocols including a pre-charge contactor (see NOTE below). Follow the instructions published by the battery manufacturer.

Failure to follow these instructions can result in serious injury or equipment damage.

NOTE: A pre-charge circuit is a featured built-in contactor by some battery manufacturers which regulates inrush current from the inverter's capacitors allowing a smooth transition into full power system operation.

⚠ CAUTION

PHYSICAL INJURY HAZARD

This Freedom EX 4000 Inverter/Charger with 48VDC-to-12VDC Converter is not intended for use by persons (including children) with reduced physical, sensory, or mental capabilities or lack of experience and knowledge, unless they have been given supervision or instruction concerning use of the appliance by a person responsible for their safety. Children should be supervised to ensure that they do not play with the appliance.

Failure to follow these instructions can result in injury or equipment damage.

Precautions When Working With Batteries

IMPORTANT: Battery work and maintenance must be done by qualified personnel knowledgeable about batteries to ensure compliance with battery handling and maintenance safety precautions.

WARNING

BURN FROM HIGH SHORT-CIRCUIT CURRENT, FIRE AND EXPLOSION FROM VENTED GASES HAZARDS

- Always wear proper, non-absorbent gloves, complete eye protection, and clothing protection. Avoid touching your eyes and wiping your forehead while working near batteries. See note #4.
- Remove all personal metal items, like rings, bracelets, and watches when working with batteries. See notes #5 and #6 below.
- Never smoke or allow a spark or flame near the engine or batteries.
- Never charge a frozen battery.
- Never charge a Lithium Ion type battery with an ambient of 0 °C (-32 °F) or colder.

Failure to follow these instructions can result in death, serious injury, or equipment damage.

NOTES:

1. Mount and place the Freedom EX 4000 Inverter/Charger with 48VDC-to-12VDC Converter unit away from batteries in a well ventilated compartment.
2. Always have someone within range of your voice or close enough to come to your aid when you work near a lead-acid battery.
3. Always have plenty of fresh water and soap nearby in case battery acid contacts skin, clothing, or eyes.
4. Keep battery terminals clean from corrosion. If battery acid or corrosion deposit contacts skin or clothing, wash immediately with soap and water. If battery acid or corrosion deposit enters your eye, immediately flood it with running cold water for at least twenty minutes and have someone within range of your voice or close enough to get medical attention immediately.
5. Use extra caution to reduce the risk of dropping a metal tool on the battery. It could spark or short circuit the battery or other electrical parts and could cause an explosion. Use tools with insulated handles only.
6. Batteries can produce a short circuit current high enough to weld a ring or metal bracelet or the like to the battery terminal, causing a severe burn.
7. When removing a battery, always remove the negative terminal from the battery first for systems with grounded negative. Only use this unit in a negative (-) grounded system. This unit is not designed for a positive (+) grounded system. Make sure all loads connected to the battery and all accessories are off so you don't cause an arc.

Precautions When Placing the Unit

WARNING

FIRE HAZARD

- Do not install the inverter/charger/converter or any part of its supplied wiring in engine compartments.
- For marine installation, always locate the inverter/charger/converter away from the battery and mounted separately in a well-ventilated compartment with adequate space.

Failure to follow these instructions can result in death, serious injury, or equipment damage.

CAUTION

BURN HAZARD

Avoid touching the external surfaces as they may be hot.

Failure to follow these instructions can result in injury or equipment damage.

NOTICE

RISK OF INVERTER/CHARGER/CONVERTER DAMAGE

- Never allow battery acid to drip on the inverter/charger/converter when reading specific gravity, or filling battery.
- Never place the Freedom EX 4000 unit directly above batteries; gases from a battery will corrode and damage the inverter/charger/converter.
- Do not place a battery on top of the inverter/charger/converter.

Failure to follow these instructions can result in equipment damage.

Regulatory

The Freedom EX 4000 inverter/charger/converter is certified to appropriate US and Canadian standards. For more information see *Regulatory approvals on page 64*.

The Freedom EX 4000 inverter/charger/converter is intended to be used for recreational, commercial, or other mobile applications. This inverter/charger/converter is designed for marine applications only when additional drip protection is installed in certain orientations. See the *Installation Guide (doc number: 975-0998-01-01)* for information.

FCC (EMI) Information to the User

This equipment has been tested and found to comply with the limits for a Class B digital device, pursuant to part 15 of the FCC / CAN ICES-003 Rules. These limits are designed to provide reasonable protection against harmful interference in a residential environment. This equipment generates, uses, and can radiate radio frequency energy and, if not installed and used in accordance with the instructions, may cause harmful interference to radio communications.

However, there is no guarantee that interference will not occur in a particular installation. If this equipment does cause harmful interference to radio or television reception, which can be determined by turning the equipment off and on, the user is encouraged to try to correct the interference by one or more of the following measures:

- Reorient or relocate the receiving antenna.
- Increase the separation between the equipment and receiver.
- Connect the equipment into an outlet on a circuit different from that to which the receiver is connected.
- Consult the dealer or an experienced radio/TV technician for help.

CAUTION

Unauthorized changes or modifications to the equipment could void the user's authority to operate the equipment.

End of Life Disposal

The Freedom EX 4000 Inverter/Charger with 48VDC-to-12VDC Converter is designed with environmental awareness and sustainability in mind. At the end of its useful life, the Freedom EX 4000 can be decommissioned and disassembled. Components which can be recycled must be recycled and those that cannot be recycled must be disposed of according to local, regional, or national environmental regulations.

Many of the electrical components used in the Freedom EX 4000 Inverter/Charger with 48VDC-to-12VDC Converter are made of recyclable material like steel, copper, aluminum, and other alloys. These materials can be auctioned off to traditional scrap metal recycling companies who resell reusable scraps.

Electronic equipment such as the circuit boards, connectors, and fuses can be broken down and recycled by specialized recycling companies whose goal is to avoid having these components end up in the landfill.

For more information on disposal, contact Xantrex.



This page is intentionally left blank. [2]

CONTENTS

Important Safety Instructions	<i>V</i>	Power Save Mode	<i>18</i>
Precautions When Working With Batteries	<i>xi</i>	Checking Battery Status	<i>19</i>
Precautions When Placing the Unit	<i>xii</i>	Checking Output Power	<i>19</i>
Regulatory	<i>xii</i>	Operating Several Loads at Once	<i>20</i>
FCC (EMI) Information to the User	<i>xiii</i>	Operating During Transition Between Shore Mode and Battery Mode	<i>21</i>
End of Life Disposal	<i>xiii</i>	Transitioning from Shore Mode to Battery Mode	<i>21</i>
Introduction	<i>1</i>	Transitioning from Battery Mode to Shore Mode	<i>22</i>
Materials List	<i>2</i>	Operating Limits	<i>23</i>
Key Features	<i>2</i>	Inverter Power Output	<i>23</i>
Features	<i>7</i>	DC-to-DC Converter Power Output	<i>23</i>
AC/DC Panel	<i>8</i>	Input Voltage	<i>24</i>
Communications Panel	<i>10</i>	Overload Conditions	<i>25</i>
LED Panel	<i>12</i>	High Surge Loads	<i>26</i>
Operation	<i>13</i>	Over-temperature Conditions	<i>26</i>
LED Status Indicators and Power Button	<i>14</i>	Configuration	<i>27</i>
Operating in Battery Mode	<i>16</i>	Freedom EX 4000 Remote Display Panel	<i>28</i>
Turning Inverter Operation ON and OFF	<i>16</i>		
Search Mode	<i>17</i>		

Function Buttons	28
LCD Screen	29
LCD Screen Icons	29
Adjusting Settings in Configuration Mode	31
General Settings	32
Routine Maintenance	43
Maintaining the Freedom EX 4000 Unit	44
Troubleshooting	45
Pre-service Checklist	46
Inverter Applications	47
Resistive Loads	47
Motor Loads	47
Problem Loads	48
Warning Messages	49
Troubleshooting Reference	56
Specifications	59
Environmental Specifications	60
System Specifications	60
Regulatory Approvals	64

1 INTRODUCTION

The Freedom EX 4000 Inverter/Charger with 48VDC-to-12VDC Converter is designed with integrated inverting and charging functions and power management features suitable for marine, recreational, and commercial/fleet vehicle installations.

Please read this section to familiarize yourself with the main performance and protection features of the Freedom EX 4000.

This section includes:

Materials List	2
Key Features	2

Materials List

The Freedom EX 4000 base package includes the following items.

1	Freedom EX 4000
2	Installation guide
3	pair of ½" bushings
4	pair of ¾" bushings
5	one network terminator

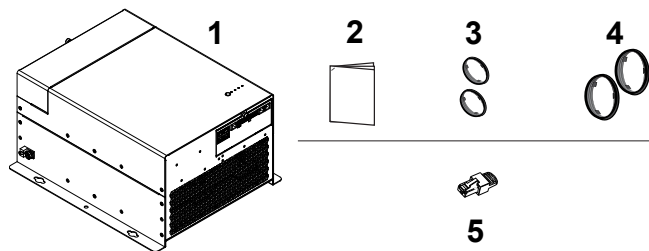

Figure 1 Materials List

NOTE: If any of the items are missing, contact Xantrex or any authorized Xantrex dealer for replacement. See *Accessories on page 1*.

IMPORTANT: Keep the carton and packing material in case you need to return the inverter/charger/converter for servicing.

Key Features

Power for Most Appliances

The Freedom EX 4000 inverter/charger/converter provides up to 4000 watts^a of continuous utility grade, sine wave power derived from a battery bank. It is designed to handle loads such as microwave ovens, TVs, DVD/Blu-ray players, and power tools. In addition, the Freedom EX 4000's high-surge capability lets you handle many hard-to-start loads, including a full size residential refrigerator and air conditioning unit.

The built-in transfer switch automatically transfers between inverter power and shore power from recreational facilities such as boat docks or campsites to ensure power is always available.

^a As the ambient temperature rises above 40°C, the output power capability will reduce to below 4000W until the over temperature shutdown occurs.

**Back-up
Capability**

If incoming shore power is interrupted by external events like brownouts, the Freedom EX 4000 automatically becomes an independent power source^b that supplies utility grade AC power to your loads.

**Comprehensive
Protection**

The Freedom EX 4000's built-in protection features safeguard your batteries (from unnecessary drain) such as the following:

- **Selectable Low Battery Shutdown:** The low battery shutdown for the inverter/charger/converter can be manually selected by the user from 36.0 to 48.0 VDC.
- **Low Voltage Shutdown Delay Timer:** Configurable from 0 to 600 seconds to reduce an unnecessary shutdown of inverter operation such as during cranking or other brief but heavy discharge of battery.
- **Inverter Search Mode:** Search mode allows the inverter to selectively power only items that draw more than a certain amount of power, which can result in energy savings. The Freedom EX 4000 has a no-load power draw of about 30 watts. Enabling search mode reduces this power draw to less than 5 watts. For more information, see *Search Mode on page 17*.

^b Assuming the inverter/charger/converter is connected to a battery source with an adequate charge at the time of the power interruption.

Overload Alarm and Shutdown

During Battery Mode (also called Inverter Mode), the Freedom EX 4000 automatically alerts you if the loads that are connected and drawing power from the unit are close to approaching the maximum operating limit. If so, inverting and/or charging operation is temporarily shut down when the maximum operating limit is exceeded to prevent overheating. Inverting and/or charging operation resumes when the shutdown error is cleared. See *Troubleshooting Reference on page 56* for precautions.

Over temperature Alarm and Shutdown

During Battery Mode, the Freedom EX 4000 automatically alerts you if it is overheating and approaching the over-temperature shutdown limit. Inverting and/or charging operation is temporarily shut down when the limit is exceeded until the shutdown error is cleared. See *Troubleshooting Reference on page 56* for precautions.

Built-in Charge Formulas

For the inverter/charger/converter to perform at the highest level, the batteries must be charged correctly. The Freedom EX 4000 has optimized algorithms for flooded, gel, AGM, and Custom batteries, and lithium iron phosphate [LFP (or LiFePO_4)] Xantrex Batteries.

Manual Equalization (for Flooded, vented lead-acid batteries)

Over a period of time, the cells in a flooded battery can develop uneven chemical states. This can result in a weak (undercharged) cell which, in turn, can reduce the overall capacity of the battery. To improve the life and performance of a non-sealed, flooded battery, the Freedom EX 4000 multi-stage charging cycle includes a manual equalize mode that can be used, if recommended by the battery manufacturer.

Ignition Control

The Freedom EX 4000 provides two user-selectable options for ignition control:

- **Ignition Lockout:** The Freedom EX 4000 features the ability to inhibit the inverter/charger/converter from operating in the absence of a voltage signal from a vehicle's ignition circuit. This is particularly useful if the inverter/charger/converter is required to operate only when a vehicle's engine is running.
- **Ignition Auto-on:** The Freedom EX 4000 can automatically turn the inverter/charger/converter on and off in tandem with the vehicle's ignition circuit or a manually operated remote switch.

Configurable AC Output Voltage

The Freedom EX 4000 is factory set to 60 Hz AC output frequency and 120 V AC output voltage. The AC output voltage setting can be configured between 105 and 130 volts.

Load Management

The Freedom EX 4000 has a built-in 50A transfer relay that connects the inverter output or AC input from the AC source to the loads. AC power sources are from the grid (shore) usually or from a small generator which often have limited current availability. Thus, having the capability to manage your AC loads is extremely valuable. The Freedom EX 4000 provides a number of features to facilitate this.

- The charger is power factor corrected to use AC current as efficiently as possible. Minimizing the AC current used by the charger means more current is available for your AC loads.
- The Freedom EX 4000 has a power share feature which prioritizes your AC loads by reducing the charge current and maintaining the total input current to less than the breaker setting.

Materials List

Split-phase Inverter capability In Battery (or Inverter) Mode, a single Freedom EX 4000 can only produce a single phase 60Hz 120V AC output voltage configurable between 105 and 130 volts. For installations that require 60Hz 240V AC output voltage in Battery (or Inverter) Mode, two Freedom EX 4000 inverter units are required. The AC output voltage setting of the stacked pair can be configured between 210 and 260 volts.

DC Power Supply (12 VDC) DC voltage up to 13.5 volts and DC current up to 45 amps are used to power many DC-rated appliances and electronic equipment for communication, lighting, refrigeration, and other auxiliary devices.

Stacking Features See the *Installation Guide (doc number: 975-0998-01-01)* for information on how to stack two units together for more power options.

NOTE:

Contact Xantrex prior to stacking two Freedom EX 4000 units together. Stacking configuration via USB is a required step to enable stacking.

2 FEATURES

This section identifies the default settings and the hardware features of the Freedom EX 4000 Inverter/Charger with 48VDC-to-12VDC Converter. This section includes:

AC/DC Panel	8
Communications Panel	10
LED Panel	12

AC/DC Panel

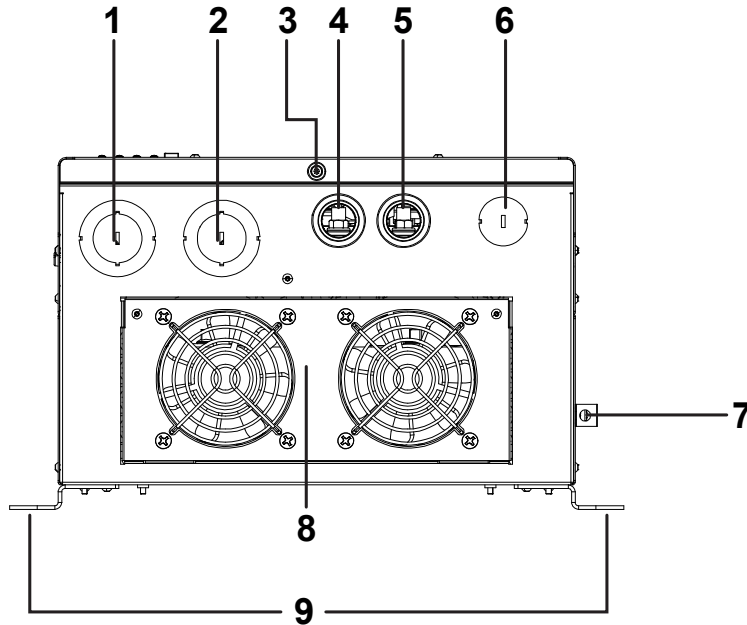

Figure 2 AC/DC Panel

⚠ WARNING

ELECTRICAL SHOCK HAZARD

Use a torque screwdriver to tighten the captive nut panel screw to 5 in-lb (0.56 N-m) torque of force to ensure a proper ground connection and a required tool access to the wiring compartment.

Failure to follow these instructions can result in death, serious injury, or equipment damage.

Table 1 AC/DC Panel Features

Feature	Description
1	AC input terminal opening for routing AC input wiring.
2	AC output terminal opening for routing AC output wiring.
3	Captive nut panel screw holds the wiring compartment cover in place. See WARNING above. Wiring compartment cover protects the wiring compartment from debris, keeps the cables secure, and protects the user from accidental contact with live wires. Using the captive nut panel screw, the cover can be opened and lifted out during wiring. See WARNING on this page.

Feature	Description
4	DC terminal opening for routing (–) negative DC cable for inverting from or charging a 48V battery.
5	DC terminal opening for routing (+) positive DC cable for inverting from or charging a 48V battery.
6	Single opening to two DC output terminals for routing (–) negative and (+) positive DC cables for 12V DC loads. ⚠ Do not use for charging. Do not stack or parallel with other DC output terminals. Call Xantrex customer support for options.
7	Grounding lug provides a ground path for the Freedom EX 4000 chassis to the DC system ground. See WARNING.
8	Cooling fans turn on when the internal temperature reaches a set point temperature.
9	Mounting flanges on both sides allow you to mount the inverter/charger/converter permanently on the interior deck or on a wall.

WARNING

ELECTRICAL SHOCK HAZARD

- Use a torque screwdriver to tighten the bolt on the DC ground lug to a torque of 23 in-lb (2.6 N-m) of force.
- Apply an anti-corrosion compound to the copper wire prior to connecting to the DC ground lug.

Failure to follow these instructions can result in death, serious injury, or equipment damage.

Communications Panel

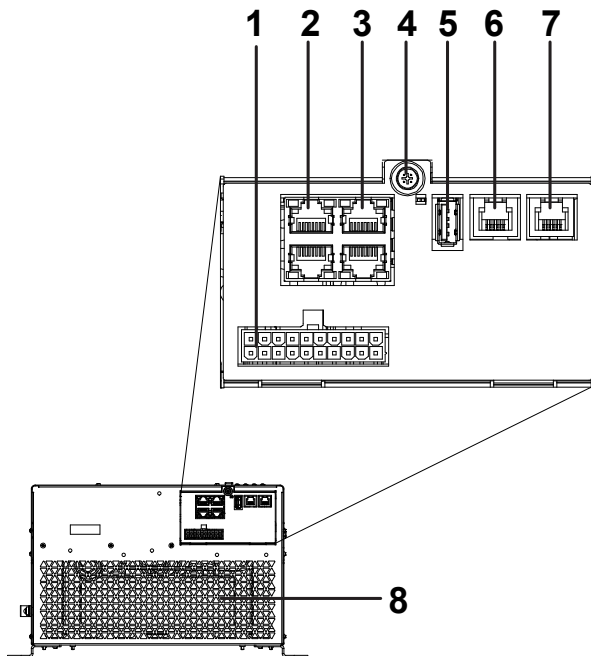

Figure 3 Communications Panel

⚠ WARNING

ELECTRICAL SHOCK HAZARD

Use a torque screwdriver to tighten the captive nut panel screw to 5 in-lb (0.56 N-m) torque of force to ensure a proper ground connection and a required tool access to the wiring compartment.

Failure to follow these instructions can result in death, serious injury, or equipment damage.

Table 2 Communications Panel Features

Feature	Description
1	20-pin CC (communications and control) port connects with the optional Communications and Control 20-pin Harness (sold separately).
2	RV-C ports. Use the top and bottom ports to connect an RV-C ^a device.
3	Sync ports. Use either top or bottom ports to connect a second Freedom EX 4000 Inverter/Charger with 48VDC-to-12VDC Converter unit for series or parallel stacking.

^a RV-C is a communications protocol based on the Controller Area Network (CAN) bus protocol. RV-C is used primarily in the control, coordination, and diagnostics of multi-branded equipment in recreational vehicles.

Feature	Description
4	Captive nut panel screw holds the wiring compartment cover in place. See WARNING above.
5	USB port can only be used for updating the unit's firmware. ⚠ Do not use for powering or charging USB devices.
6	Remote port allows you to connect the Freedom EX Remote Panel (PN: 808-0817-03) (sold separately) which is a remote display and control device accessory.
7	BTS port can be used for plugging in a battery temperature sensor (BTS (PN: 808-0232-01), sold separately).
8	Ventilation grille is to vent out warm air inside the unit

LED Panel

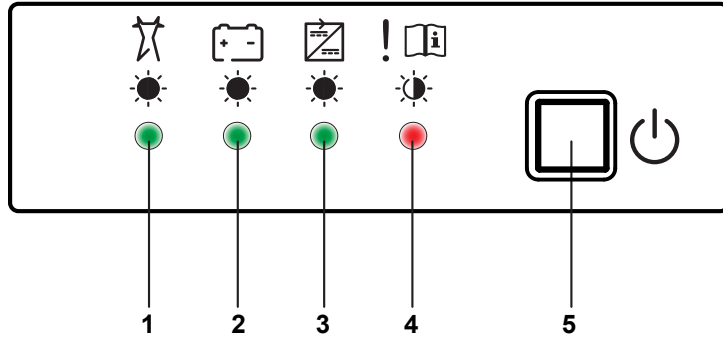

Figure 4 Display Panel

Table 3 LED Indicator Panel Features

Item	Name
1	AC source LED (shore power)
2	Inverter LED (house power)
3	DC-DC Converter LED (12 VDC output)
4	Alert LED
5	Power [Standby] button

NOTE: For more information, see *LED Status Indicators and Power Button* on page 14.

3 OPERATION

This section includes descriptions of the different modes and settings of the Freedom EX 4000 Inverter/Charger with 48VDC-12VDC Converter. This section includes:

LED Status Indicators and Power Button	14	Overload Conditions	25
Operating in Battery Mode	16	High Surge Loads	26
Turning Inverter Operation ON and OFF	16	Over-temperature Conditions	26
Search Mode	17		
Power Save Mode	18		
Checking Battery Status	19		
Checking Output Power	19		
Operating Several Loads at Once	20		
Operating During Transition Between Shore Mode and Battery Mode	21		
Transitioning from Shore Mode to Battery Mode	21		
Transitioning from Battery Mode to Shore Mode	22		
Operating Limits	23		
Inverter Power Output	23		
DC-to-DC Converter Power Output	23		
Input Voltage	24		

LED Status Indicators and Power Button

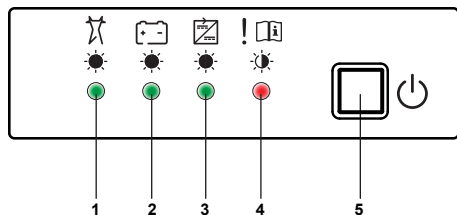







Figure 5 LED Panel

Table 4 LED Indicator Panel Features

Item	LED Name	Steady 	Flashing 	Off 
1	AC source LED (shore power)	Shore mode means that qualified AC source is present, such as when connected to a reliable shore power source like grid or generator. AC power is passed through to the load and/or charging the battery.	n/a	AC source is not connected.
2	Inverter LED (house power)	Battery mode or Inverter mode is enabled and the unit is inverting power from the house battery.	n/a	Battery is not connected.

Item	LED Name	Steady 	Flashing 	Off 
3	DC/DC Converter LED	The 48VDC-to-12VDC converter function is enabled.	n/a	The 48VDC-to-12VDC converter function is disabled.
4	Alert LED	An event condition such as ground fault or error is detected requiring attention and user intervention. Inverter and/or charging operation stops until the user is able to remedy the event condition and clear the Alert LED using the optional Freedom EX Remote Panel (PN: 808-0817-03). See also <i>Event codes displayed on the LCD screen on page 50</i> and <i>Clear Faults and Warnings on page 41</i> .	An event condition, such as a warning is detected but does not require user intervention. Inverter and/or charging operation may temporarily stop but resumes when the event condition recovers by itself.	No events are detected.
5	Power [Standby] button	Press to switch to Battery/Inverter mode when shore power is not present and the house battery is sufficiently charged. When in Shore mode, the button has no function. It does not control AC power from being passed-through to the load. Charger mode turns on automatically and operates in parallel with Shore mode when shore power is qualified and the battery is not fully charged.		

NOTE: Shore power refers to the AC input power from a utility grid, generator or external AC source. An event occurs when the unit detects a condition such as an overload, over-temperature, or a ground fault. An event can recover automatically or manually with user intervention.

Operating in Battery Mode

The Freedom EX 4000 is in Battery Mode (also called Inverter Mode) when all the following conditions exist:

- inverter power button is ON



- shore power is not presently available
- battery is sufficiently charged

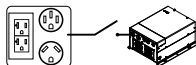

Inverter operation means that DC battery power is presently being converted to utility grade AC power, powering equipment and appliances connected to the AC output terminal of the unit. The green status LED lights up to indicate the Freedom EX 4000 is using the battery to power the equipment and appliances.

	Battery mode
	Inverter mode

Turning Inverter Operation ON and OFF

There are two ways to operate the Freedom EX 4000's inverter function.

1. Press the Power button to a down position (it is in Standby in the up position).
2. Press the Power button on the Freedom EX Remote Panel (PN: 808-0817-03).

Table 5 Inverter mode operation

Power button on unit	Power button on Freedom EX Remote Panel (PN: 808-0817-03)	Battery/ Inverter mode
		On
		On
		On
		Off [Standby]

WARNING

ELECTRICAL SHOCK HAZARD

Turning the Power  button to Standby does not disconnect DC battery power from the Freedom EX 4000. You must disconnect from all power sources before working on any circuits connected to the unit.

Failure to follow these instructions can result in death, serious injury, or equipment damage.

To prevent unnecessary battery discharge, press the Power button to Standby when you are not using the Freedom EX 4000.

Search Mode

What is Search mode

When a single Freedom EX 4000 Inverter/Charger with 48VDC-to-12VDC Converter has search mode enabled, the inverter sends electrical search pulses through its AC output. These search pulses look for connected AC loads. The delay between search pulses is set using the Search Delay setting. After a load larger than the Search Threshold setting is detected, the inverter starts producing AC output.

When to set up Search mode

The search mode feature is only valuable if the inverter can spend a fair amount of time “sleeping” each day. Therefore, if search mode is to be used it must be adjusted properly. The initial adjustment should be made so that the Freedom EX 4000 comes on only when needed.

Certain types of loads can cause search mode to work improperly. These types of loads are described in *Problem Loads on page 48*. If these kinds of loads are in the system, follow the suggestions given to resolve the problem.

Operating in Battery Mode

If the problem loads cannot be resolved, there are two workaround solutions:

Disable search mode from the main Freedom EX 4000 Setup menu, causing the inverter to remain at full output voltage.

Use a search friendly companion load whose only purpose is to be switched on to wake up the inverter to power the load that is unable to bring the inverter out of search mode.

Stacked units

Search mode must be enabled when parallel stacking. See *Search Mode General Settings on page 32*. Search mode is not supported in series stacking.

NOTE: Search mode, by function, cannot work with clocks and timers or devices that need power 24 hours a day. Examples of devices with timers include video recorders, coffee makers with brew timers, refrigerators, and freezers with defrost timers. Examples of devices that need power 24 hours a day include telephone answering machines, alarm systems, motion detection lights, and some thermostats.

When the inverter is searching the output for loads, lights that have a wattage lower than this setting may flash momentarily.

Power Save Mode

When enabled, power save mode can reduce tare loss from the battery by reducing the output from 120 volts to 108 volts when the loads are consuming less than 100 watts. When the Freedom EX 4000 detects loads higher than 100 watts, it produces the full 120 volts. Power save mode is disabled by default.

Checking Battery Status

During inverter operation (in battery mode), sufficient battery capacity is indicated by a steady DC source LED. A low battery capacity is indicated as an event condition on the LED panel with the Alert LED flashing as shown below.

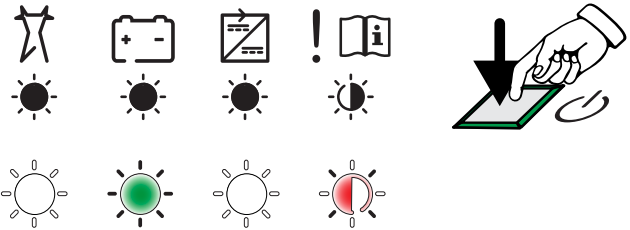

The normal operating battery voltage range is between 44 and 60 volts.

Checking Output Power

When the inverter/charger/converter is operating in battery mode, inverter power is indicated by a steady Inverter LED as shown below.

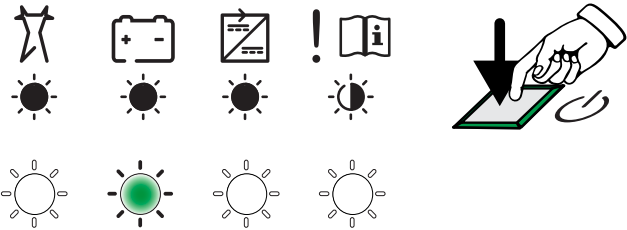

Operating Several Loads at Once

If you are going to operate several loads from the Freedom EX 4000, turn them on one at a time after you have turned the inverter/charger/converter on.

Turning loads on separately helps to ensure that the inverter/charger/converter does not have to deliver the starting current for all the loads at once, and will help prevent an overload shutdown.

Operating During Transition Between Shore Mode and Battery Mode

The Freedom EX 4000's advanced power management is capable of transitioning power from an AC source to DC source within a fraction of a second and vice-versa.

The Freedom EX 4000 automatically detects when shore power is present and when it becomes unavailable or drops to less than the AC Voltage Shutdown level or if AC frequency goes out-of-range.

Operating During Transition Between Shore Mode and Battery Mode

Transitioning from Shore Mode to Battery Mode

When the unit is operating in shore mode and shore power is lost, the Freedom EX 4000 has less than 20 milliseconds (default) to switch to operating in battery mode (if the Power button is pressed in the On position) and starts drawing power from the battery.

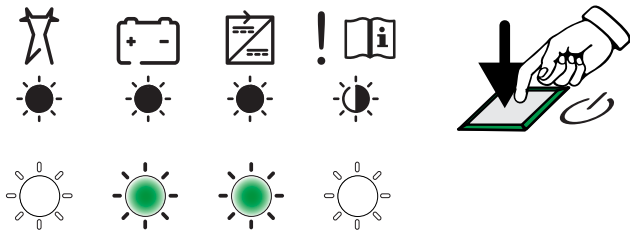

The Inverter LED lights up. However, if the Power button is in Standby, this transition does not happen.

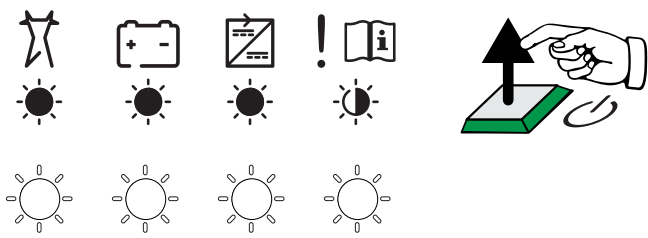

Transitioning from Battery Mode to Shore Mode

When the unit is operating in Battery Mode and shore power becomes available, the Freedom EX 4000 begins a 20-second countdown to verify the stability of the shore power. If shore power remains stable for a 20-second countdown, at the end of the countdown, the Freedom EX 4000 will switch to shore power mode within 20 milliseconds and start drawing power from the AC source.

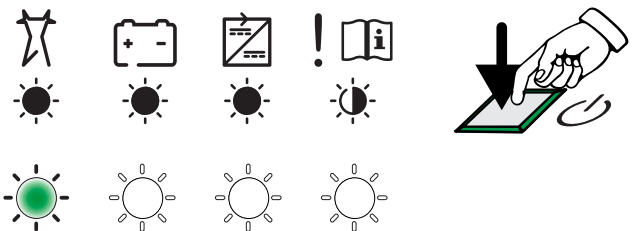

The AC source LED lights up and the Inverter LED turns off.

Operating Limits

These are the operating limits of the Freedom EX 4000:

- *Inverter Power Output*
- *DC-to-DC Converter Power Output*
- *Input Voltage*
- *Overload Conditions*
- *High Surge Loads*
- *Over-temperature Conditions*

Inverter Power Output

The Freedom EX 4000 can deliver up to 4000 watts of continuous utility grade sine wave AC power. The wattage rating applies to resistive loads such as a heater element.

DC-to-DC Converter Power Output

The Freedom EX 4000's 48VDC to 12VDC converter can deliver up to approximately 607 watts independent of the unit's inverter power output. The wattage rating is based on 13.5V of maximum DC output at 45A continuous current.

Operating Limits

Input Voltage

The allowable Freedom EX 4000 input battery voltage ranges are shown in the following table:

Table 6 Input battery voltage range



Operating Condition	Battery Voltage	Comment
Full Operating Range	LBCO – 64.0 volts	Assuming the battery is full, the inverter/charger/converter will operate until battery voltage goes past below LBCO ^a and LBCO Shutdown delay timer ^b .
Low Voltage Recovery	> LBCO + LBCO Hysteresis volts ^c	Inverter is able to recover and continue to operate.

^a To set LBCO, see *Adjusting Settings in Configuration Mode* on page 31.

^b To set LBCO Shutdown Delay Timer, see *Input Voltage* on page 24.

^c 6.0 volts is the default LBCO Hysteresis value. The range is from 0.0 to 10.0 volts.

Operating Condition	Battery Voltage	Comment
Low Voltage Shutdown	< LBCO	If installed, the display on the Freedom EX Remote Panel (PN: 808-0817-03) shows error code $E\Box I$ and the buzzer sounds a single one-second low battery alarm beep. After LBCO Shutdown delay timer runs out, the unit shuts down inverter output. The buzzer stops beeping and the display on the Freedom EX Remote Panel (PN: 808-0817-03) shows error code $E\Box I$.
Instant Low Voltage Shutdown	< 32.0 volts	After two seconds below the limit, the unit shuts down inverter output completely.

Operating Condition	Battery Voltage	Comment
High Voltage Shutdown	> 64.0 volts ^d	<p>If installed, the display on the Freedom EX Remote Panel (PN: 808-0817-03) shows error code $E02$ alternating with the battery voltage.</p> <p>The Event LED turns on.</p> <p> </p> <p></p> <p>NOTE: Although the Freedom EX 4000 incorporates over-voltage protection, it can still be damaged if input voltage exceeds 64.0 volts.</p>

^d The range is from 58.0 to 70.0 volts.

Overload Conditions

There are two kinds of overload conditions – an overload warning and an overload shutdown. A warning will not stop the unit from inverting but after a sustained overload the inverter shuts down.

NOTE: The audible alarm is a feature of the Freedom EX Remote Panel (PN: 808-0817-03). Without the remote panel, there is no alarm indication with sound only visual from the LEDs on the unit.

Loads connected to the inverter are seldom constant, and large loads are often operated for short periods. To accommodate larger loads, the Freedom EX 4000 can temporarily exceed its continuous output power rating.

The graph in *Figure 6* illustrates approximate operation time versus load. inverter operation time during overload is limited by both inverter internal temperature protection and by the product of AC output current and elapsed time.

Figure 6 Overload characteristics

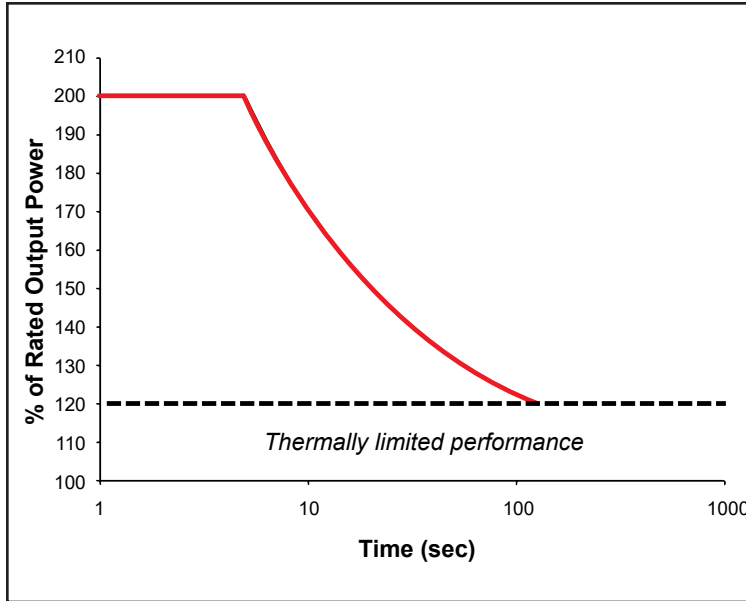

High Surge Loads

Some induction motors used in freezers, pumps, and other motor-operated equipment require high surge currents to start. The Freedom EX 4000 may not be able to start some of these motors even though their rated steady state current draw is within the inverter/charger/converter's limits. The unit will shut down and indicate an overload shutdown.

Over-temperature Conditions

During inverter operation, when the Freedom EX 4000's internal temperature starts to approach its preset shutdown limit, if installed, the display on the Freedom EX Remote Panel (PN: 808-0817-03) will show error code *E07*. The Event LED will flash.

If the over-temperature condition persists, if installed, the display on the Freedom EX Remote Panel (PN: 808-0817-03) will show error code *E04*. The Event LED will turn on and the inverter/charger/converter will shut down to prevent damage to the inverter/charger/converter and protect the battery from being over-discharged.

4 CONFIGURATION

This section includes descriptions on how to change the various settings of the Freedom EX 4000 Inverter/Charger with 48VDC-to-12VDC Converter using the optional Freedom EX Remote Panel (PN: 808-0817-03). This section includes:

Freedom EX 4000 Remote Display Panel	28
Function Buttons	28
LCD Screen	29
LCD Screen Icons	29
Adjusting Settings in Configuration Mode	31
General Settings	32





IMPORTANT: The Freedom EX 4000 Inverter/Charger with 48VDC-to-12VDC Converter can be configured using the Freedom EX Remote Panel (PN: 808-0817-03) which is sold separately. To order, contact Xantrex or your Xantrex dealer and reference the product number for Freedom EX Remote Panel (PN: 808-0817-03) with 25-ft (7.6 m) network cable.

NOTE: Settings are subject to change without prior notice.

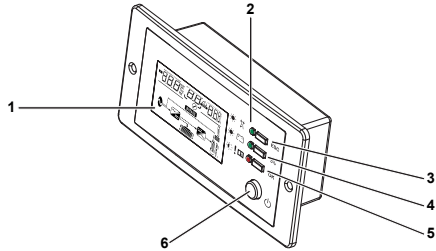
Freedom EX 4000 Remote Display Panel





Figure 7 Display Panel



1	LCD screen
2	Status LED indicators
3	 see "Function Buttons" below
4	 see "Function Buttons" below
5	 see "Function Buttons" below
6	 see "Function Buttons" below

NOTE: Briefly pressing any function button activates backlight illumination. After 60 seconds of inactivity, backlight illumination turns off.

Function Buttons

Button	Definition
	Return to default screen or exit setting mode.
	Scroll to next screen or next selection. Press and hold for three seconds to scroll back one step.
	To enter the Configuration mode or to confirm the setting.
	Turns on inverter/charger/converter operation or to Standby.

LCD Screen

The LCD Screen changes depending on the operating mode of the inverter/charger/converter.

Figure 8 Parts of the LCD Screen

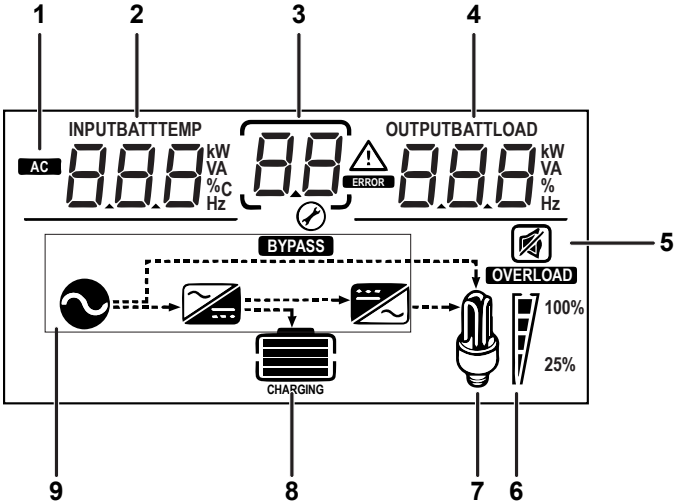







1	AC IN or AC OUT indicator	6	load power level indicator
2	left part of LCD display	7	load indicator
3	middle part of LCD display	8	battery level indicator
4	right part of LCD display	9	mode indicator
5	alarm off indicator		

LCD Screen Icons

Icon	Definition
	AC input and output indicator.
	The wrench icon underneath a number is displayed during configuration mode.
	An error event with its corresponding number is displayed here.
	A warning event with its corresponding number is displayed here.
	The charging indicator is displayed when the unit is in charger mode.
	The battery icon indicates remaining battery power. One bar = 1-25%, two bars = 25-50%, three bars = 50-75%, and four bars = 75-100%.
	Shows an overload condition.

Freedom EX 4000 Remote Display Panel

Icon	Definition
	The load icon is displayed if there is voltage available at the AC output.
	The bar represents load consumption levels. 100% is an indication of full capacity and 25% indicates low consumption. All the bars disappear at < 20 watts, and AC load indicates zero watt power.
	Shows up in grid mode when AC shore power is present. If the power is being qualified, then this icon will flash.
BYPASS	Shows that the unit is in grid mode and is bypassing shore power directly to the loads.
	Shows up in shore mode when AC shore power is present. If the power is being qualified, then this icon will flash.
BYPASS	Shows that the unit is in shore mode and is bypassing shore power directly to the loads.

Icon	Definition
	This icon shows when there is power conversion from AC to DC - charging.
	This icon shows when there is power conversion from DC to AC - inverting.
	The alarm buzzer is muted.

Adjusting Settings in Configuration Mode

The **OK**, Scroll , and **ESC** buttons can be used to cycle through the various settings:

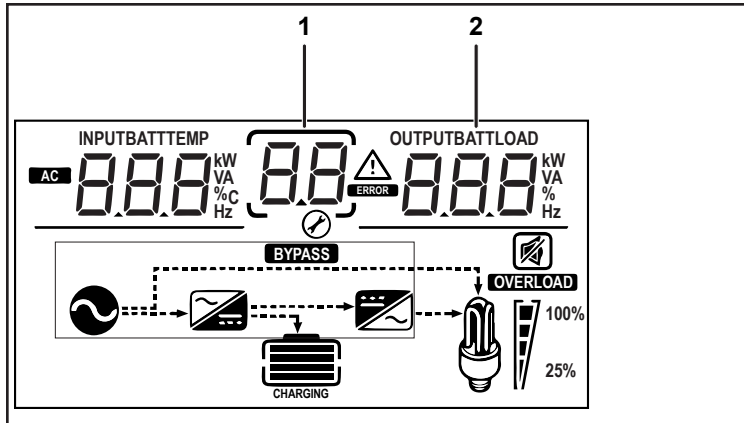

1. Press and hold the **OK** button for three seconds to enter Configuration mode and change general settings. Press the **OK** button to enter sub-settings, if applicable.
2. Press the Scroll  button to scroll through the different settings. Press and hold for three seconds to scroll back one step.



1	setting number is displayed here
2	setting value is displayed here

To change the default value to a different value:

NOTE: In order for changes to be saved properly into the Freedom EX 4000's onboard memory, you must wait at least 10 minutes after you have made a change before disconnecting from AC and DC sources. In some circumstances when you need to immediately disconnect the Freedom EX 4000 from AC and DC power sources, be sure to turn off the Freedom EX 4000 using the Power button (see *Turning Inverter Operation ON and OFF on page 16*) prior to disconnection so that the changes are made permanent.

1. Press and hold the **OK** button for three seconds to enter the Configuration mode.
2. Press the Scroll  button to scroll through the different settings. Press and hold for three seconds to scroll back one step.
3. Press the **OK** button to select a general setting and change its value. Also press, to select a sub-setting, if applicable.
4. Press the Scroll  button to change the value until you reach the desired value. Press and hold for three seconds to scroll back one step.
5. Press the **OK** button to confirm the change.
6. Repeat the previous steps to set other settings.
7. Press the **ESC** button to exit the Configuration mode.

General Settings

NOTE: See *Abbreviations and Acronyms* on page iv.

Setting Name	Setting Number	Default Value	Range of Values	Unit	Step	Description
Inverter Mode Battery Mode	01	10E (enable)	10E (enable) 10d (disable)	--	--	Enables or disables Invert mode also known as Battery mode. When enabled and when the battery is sufficiently charged, the Freedom EX 4000 converts battery power to AC power.
Search Mode	02	d1 5 (disable)	d1 5 (disable) EnA (enable)	--	--	Enables or disables Search mode also known as load sensing mode. When enabled, the Freedom EX 4000's "no load" loss can be reduced further when the total load is less than the Search threshold setting. Enable Search mode in parallel stacking*. Search mode is not supported in series stacking*. <small>* Contact Xantrex prior to stacking two Freedom EX 4000 units together. Stacking configuration via USB is a required step to enable stacking.</small>
AC Breaker Rating	03	50.0	3.0 to 50.0	A	1.0	The load share feature prioritizes the AC load by reducing the charge current in order to maintain the total input current to less than the Load share setting.

Setting Name	Setting Number	Default Value	Range of Values	Unit	Step	Description
Charger Mode	04	<i>CH</i> E (enable)	<i>CH</i> E (enable) <i>CH</i> d (disable)	--	--	Enables or disables Charger mode. When enabled and when AC source power is present and qualified, the Freedom EX 4000 charges the connected battery until fully charged.
Force Charge	05	<i>FC</i> 0	<i>FC</i> 0 (no effect) <i>FC</i> 1 (force bulk stage) <i>FC</i> 2 (force float stage)	--	--	Forces the charging algorithm to a specific stage. Not applicable when <i>LFP</i> battery type is selected.
Equalization Support	06	<i>dI</i> 5 (disable)	<i>En</i> A (enable) <i>dI</i> 5 (disable)	--	--	Enables or disables Equalization charging. Not applicable when <i>LFP</i> battery type is selected.
DC-to-DC Converter	07	<i>dCE</i> (enable)	<i>dCE</i> (enable) <i>dCd</i> (disable)	--	--	Enables or disables the DC/DC Converter which powers the 12VDC output terminals.
Ignition Control	08	<i>OFF</i>	<i>OFF</i> (disabled) <i>LOt</i> (ignition lock out) <i>Aut</i> (ignition auto on)	--	--	Selects an Ignition Control setting to off, ignition lock out, or ignition auto on. These features are described in <i>Ignition Control on page 5</i> .

Adjusting Settings in Configuration Mode

Setting Name	Setting Number	Default Value	Range of Values	Unit	Step	Description
Charger settings	<i>CH</i>		Press the OK button to access the sub-settings.	--	--	For sub-settings, see <i>Charger Sub-settings on page 35</i> .
Inverter settings	<i>IN</i>			--	--	For sub-settings, see <i>Invert Sub-settings on page 37</i> .
Custom settings	<i>CU</i>			--	--	For sub-settings, see <i>Custom Sub-settings on page 39</i> .
AC settings	<i>AC</i>			--	--	For sub-settings, see <i>AC Sub-settings on page 40</i> .
Device settings	<i>DE</i>			--	--	For sub-settings, see <i>Device Sub-settings on page 41</i> .

Charger Sub-settings

Setting Name	Setting Number	Default Value	Range of Values	Unit	Step	Description
Battery Type	<i>C1</i>	<i>FLd</i>	<i>FLd</i> (Flooded), <i>9EL</i> (Gel), <i>USE</i> (Custom), <i>LFP</i> (LiFePO ₄), <i>AGn</i> (AGM),	--	--	Sets the corresponding battery type to the actual battery used in the power system. <i>LFP</i> (LiFePO ₄) is a pre-set battery type that requires a compatible Xantrex Battery with BMS. Other lithium-ion batteries with BMS should be set as <i>USE</i> (Custom) battery type with parameters set according to the battery manufacturer's specifications.
Battery Capacity	<i>C2</i>	<i>10</i>	<i>0</i> to <i>300</i>	Ah	1 (0-10) 10 (10-300)	Sets the battery capacity of the system. The value displayed must be multiplied by a factor of 10 for the real value. For example, the default 100Ah is displayed as <i>10</i> , 1200Ah will show as <i>120</i> , 10Ah will show as <i>1</i> .
Maximum Charge Current	<i>C3</i>	<i>80</i>	<i>4</i> to <i>80</i>	A	1	Sets the maximum DC output current that is available to the charger.

Adjusting Settings in Configuration Mode

Setting Name	Setting Number	Default Value	Range of Values	Unit	Step	Description
Charge Cycle	C4	35t	35t (3-stage) uLL (CVCC) 25t (2-stage)	--	--	Sets the charging method to either 3-stage, constant voltage constant current, or 2-stage. Not applicable when LFP battery type is selected.
Recharge Voltage	C5	50.0	(LBCO or) 44.0 to 56.0	V	0.1	Sets the battery voltage level at which a new charge cycle begins. The minimum value is the higher of LBCO or 44V. If LBCO is set to greater than Recharge Voltage, this value will change to match the LBCO level.
Absorption Time	C6	30	5 to 480	m	5	Sets the time (in minutes) spent in the Absorption stage before transitioning to the next charge stage.
Default Battery Temperature	C7	uLn	LLd (Cool) uLn (Warm) HDt (Hot)	--	--	Selects the battery temperature charging compensation if a battery temperature sensor (BTS) is not installed. In the absence of a BTS, the charger uses either Cool = 5 °C, Warm = 25 °C, or Hot = 40 °C. Not applicable when LFP battery type is selected.

Invert Sub-settings

Setting Name	Setting Number	Default Value	Range of Values	Unit	Step	Description
Low Battery Cutout (LBCO)	11	44.0	36.0 to 50.0	V	0.1	Controls when the inverter turns off due to a low battery voltage condition. The inverter will turn off only after this level has been reached for the period of time set by the LBCO Delay. This setting is not temperature compensated. NOTE: When battery voltage reaches below this value, the battery must be recharged.
LBCO Hysteresis	12	6.0	0.0 to 10.0	V	0.1	Determines the Low Battery Recovery Voltage Level which is a summation of LBCO + LBCO Hysteresis. The unit will resume operation if the battery voltage exceeds the LBCO Recovery Voltage Level.
LBCO Delay	13	10	0 to 600	s	5	Controls how long the inverter is allowed to operate at or below the LBCO level before turning off due to a low battery voltage condition. When the range is from 1 to 20, the timer setting value can be adjusted by 1-second increments, then by 5-second increments above 20 seconds.

Adjusting Settings in Configuration Mode

Setting Name	Setting Number	Default Value	Range of Values	Unit	Step	Description
Search Threshold	14	50	25 to 255	W	5	Sets the inverter's search sensitivity when Search mode is enabled. When a load larger than this setting is present, the inverter turns on.
Search Delay	15	2	1 to 25	s	1	Sets the time between search pulses. When searching for loads, the Freedom EX 4000 sends out search pulses to determine if a load is present. If the Freedom EX 4000 finds a load above the Search Threshold setting, the inverter turns on.
Power Save	16	dl 5 (disable)	EnR (enable) dl 5 (disable)	--	--	Enables or disables Power save mode. When enabled, the Freedom EX 4000 reduces tare loss from the battery by reducing the inverter output from 120 volts to 108 volts when the loads consume less than 100 watts.

Custom Sub-settings

NOTE: These settings appear only when the battery type is set to *USE* (custom).

Setting Name	Setting Number	Default Value	Range of Values	Unit	Step	Description
Equalization Voltage	U1	64.0	54.0 to 64.0	V	0.1	Sets the equalization voltage.
Absorption Voltage	U2	57.6	40.0 to 65.0	V	0.1	Sets the absorption voltage. Maximum value is 64.0V for custom (USE) battery.
Float Voltage	U3	54.0	40.0 to 64.0	V	0.1	Sets the float voltage.

AC Sub-settings

Setting Name	Setting Number	Default Value	Range of Values	Unit	Step	Description
AC Low Voltage Cutout	R1	80	60 to 115	V	1	Sets the minimum acceptable AC input voltage level.
AC Low Frequency Cutout	R2	55	44 to 59	Hz	1	Sets the minimum acceptable AC input frequency level.
AC High Frequency Cutout	R3	65	61 to 68	Hz	1	Sets the maximum acceptable AC input frequency level.
Generator Support Mode	R4	65E (enable)	65E (enable) 65d (disable)	--	--	Enables or disables Generator support mode.
Generator Support Current	R5	40	0 to 40	A	1	Sets the generator load level at which the inverter supplies power from the batteries to support the generator.

Device Sub-settings

Setting Name	Setting Number	Default Value	Range of Values	Unit	Step	Description
Operating Mode	<i>d1</i>	<i>0PE</i> (operating)	<i>5RF</i> (standby) <i>0PE</i> (operating)	--	--	Sets the operating mode of the system to either Standby or Operating.
Clear Faults and Warnings	<i>d2</i>	<i>d15</i> (disable)	<i>EnR</i> (enable) <i>d15</i> (disable)	--	--	Select <i>EnR</i> to clear the faults and warnings on the unit.
Restore Default Settings	<i>d3</i>	<i>ndF</i>	<i>ndF</i> (current) <i>dEF</i> (default)	--	--	<i>ndF</i> refers to current settings. Select <i>dEF</i> to restore all settings to their default values.
Audible Alarm	<i>d4</i>	<i>b0n</i>	<i>b0n</i> (audible) <i>b0F</i> (mute)	--	--	Sets the alarm sound to audible or mute. When audible, the alarm beeps once every 5 seconds.
Date - Year	<i>d5</i>	<i>00</i>	<i>00 to 99</i>	YY	1	Sets the year of the 21st century. Starts from year 2000 and only displays the last 2 digits "YY" (for example, 22 = 2022)
Date - Month	<i>d6</i>	<i>01</i>	<i>01 to 12</i>	MM	1	Sets the month of the year.
Date - Day	<i>d7</i>	<i>01</i>	<i>01 to 31</i>	DD	1	Sets the day of the month.
Time - Hour	<i>d8</i>	<i>00</i>	<i>00 to 23</i>	HH	1	Sets the hour of the day based on the 24-hour clock. 00 = 24
Time - Minute	<i>d9</i>	<i>00</i>	<i>00 to 59</i>	MM	1	Sets the minute of the hour. 00 = 60



This page is intentionally left blank. [1]

5 ROUTINE MAINTENANCE

Regular maintenance is required to keep your Freedom EX 4000 operating properly. This section includes:

Maintaining the Freedom EX 4000 Unit 44

Maintaining the Freedom EX 4000 Unit

WARNING

ELECTRICAL SHOCK HAZARD

Turning the Power  button to Standby does not disconnect DC battery power from the Freedom EX 4000. You must disconnect from all power sources before working on any circuits connected to the unit.

Failure to follow these instructions can result in death, serious injury, or equipment damage.

Periodically you should:

- With all sources of power off, clean the exterior of the unit with a damp cloth to prevent the accumulation of dust and dirt.
- Ensure that the DC cables are secure and fasteners are tight.
- Make sure the ventilation openings are not clogged.

6 TROUBLESHOOTING

This section will help you narrow down the source of any problem you encounter. Before contacting customer service, please work through the steps listed in *Pre-service Checklist on page 46*. This section includes:

Pre-service Checklist	46
Inverter Applications	47
Resistive Loads	47
Motor Loads	47
Problem Loads	48
Warning Messages	49
Troubleshooting Reference	56

Pre-service Checklist

⚠ WARNING

ELECTRICAL SHOCK HAZARD

Do not disassemble the Freedom EX 4000. It does not contain any user-serviceable parts. Attempting to service the unit yourself could result in an electrical shock or burn.

Failure to follow these instructions can result in death, serious injury, or equipment damage.

NOTE: To obtain service go to *Contact Information on page 1*.

Prior to obtaining service, see below:

1. Check the Alert LED on the LED panel. Observe and record if the light is steady or flashing. If it is flashing, do not operate the unit. Power down all loads and wait for a few minutes or so until the flashing light disappears when the unit is able to recover by itself.
2. As soon as possible, record the conditions at the time the problem occurred so you can provide details when you contact customer service for help. Include the following information:
 - What loads the Freedom EX 4000 was running or attempting to run
 - What the battery condition was at the time (voltage, etc.) if known
 - Recent sequence of events

- Any known unusual AC shore power factors such as low voltage, unstable generator output, etc.
 - Whether any extreme ambient conditions existed at the time (temperature, vibrations, moisture, etc.)
3. When there are no observable flashing LEDs on the LED panel, check the following to make sure the present state of the installation allows proper operation:
 - Is the inverter/charger/converter located in a clean, dry, adequately ventilated place?
 - Are the battery cables adequately sized as recommended in the Installation guide?
 - Is the battery in good condition?
 - Are all DC connections tight?
 - Are the AC input and output connections and wiring in good condition?
 - Are the configuration settings correct for your particular installation?
 - Are all disconnects and AC breakers closed and operable?
 - Have any of the fuses blown in the installation?
 4. Contact customer support for further assistance. Please be prepared to describe details of your system installation and to provide the model and serial number of the unit.

Inverter Applications

The Freedom EX 4000 performs differently depending on the AC loads connected to it. If you are having problems with any of your loads, read this section.

Resistive Loads

These are the loads that the inverter/charger/converter finds the simplest and most efficient to drive. Voltage and current are in phase (that is, in step with one another). Resistive loads usually generate heat in order to accomplish their tasks. Toasters, coffee pots, and heater elements are typical resistive loads. It is usually impractical to run larger resistive loads—such as electric stoves and water heaters—from an inverter due to their high current requirements. Even though the inverter/charger/converter can most likely accommodate the load, the size of battery bank required would be impractical if the load is to be run for long periods.

Motor Loads

Induction motors (that is, motors without brushes) require two to six times their running current on start up. The most demanding are those that start under load, for example, compressors and pumps. Of the capacitor start motors (typical in drill presses, band saws, etc.), the largest you can expect to run is 1.25 hp (the transfer relays are rated at 3 hp). Universal motors are generally easier to start. Since motor characteristics vary, only testing will determine whether a specific load can be started and how long it can be run.

If a motor fails to start within a few seconds or loses power after running for a time, it should be turned off. When the inverter/charger/converter attempts to start a load that is greater than it can handle, it will turn itself off after a few seconds.

Long Transfer Times

The Freedom EX 4000 may take a long time (~ 0.1–0.2 s) to transfer to Battery Mode when shore power is cut off while powering a motor load. Motor loads typically “freewheel” when power is removed (for example, a grinder) and causes a longer transfer time. The longer transition from shore power to inverter power may cause connected computers or other sensitive equipment to operate incorrectly. To avoid this effect, do not connect motor loads together with sensitive equipment to the inverter/charger/converter for power.

Problem Loads

Very Small Loads If the power consumed by a device is less than the 50-watt threshold, the Freedom EX 4000 will not run. When the Freedom EX 4000 is load sensing the output for loads, lights that have a wattage lower than 50-watt threshold, may flash momentarily.

Fluorescent Lights and Power Supplies Some devices cannot be detected when load sensing. Small fluorescent lights are the most common example. Some computers and sophisticated electronics have power supplies that do not present a load until line voltage is available. When this occurs, each unit waits for the other to begin. To drive these loads, either a small companion load like a light bulb rated for more than 50 W must be used to bring the Freedom EX 4000 out of search mode, or the Freedom EX 4000 may be programmed to remain on by disabling search mode.

Clocks You may notice that your clocks are not accurate. Some of the clocks on your appliances may reset when the Freedom EX 4000 is in search mode.

Warning Messages

Warning messages in the form of audible alarms and error codes that appear on the LCD screen to alert you to an impending system change. Warnings do not affect operation.

The error codes are listed in *Table 1*. The text in the **Error Code** column appears on the LCD screen of the display panel.

Warning Messages

Table 7 Event codes displayed on the LCD screen

Event Code	Event Type	Condition	Mode	Action
<p>E - Escalating Auto Fault. See Action for more detail. F - Manual fault. Unit operation stops. See Action to remedy the condition and clear the Alert LED on the unit. See <i>Clear Faults and Warnings on page 41</i>. W - Warning. Unit operation continues. W/F - Unit operation continues with a warning until a manual fault is triggered. See Action to remedy the condition and clear the Alert LED on the unit. See <i>Clear Faults and Warnings on page 41</i>.</p>				
1	E	AC Output Under Voltage	Any mode	Must occur 3 times in 2 minutes before becoming a manual fault. Clear the fault and attempt to restart. Contact customer service if problem persists.
2	E	AC Output Over Voltage	Any mode	Must occur 3 times in 2 minutes before becoming a manual fault. Clear the fault and attempt to restart. Contact customer service if problem persists.
9	F	BMS Node Missing for CVCC mode	Shore (AC) mode	This fault triggers when the charger stage is set to CVCC but there is no BMS node found on the network.
17 and 19	F	Relay(s) Welded	Shore (AC) mode	The AC L1 transfer relay is bad or an AC source was wired directly to the AC output. Disconnect the inverter's output wiring. If error continues, have unit serviced.
18 and 20	F	Relay(s) Welded	Shore (AC) mode	The AC L2 transfer relay is bad or an AC source was wired directly to the AC output. Disconnect the inverter's output wiring. If error continues, have unit serviced.
21	F	Relay(s) Welded	Shore (AC) mode	The AC L1L2 transfer relay is bad or an AC source was wired directly to the AC output. Disconnect the inverter's output wiring. If error continues, have unit serviced.
22	F	Relay(s) Welded	Shore (AC) mode	See 17.

Table 7 Event codes displayed on the LCD screen

Event Code	Event Type	Condition	Mode	Action
<p>E - Escalating Auto Fault. See Action for more detail. F - Manual fault. Unit operation stops. See Action to remedy the condition and clear the Alert LED on the unit. See <i>Clear Faults and Warnings on page 41</i>. W - Warning. Unit operation continues. W/F - Unit operation continues with a warning until a manual fault is triggered. See Action to remedy the condition and clear the Alert LED on the unit. See <i>Clear Faults and Warnings on page 41</i>.</p>				
41	E	Auxiliary Power Supply Under Voltage Shutdown	Any mode	Must occur 3 times in 30 seconds before becoming a manual fault. Clear the fault and attempt restart. If problem persists, call customer service.
42	E	Auxiliary Power Supply Over Voltage Shutdown	Any mode	
44	F	Battery Over Temperature Shutdown	Any mode	Check battery voltage and battery cable connections. Stop charging, if necessary. Check for excessive ambient temperature and adequate ventilation in the battery compartment.
45	F	Capacitor Over Temperature Shutdown	Any mode	Clear the fault and attempt restart. Ensure adequate ventilation. Reduce AC loads.
46	F	Controller Fault	Any mode	Service required.
47	F	DC Under Immediate Voltage Shutdown	Inverter (Battery) mode	Check battery status and recharge if necessary. Check for proper DC cable sizing. Check for loose connections and tighten if necessary.
48	F	DC Under Voltage Shutdown	Inverter (Battery) mode	Check battery status and recharge if necessary. Check for proper DC cable sizing. Check for loose connections and tighten if necessary.
49	F	DC Over Voltage Shutdown	Inverter (Battery) mode	Check for external charging sources, such as a PV charger and an overvoltage alternator. Disconnect, if necessary.

Warning Messages

Table 7 Event codes displayed on the LCD screen

Event Code	Event Type	Condition	Mode	Action
<p>E - Escalating Auto Fault. See Action for more detail. F - Manual fault. Unit operation stops. See Action to remedy the condition and clear the Alert LED on the unit. See <i>Clear Faults and Warnings on page 41</i>. W - Warning. Unit operation continues. W/F - Unit operation continues with a warning until a manual fault is triggered. See Action to remedy the condition and clear the Alert LED on the unit. See <i>Clear Faults and Warnings on page 41</i>.</p>				
51 to 55	F	EEPROM Error	Any mode	No action. Clear fault and resume operating or configuring the unit. If the fault persists, have the unit serviced.
57	F	FET1 Over Temperature Shutdown	Any mode	Reduce the loads connected to the AC outlet of the unit. Check that the ventilation grille is not blocked. Check for ambient temperature and move the unit to a cooler location whenever possible. Check the fan for any obstruction and remove it.
58	F	FET2 Over Temperature Shutdown	Any mode	
59	F	Manual Configuration	Any mode	Auto-configuration process failed. Retry auto-configuration or configure the unit manually.
60	F	Unit Fault	Any mode	Clear faults/warnings and restart. If error persists, contact customer service.
61	F	Unit Fault	Any mode	Clear faults/warnings and restart. If error persists, contact customer service.
62	F	Unit Fault	Any mode	Clear faults/warnings and restart. If error persists, contact customer service.
63	E	AC Overload	Any mode	Must occur 3 times in 5 minutes before becoming a manual fault. Check for loads above the inverter's capacity, turn off some loads if necessary. Power down and restart the unit to clear the manual fault.
64	E	AC Overload Line 1	Any mode	
65	E	AC Overload Line 2	Any mode	

Table 7 Event codes displayed on the LCD screen

Event Code	Event Type	Condition	Mode	Action
<p>E - Escalating Auto Fault. See Action for more detail.</p> <p>F - Manual fault. Unit operation stops. See Action to remedy the condition and clear the Alert LED on the unit. See <i>Clear Faults and Warnings on page 41</i>.</p> <p>W - Warning. Unit operation continues.</p> <p>W/F - Unit operation continues with a warning until a manual fault is triggered. See Action to remedy the condition and clear the Alert LED on the unit. See <i>Clear Faults and Warnings on page 41</i>.</p>				
65	F	System Configuration Fault	Multi-unit configuration settings	Ensure each unit has a unique Device Number, and that associations and physical connections have been configured correctly.
67	F	Watchdog Error	Any mode	Clear faults/warnings and restart. If error persists, contact customer service.
68	W/F	Transformer Over Temperature	Any mode	Reduce the loads connected to the AC outlet of the unit. Check that the ventilation grille is not blocked. Check for ambient temperature and move the unit to a cooler location whenever possible. Check the fan for any obstruction and remove it.
69	F	External Sync Failed	Multi-unit configuration	Check connections and cable on external AC sync port. In a single-inverter system, nothing must be plugged into the AC sync port. Clear fault and try again. If these steps fail, the unit requires service.
71	F	Battery Discharge Over Current	Inverter (Battery) mode	There is an excessive load on the Li-Ion battery. (The fault applies only to Li-Ion batteries.) Change the default threshold of the max battery discharge current limit or reduce the load.
72	F	External AC Contactor Malfunction	Shore (AC) mode	Check why the AC contactor has failed. Check for fusing of coil, wiring and connections. Verify that the AC contactor has power.

Warning Messages

Table 7 Event codes displayed on the LCD screen

Event Code	Event Type	Condition	Mode	Action
<p>E - Escalating Auto Fault. See Action for more detail. F - Manual fault. Unit operation stops. See Action to remedy the condition and clear the Alert LED on the unit. See <i>Clear Faults and Warnings on page 41</i>. W - Warning. Unit operation continues. W/F - Unit operation continues with a warning until a manual fault is triggered. See Action to remedy the condition and clear the Alert LED on the unit. See <i>Clear Faults and Warnings on page 41</i>.</p>				
73	W/F	DC-DC Converter FETA Over Temperature	DC-DC Converter	Reduce the loads connected to the DC load of the unit. Check that the ventilation grille is not blocked. Check for ambient temperature and move the unit to a cooler location whenever possible. Check the fan for any obstruction and remove it.
74	W/F	DC-DC Converter FETB Over Temperature	DC-DC Converter	
75	W/F	DC-DC Converter Under Voltage	DC-DC Converter	Remove the loads connected to the DC-DC converter and try again. Remove the AC loads of the unit.
76	W/F	DC-DC Converter Over Voltage	DC-DC Converter	Check for external charging sources, such as a PV charger or an overvoltage alternator. Disconnect if necessary
77	W/F	DC-DC Converter Over Current	DC-DC Converter	Remove the loads connected to the DC-DC converter and try again. Remove the AC loads of the unit.
78	W/F	Cold Temperature warning and shutdown	Any mode	The unit will generate a warning as its internal temperature approaches the lower range of the Operating Temperature Range. The unit goes into shutdown error and the unit shuts down operation. Increase ambient temperature and once the unit's internal temperature warms up to above freezing and always within the normal Operating Temperature Range, press the Power [Standby] button twice (toggle the switch) on the unit or the remote display panel to restart operation.

Table 7 Event codes displayed on the LCD screen

Event Code	Event Type	Condition	Mode	Action
<p>E - Escalating Auto Fault. See Action for more detail.</p> <p>F - Manual fault. Unit operation stops. See Action to remedy the condition and clear the Alert LED on the unit. See <i>Clear Faults and Warnings on page 41</i>.</p> <p>W - Warning. Unit operation continues.</p> <p>W/F - Unit operation continues with a warning until a manual fault is triggered. See Action to remedy the condition and clear the Alert LED on the unit. See <i>Clear Faults and Warnings on page 41</i>.</p>				
87	W	Fan fatigue warning	Any mode	If there is no issue with the fan/s, disconnect the unit from its DC and AC power sources, then reconnect, and then restart the unit. Perform <i>Step 8: Testing Your Installation</i> . If error detection persists, contact customer service.
88	W	Fan fatigue warning		
89	W	Fan lock warning	Any mode	If there is no issue with the fan/s, disconnect the unit from its DC and AC power sources, then reconnect, and then restart the unit. Perform <i>Step 8: Testing Your Installation</i> . If error detection persists, contact customer service.
90	W	Fan lock warning		
94	W	Remote Power Off	Any mode	No action required. The unit stops inverting or charging immediately, and shuts down after five seconds. If the unit is configured as a master, it signals other network devices to also shut down.
95	W	Equalization Abort	Shore (AC) mode	Equalization terminated abnormally because of interrupted AC input. Wait until AC input returns to in-tolerance condition.
96	W	Cannot Equalize	Shore (AC) mode	Change battery type if your batteries should be equalized. Gel or AGM batteries should not be equalized. AC input is not qualified or the charge setting is not adequate.
97	W	Battery Temperature Sensor Shorted	Any mode	Replace battery temperature sensor.

Troubleshooting Reference

⚠ WARNING

ELECTRICAL SHOCK HAZARD

Do not disassemble the Freedom EX 4000. It does not contain any user-serviceable parts. Attempting to service the unit yourself could result in an electrical shock or burn.

Failure to follow these instructions can result in death, serious injury, or equipment damage.

NOTICE

INVERTER/CHARGER/CONVERTER DAMAGE

Avoid continually overloading the inverter/charger/converter and subjecting it to over temperature conditions. Although provided with integral protection against overloads continual overloading can damage the circuitry.

Failure to follow these instructions can result in damage to the inverter/charger/converter.

Table 8 Troubleshooting reference

Problem	Possible Cause	Solution
Alarm on the Freedom EX Remote Panel (PN: 808-0817-03) does not sound when an error is encountered.	Alarm buzzer is turned OFF.	See <i>Device Sub-settings on page 41</i> and follow instructions to turn the alarm buzzer on again.
No output voltage. The status LED is red.	AC shore power is not available or out of operating range and the inverter/charger/converter has shut down with the LCD screen showing one of the following error codes:	
	High input voltage (error code <i>E02</i>)	Verify the unit is connected to a 48V battery. Check the voltage regulation of the external charging system (if any).
	Unit overload or AC output short circuit (error code <i>E03</i>)	Reduce the load. Make sure the load does not exceed the output rating.
	Thermal shutdown (error code <i>E04</i>)	Allow the unit to cool off. Reduce the load if continuous operation is required. Improve ventilation. Make sure the inverter/charger/converter's ventilation openings are not blocked.

Troubleshooting Reference

Problem	Possible Cause	Solution
No output voltage is shown in the LCD screen but the green status LED for Battery mode is illuminated.	Circuit breaker on the AC load panel or AC output disconnect has tripped.	Reset the circuit breaker or check the AC output disconnect circuits.
	Battery voltage is too low (depending on setting, see <i>Maintaining the Freedom EX 4000 Unit on page 44</i>) to start inverting. LCD screen may show DC voltage as 000.	Check DC connections and cable. Recharge battery.
No output voltage is shown in the LCD screen and neither of the green status LEDs (for Shore mode and Battery mode) is illuminated.	AC shore power is not available or out of operating range and the inverter/charger/converter is OFF.	Check AC shore power. Turn the inverter/charger/converter ON.
	AC shore power is not available and the inverter/charger/converter is OFF due to a shutdown for more than 30 seconds.	Check AC shore power and battery voltage. Turn the inverter/charger/converter ON and look at the LCD screen for any error code. See " <i>Problem</i> " on the previous page.
The fan turns on and off during AC shore power mode.	The battery is discharged. AC pass-through current is high.	Do not be alarmed, the unit is performing normally.
The fan turns on and off during inverter mode.	The inverter is running continuously at high power.	Do not be alarmed, the unit is performing normally. The fan is activated automatically.

7 SPECIFICATIONS

This section summarizes the operational and system specifications of the Freedom EX 4000 Inverter/Charger with 48VDC-to-12VDC Converter. This section includes:

Environmental Specifications	60
System Specifications	60
Regulatory Approvals	64

NOTE: Specifications are subject to change without prior notice. For a complete list of hardware, hardware accessories, and regulatory specifications refer to *Freedom EX Installation Guide* (document number: 975-0998-01-01).

DISCLAIMER REGARDING STATUS DATA

STATUS DATA REPORTED BY THE FREEDOM EX 4000 INVERTER/CHARGER WITH 48VDC-TO-12VDC CONVERTER ARE APPROXIMATE VALUES INTENDED TO PROVIDE GENERAL AND NON-EXACT INFORMATION ABOUT THE FREEDOM EX 4000 INVERTER/CHARGER WITH 48VDC-TO-12VDC CONVERTER. UNDER NO CIRCUMSTANCES SHOULD THIS STATUS DATA BE USED FOR PRECISE EVALUATION OF THE FREEDOM EX 4000 SYSTEM PERFORMANCE, INCLUDING EFFICIENCY CONSIDERATIONS. IN SYSTEMS WITH A SINGLE FREEDOM EX 4000, THE MEASUREMENT CAPABILITIES OF THE INVERTER/CHARGER/CONVERTER ALLOW FOR DEVIATIONS OF UP TO 5% OF ACTUAL VALUES. FOR SYSTEMS REQUIRING HIGHER ACCURACY STATUS REPORTING OF AC PARAMETERS, XANTREX LLC RECOMMENDS THE USE OF EXTERNAL MONITORING EQUIPMENT OF APPROPRIATE AND ACCURATE CALIBRATION. FOR HIGHER ACCURACY MEASUREMENT OF DC (BATTERY) PARAMETERS, XANTREX LLC RECOMMENDS INSTALLING AN APPROPRIATE DC BATTERY MONITOR IN THE SYSTEM.

Environmental Specifications

Table 9 Environmental specifications

	Freedom EX 4000
Rated Temperature Range	0–40 °C (32 –104 °F)
Operating Temperature Range ^a	-10 –60 °C (14 –140 °F), with output derated above 40 °C (104 °F)
Storage Temperature Range	-40 –70 °C (-40 –158 °F)
Humidity: Operation/Storage	5–95% RH, non- condensing
Ingress Protection Rating	IP20

^aOperation may be limited based on the battery chemistry. For example, Lithium Iron Phosphate batteries have a limited charging temperature range. Follow specific battery manufacturer recommendations for the applicable chemistry.

System Specifications

Table 10 System specifications

	Freedom EX 4000
Transfer relay rating (A ^a)	40A (continuous) 50A (max)
Transfer time (milliseconds)	
Shore to inverter: Inverter to shore:	<10 milliseconds <10 milliseconds with a 20-second delay
Transfer voltage (V)	
Shore to inverter: Inverter to shore:	Shore voltage less than 60V(min) - 80V(default) - 115V (max) Shore voltage greater than above value + 2V hysteresis

^aCircuit breakers shall not carry more than 80% of their UL current rating continuously.

Freedom EX 4000	
Shore to inverter: Inverter to shore:	Shore voltage greater than 125V(min) - 138V (default) - 144V(max) Shore voltage less than above value – 2V hysteresis
Waveform	True Sine Wave
Peak Efficiency	95.5 %
Idle consumption (DC-DC converter has no load. Remote display, RV-C control, and BTS are connected.)	< 0.3 W (Power button on unit is Off (Standby)) < 8 W (Power button on unit is On, inverter mode disabled, charger mode enabled) < 30 W (Power button on unit is On, inverter and charger mode enabled)
Cooling	Fan, activated by any of the following: <ul style="list-style-type: none"> ■ High internal temperature ■ High AC output power

Table 11 DC input for inverting

Freedom EX 4000	
Nominal voltage	48 VDC
Operating voltage	40–64 VDC
Maximum current at full load	130 ADC

Table 12 DC output for charging

Freedom EX 4000	
Nominal voltage	48 VDC
Maximum voltage	64 VDC
Maximum charge rate	80 A single unit 160 A when parallel or series stacked ^b
Power factor corrected charging	PF (0.98)

^b Contact Xantrex prior to stacking two Freedom EX 4000 units together. Stacking configuration via USB is a required step to enable stacking.

Environmental Specifications

Table 13 DC output for 12 VDC load

	Freedom EX 4000
Nominal output voltage	13.5 VDC
Maximum output current	45A (continuous @ 25 °C ambient)
	50A (15 minutes @ 25 °C ambient)
	70A (6 minutes @ 25 °C ambient)

Table 14 AC output for inverting

	Freedom EX 4000
Output voltage options	105 to 130 VAC
Continuous power (W ^c)	4000 W @ 40 °C with output derated above 104 °F (40 °C)
Continuous current	33.3 A
Surge power (5 sec)	8000 W
Output Frequency	60 Hz
GFCI protection ^d	customer-provided
Wave shape	True Sine Wave
Total Harmonic Distortion	< 5% at rated power

^c Power derates to 85% when output voltage is set to 110/108 VAC.

^d See *Ground Fault Circuit Interrupters (GFCIs)* for approved device/s.

Table 15 AC output for series-stacked^e pair inverters

	Freedom EX 4000
Output voltage options	210 to 260 VAC
Continuous current	33.3 A
Surge power (5 sec)	16000 W
Output Frequency	60 Hz

Table 16 AC output for parallel-stacked^f pair inverters

	Freedom EX 4000
Output voltage options	105 to 130 VAC
Continuous current	66.6 A
Surge power (5 sec)	16000 W
Output Frequency	60 Hz

^e Contact Xantrex prior to stacking two Freedom EX 4000 units together. Stacking configuration via USB is a required step to enable stacking.
^f Contact Xantrex prior to stacking two Freedom EX 4000 units together. Stacking configuration via USB is a required step to enable stacking.

Table 17 AC input for charging and pass-through

	Freedom EX 4000
Input voltage single-phase (L1-N and L2-N)	80–138 VAC [(120 V nominal), default range] 60–155 VAC [(120 V nominal), allowable range]
Input voltage split-phase ^g (L1-L2)	160–276 VAC
Input breaker	50A, double-pole
Input frequency range	54.5–65 Hz (default) 44–68 Hz (allowable)
Peak efficiency	91%
Full load efficiency	≥ 86%

^g L1-N must be within the single-phase qualification voltage range, 80–138 VAC, for split-phase to operate in a split-phase configuration.

Regulatory Approvals

Table 18 Regulatory approvals

	Freedom EX 4000
Safety	CSA Certified to CSA 107.1 UL458 and UL458 Marine Supplement (drip shield with product number 808-9004 required) ABYC E-11, A-31, A-32
EMC	CFR 47, (FCC) Part 15, Subpart B, Class B CAN ICES-3(B)/NMB-3(B)



This page is intentionally left blank. [2]

xantrex[™]

A MISSION CRITICAL ELECTRONICS BRAND

Smart choice for power[™]

975-0999-01-01 Rev C

30948

Printed in: