

Smart choice for power™

**xantrex™**  
A MISSION CRITICAL ELECTRONICS BRAND

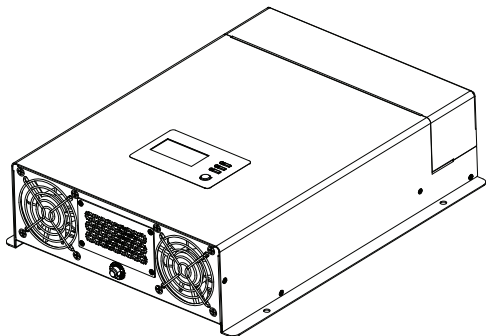

## Owner's Guide

# Freedom X Inverter

FreedomX1000 120VAC 12VDC **817-1000**

FreedomX2000 120VAC 12VDC **817-2000**

FreedomX3000 120VAC 12VDC **817-3000**

FreedomX2000 120VAC 24VDC **817-2000-21**

---

Copyright © 2019 Xantrex LLC. All Rights Reserved.  
All trademarks are owned by Xantrex LLC and its affiliates.

### **Exclusion for Documentation**

UNLESS SPECIFICALLY AGREED TO IN WRITING, SELLER

(A) MAKES NO WARRANTY AS TO THE ACCURACY, SUFFICIENCY OR SUITABILITY OF ANY TECHNICAL OR OTHER INFORMATION PROVIDED IN ITS MANUALS OR OTHER DOCUMENTATION;

(B) ASSUMES NO RESPONSIBILITY OR LIABILITY FOR LOSSES, DAMAGES, COSTS OR EXPENSES, WHETHER SPECIAL, DIRECT, INDIRECT, CONSEQUENTIAL OR INCIDENTAL, WHICH MIGHT ARISE OUT OF THE USE OF SUCH INFORMATION. THE USE OF ANY SUCH INFORMATION WILL BE ENTIRELY AT THE USER'S RISK; AND

(C) REMINDS YOU THAT IF THIS MANUAL IS IN ANY LANGUAGE OTHER THAN ENGLISH, ALTHOUGH STEPS HAVE BEEN TAKEN TO MAINTAIN THE ACCURACY OF THE TRANSLATION, THE ACCURACY CANNOT BE GUARANTEED. APPROVED CONTENT IS CONTAINED WITH THE ENGLISH LANGUAGE VERSION WHICH IS POSTED AT <http://www.xantrex.com/>.

**Document Number:** 975-0787-01-01      Rev F

**Date:** June 2019

### **Product Names and Part Numbers for the 12VDC Models**

Freedom X 1000 120VAC 12VDC (817-1000)

Freedom X 2000 120VAC 12VDC (817-2000)

Freedom X 3000 120VAC 12VDC (817-3000)

### **Product Name and Part Number for the 24VDC Model**

Freedom X 2000 120VAC 24VDC (817-2000-21)

### **Contact Information**

**Telephone:** (Toll Free USA/Canada) +1 800 670 0707 / (Outside USA/Canada) +1 408 987 6030

**Email:** [customerservice@xantrex.com](mailto:customerservice@xantrex.com),  
<http://www.xantrex.com/power-products-support/>

**Web:** <http://www.xantrex.com/>

---

## Information About Your System

As soon as you open your product, record the following information and be sure to keep your proof of purchase.

Serial Number \_\_\_\_\_  
Product Number \_\_\_\_\_  
Purchased From \_\_\_\_\_  
Purchase Date \_\_\_\_\_

To view, download, or print the latest revision, visit the website shown under **Contact Information**.

## Purpose

The purpose of this Owner's Guide is to provide explanations and procedures for installing, operating, configuring, maintaining, and troubleshooting a Freedom X Inverter for Recreational, Commercial and Fleet Vehicle, or Marine installations.

## Scope

The guide provides safety and operating guidelines as well as information on installing and configuring the inverter. It also provides information about troubleshooting the unit. It does not provide details about particular brands of batteries. You need to consult individual battery manufacturers for this information.

## Audience

The guide is intended for users and operators of the Freedom X Inverter. The Installation section starting *on page 15* is intended for qualified personnel.

Qualified personnel have training, knowledge, and experience in:

- Installing electrical equipment.
- Applying all applicable installation codes.
- Analyzing and reducing the hazards involved in performing electrical work.
- Selecting and using Personal Protective Equipment (PPE).

## Abbreviations and Acronyms

A	Amps
---	------

AC	Alternating Current
ACC	Accessory in vehicle ignition system
AGM	Absorbed Glass Mat (a battery type)
DC	Direct Current
in-lb	inch-pound force (a unit of torque)
kW	Kilowatts (1000 watts)
LBCO	Low Battery Cutout (or Cutoff)
LCD	Liquid Crystal Display
LED	Light Emitting Diode
LFP	LiFePO <sub>4</sub> (lithium iron phosphate – a battery type)
N-m	Newton-meters (a unit of torque)
PN	Product Number
PPE	Personal Protective Equipment
PV	Photovoltaic (Solar)
V	Volts
VAC	Volts AC
VDC	Volts DC
W	Watts

## Related Information

You can find more information about Xantrex products and services at <http://www.xantrex.com/>.

# IMPORTANT SAFETY INSTRUCTIONS

READ AND SAVE THIS OWNER'S GUIDE FOR FUTURE REFERENCE.

This guide contains important safety instructions for the Freedom X that must be followed during installation, operation, maintenance, and troubleshooting.

Read these instructions carefully and look at the equipment to become familiar with the device before installing, operating, configuring, maintaining, and troubleshooting it. The following special messages may appear throughout this documentation or on the equipment to warn of potential hazards or to call attention to information that clarifies or simplifies a procedure.



The addition of either symbol to a “Danger” or “Warning” safety label indicates that an electrical hazard exists which will result in personal injury if the instructions are not followed.



This is the safety alert symbol. It is used to alert you to potential personal injury hazards. Obey all safety messages that follow this symbol to avoid possible injury or death.

## **DANGER**

**DANGER** indicates a hazardous situation which, if not avoided, **will result in** death or serious injury.

## **WARNING**

**WARNING** indicates a hazardous situation which, if not avoided, **could result in** death or serious injury.

## **CAUTION**

**CAUTION** indicates a hazardous situation which, if not avoided, **could result in** minor or moderate injury.

## **NOTICE**

**NOTICE** is used to address practices not related to physical injury.

## Product Safety Information

1. Before using the inverter, read all instructions and cautionary markings on the unit, the batteries, and all appropriate sections of this guide.
2. Use of accessories not recommended or sold by the manufacturer may result in a risk of fire, electric shock, or injury to persons.
3. The inverter is designed to be connected to both DC and AC electrical systems. The manufacturer recommends that all wiring be done by a certified technician or electrician to ensure adherence to the local and national electrical codes applicable in your jurisdiction.
4. To avoid a risk of fire and electric shock, make sure that existing wiring is in good condition and that wire is not undersized. Do not operate the inverter with damaged or substandard wiring.
5. Do not operate the inverter if it has been damaged in any way.
6. This unit does not have any user-serviceable parts. Do not disassemble the inverter except where noted for connecting wiring and cabling. See your warranty for instructions on obtaining service. Attempting to service the unit yourself may result in a risk of electrical shock or fire. Internal capacitors remain charged after all power is disconnected.
7. To reduce the risk of electrical shock, disconnect both AC and DC power from the inverter before attempting any maintenance or cleaning or working on any components connected to the inverter. Do not disconnect under load.
8. The inverter must be provided with an equipment-grounding conductor connected to the AC input ground.
9. Do not expose this unit to rain, snow, or liquids of any type. This product is designed for dry-locations-use only. Damp environments will significantly shorten the life of this product and corrosion caused by dampness will not be covered by the product warranty.
10. To reduce the chance of short-circuits, always use insulated tools when installing or working with this equipment.
11. Remove personal metal items such as rings, bracelets, necklaces, and watches when working with electrical equipment.
12. This unit is an inverter only and is not intended for charging batteries.
13. For marine applications, this unit must be installed with a drip shield. Refer to *Marine Installation on page 41* for details.

**⚠ DANGER****ELECTRICAL SHOCK AND FIRE HAZARD**

Installation must be done by qualified personnel to ensure compliance with all applicable installation and electrical codes and regulations. Instructions for installing the Freedom X Inverter are provided here for use by qualified personnel only.

**Failure to follow these instructions will result in death or serious injury.**

**⚠ DANGER****HAZARD OF ELECTRIC SHOCK, EXPLOSION, BURN, OR ARC FLASH**

- Apply appropriate personal protective equipment (PPE) and follow safe electrical work practices. See NFPA 70E or CSA Z462.
- This equipment must only be installed and serviced by qualified electrical personnel.
- Never operate energized with the wiring compartment cover removed.
- Energized from multiple sources. Before removing the wiring compartment cover - identify all sources, de-energize, and wait 2 minutes for circuits to discharge.
- Always use a properly rated voltage sensing device to confirm all circuits are de-energized.
- Replace all devices, doors, and covers before turning on power to this equipment.

**Failure to follow these instructions will result in death or serious injury.**

## **WARNING**

### **ELECTRICAL SHOCK HAZARD**

- Replace the wiring compartment cover before turning on power to this equipment.
- Use a torque screwdriver to tighten the captive nut panel screw to 5 in-lb torque to ensure a proper ground connection and a required tool access to the wiring compartment.

**Failure to follow these instructions can result in death, serious injury, or equipment damage.**

## **WARNING**

### **FIRE AND EXPLOSION HAZARD**

- Unit's components may produce arcs or sparks.
- Do not install near batteries, in machinery space, or in an area in which ignition-protected equipment is required.

**Failure to follow these instructions can result in death, serious injury, or equipment damage.**

Areas include any space containing gasoline-powered machinery, fuel tanks, as well as joints, fittings, or other connections between components of the fuel system.

## **CAUTION**

### **ELECTRICAL SHOCK AND FIRE HAZARD**

- Do not open. No serviceable parts inside. Provided with integral protection against overloads. Bonding between conduit connections is not automatic and must be provided as part of the installation.
- Read guide before installing or using.
- Do not cover or obstruct ventilation openings.
- Do not mount in zero-clearance compartment – overheating may result.
- Do not expose to rain or spray. This inverter is designed for marine applications only when additional drip protection is installed in certain orientations. See “Approved Mounting Orientations” on the Installation Guide for more information.
- Install GFCIs only as specified in this guide. Other types may fail to operate.
- Do not connect AC OUT to any other source of power. Damage to unit may occur.
- For AC IN and AC OUT, use wires suitable for at least 75°C.

**Failure to follow these instructions can result in injury or equipment damage.**



**NOTES:**

- Follow these instructions and those published by the battery manufacturer and the manufacturer of any equipment you intend to use in the vicinity of the battery. Review cautionary markings on these products and on the engine.
- Freedom X Inverter products are designed for deep cycle lead-acid batteries. See warning below when connecting to lithium ion batteries.
- Do not use transformerless battery chargers in conjunction with the inverter due to overheating.

** CAUTION****LITHIUM ION BATTERY TYPE HAZARD**

Make sure to use a lithium ion battery pack that includes a certified Battery Management System (BMS) with built-in safety protocols. Follow the instructions published by the battery manufacturer.

**Failure to follow these instructions can result in serious injury or equipment damage.**

** CAUTION****PHYSICAL INJURY HAZARD**

This Freedom X Inverter is not intended for use by persons (including children) with reduced physical, sensory, or mental capabilities or lack of experience and knowledge, unless they have been given supervision or instruction concerning use of the appliance by a person responsible for their safety. Children should be supervised to ensure that they do not play with the appliance.

**Failure to follow these instructions can result in injury or equipment damage.**

# Precautions When Working With Batteries

**IMPORTANT:** Battery work and maintenance must be done by qualified personnel knowledgeable about batteries to ensure compliance with battery handling and maintenance safety precautions.

## **WARNING**

### **BURN FROM HIGH SHORT-CIRCUIT CURRENT, FIRE AND EXPLOSION FROM VENTED GASES HAZARDS**

- Always wear proper, non-absorbent gloves, complete eye protection, and clothing protection. Avoid touching your eyes and wiping your forehead while working near batteries. See note #4.
- Remove all personal metal items, like rings, bracelets, and watches when working with batteries. See notes #5 and #6 below.
- Never smoke or allow a spark or flame near the engine or batteries.
- Never charge a frozen battery.

**Failure to follow these instructions can result in death, serious injury, or equipment damage.**

## **NOTES:**

1. Mount and place the Freedom X Inverter unit away from batteries in a well ventilated compartment.
2. Always have someone within range of your voice or close enough to come to your aid when you work near a lead-acid battery.
3. Always have plenty of fresh water and soap nearby in case battery acid contacts skin, clothing, or eyes.
4. Keep battery terminals clean from corrosion. If battery acid or corrosion deposit contacts skin or clothing, wash immediately with soap and water. If battery acid or corrosion deposit enters your eye, immediately flood it with running cold water for at least twenty minutes and have someone within range of your voice or close enough to get medical attention immediately.
5. Use extra caution to reduce the risk of dropping a metal tool on the battery. It could spark or short circuit the battery or other electrical parts and could cause an explosion. Use tools with insulated handles only.
6. Batteries can produce a short circuit current high enough to weld a ring or metal bracelet or the like to the battery terminal, causing a severe burn.
7. When removing a battery, always remove the negative terminal from the battery first for systems with grounded negative. If it is grounded positive, remove the positive terminal first. Make sure all loads connected to the battery and all accessories are off so you don't cause an arc.

# Precautions When Placing the Inverter

## WARNING

### FIRE HAZARD

- Do not install the inverter or any part of its supplied wiring in engine compartments.
- For marine installation, always locate the inverter away from the battery and mounted separately in a well-ventilated compartment with adequate space.

**Failure to follow these instructions can result in death, serious injury, or equipment damage.**

## CAUTION

### BURN HAZARD

Avoid touching the external surfaces - heatsink may be hot.  
**Failure to follow these instructions can result in injury or equipment damage.**

## NOTICE

### RISK OF INVERTER DAMAGE

- Never allow battery acid to drip on the inverter when reading gravity, or filling battery.
- Never place the Freedom X unit directly above batteries; gases from a battery will corrode and damage the inverter.
- Do not place a battery on top of the inverter.

**Failure to follow these instructions can result in equipment damage.**

## Regulatory

The Freedom X inverter is certified to appropriate US and Canadian standards. For more information see *Regulatory approvals on page 83*.

The Freedom X inverter is intended to be used for mobile or commercial applications. This inverter is designed for marine applications only when additional drip protection is installed in certain orientations. See the section on Specifications for information.

## FCC Information to the User

This equipment has been tested and found to comply with the limits for a Class B digital device, pursuant to part 15 of the FCC Rules. These limits are designed to provide reasonable protection against harmful interference in a residential installation. This equipment generates, uses, and can radiate radio frequency energy and, if not installed and used in accordance with the instructions, may cause harmful interference to radio communications.

However, there is no guarantee that interference will not occur in a particular installation. If this equipment does cause harmful interference to radio or television reception, which can be determined by turning the equipment off and on, the user is encouraged to try to correct the interference by one or more of the following measures:

- Reorient or relocate the receiving antenna.
- Increase the separation between the equipment and receiver.
- Connect the equipment into an outlet on a circuit different from that to which the receiver is connected.
- Consult the dealer or an experienced radio/TV technician for help.

### CAUTION

Unauthorized changes or modifications to the equipment could void the user's authority to operate the equipment.

## End of Life Disposal

The Freedom X Inverter is designed with environmental awareness and sustainability in mind. At the end of its useful life, the Freedom X can be decommissioned and disassembled.

Components which can be recycled must be recycled and those that cannot be recycled must be disposed of according to local, regional, or national environmental regulations.

Many of the electrical components used in the Freedom X Inverter are made of recyclable material like steel, copper, aluminum, and other alloys. These materials can be auctioned off to traditional scrap metal recycling companies who resell reusable scraps.

Electronic equipment such as the circuit boards, connectors, and fuses can be broken down and recycled by specialized recycling companies whose goal is to avoid having these components end up in the landfill.

For more information on disposal, contact Xantrex.

# CONTENTS

Important Safety Instructions .....	v	Features .....	5
Product Safety Information .....	vi	Default Settings .....	6
Precautions When Working With Batteries .....	x	AC/DC and GFCI Panel .....	8
Precautions When Placing the inverter .....	xi	Display Panel .....	10
Regulatory .....	xi	Side Panel .....	11
FCC Information to the User .....	xii	Installation .....	13
End of Life Disposal .....	xii	Before You Begin the Installation .....	14
Contents .....	xiii	Installation Codes .....	15
Introduction .....	1	Installation Tools and Materials .....	15
Materials List .....	2	Basic Installation Procedures .....	16
Key Features .....	2	Step 1: Designing the Installation .....	17
Power for Most Appliances .....	2	Step 2: Choosing a Location for the Unit .....	23
Back-up Capability .....	2	Step 3: Mounting the Unit .....	24
Configurable AC Transfer Speed .....	3	Step 4: Connecting the AC Input Wires .....	26
Overload Alarm and Shutdown .....	3	Step 5: Connecting AC Output to an Existing AC Circuit .....	31
Over temperature Alarm and Shutdown .....	3	Step 6: Connecting the DC Cables .....	33
Ignition Control .....	3	Step 7: Connecting to Port(s) on the Freedom X .....	39
Configurable AC Output Frequency and Voltage .....	4	Step 8: Testing Your Installation .....	39

Marine Installation .....	41	Transitioning from Grid Mode to Battery Mode .....	59
Drip Shield Installation .....	42	Transitioning from Battery Mode to Grid Mode .....	60
<b>Operation .....</b>	<b>43</b>	Operating Limits .....	61
Freedom X Display Panel .....	44	Power Output .....	61
Status LED Indicators .....	44	Input Voltage .....	62
Function Buttons .....	45	Overload Conditions .....	63
LCD Screen .....	45	High Surge Loads .....	63
LCD Screen Icons .....	46	Over-temperature Conditions .....	64
Viewing Information During Battery Mode .....	47	<b>Routine Maintenance .....</b>	<b>65</b>
Viewing Information During Grid Mode .....	49	Freedom X Unit .....	66
Adjusting Feature Settings in Configuration Mode .....	51	<b>Troubleshooting .....</b>	<b>67</b>
Settings .....	52	Pre-service Checklist .....	68
Operating in Battery Mode .....	56	Warning Messages .....	69
Turning Inverter Operation ON and OFF .....	56	Troubleshooting Reference .....	72
Power Save Timer .....	57	Inverter Applications .....	76
Power Save Mode .....	57	Resistive Loads .....	76
Checking Battery Status .....	58	Motor Loads .....	76
Checking Output Power .....	58	<b>Specifications .....</b>	<b>77</b>
Operating Several Loads at Once .....	58	Physical Specifications .....	78
Turning the Audible Alarm ON or OFF .....	58	Environmental Specifications .....	79
Operating During Transition Between Grid Mode and Battery Mode .....	59	System Specifications .....	80
		Regulatory Approvals .....	83

# 1 INTRODUCTION

The Freedom X Inverter is designed with integrated inverting functions and power management features suitable for marine, recreational, and commercial/fleet vehicle installations.

Please read this section to familiarize yourself with the main performance and protection features of the Freedom X.

This section includes:

<b>Materials List</b> .....	<b>2</b>
<b>Key Features</b> .....	<b>2</b>
Power for Most Appliances .....	2
Back-up Capability .....	2
Configurable AC Transfer Speed .....	3
Overload Alarm and Shutdown .....	3
Over temperature Alarm and Shutdown .....	3
Ignition Control .....	3
Configurable AC Output Frequency and Voltage .....	4

## Materials List

The Freedom X base package includes the following items:

- one Freedom X unit
- one Owner's Guide and extra safety labels
- one pre-installed DC ground enclosure lug (not shown)
- one set of plastic bushings for large DC cables<sup>a</sup> (not shown)
- two AC knockout hole plugs<sup>b</sup> (not shown)

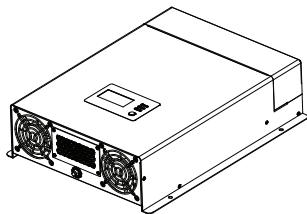

Figure 1 What's In The Box

**NOTE:** If any of the items are missing, contact Xantrex or any authorized Xantrex dealer for replacement. See *Contact Information on page ii*.

<sup>a</sup>Available only to the Freedom X 2000 120VAC 12VDC only.

<sup>b</sup>Available only to the Freedom X 3000 120VAC 12VDC only.

## Key Features

### Power for Most Appliances

The Freedom X inverter provides up to 1000 watts (Freedom X 1000 120VAC 12VDC) or 2000 watts (Freedom X 2000 120VAC 12VDC or 24VDC) or 3000 watts (Freedom X 3000 120VAC 12VDC) of continuous utility grade, sine wave power derived from a battery bank. It is designed to handle loads such as microwave ovens, TVs, DVD/Blu-ray players, and power tools. In addition, the Freedom X's high-surge capability lets you handle many hard-to-start loads, including full size residential refrigerators.

The built-in transfer switch automatically transfers between inverter power and shore power from recreational facilities such as boat docks or campsites to ensure power is always available.

### Back-up Capability

If incoming shore power is interrupted by external events like brownouts, the Freedom X automatically becomes an independent power source<sup>3</sup> that supplies utility grade AC power to your loads.

<sup>3</sup>Assuming the inverter is connected to a battery source with an adequate charge at the time of the power interruption.



## Comprehensive Protection

The Freedom X's built-in protection features safeguard your batteries (from unnecessary drain) such as the low battery voltage alarm and shutdown and protect equipment such as a configurable AC transfer speed.

- **Selectable Low Battery Shutdown:** The low battery shutdown for the inverter can be manually selected by the user from 10.1 to 12.8 VDC (12VDC models) and from 20 to 25.6 VDC (24VDC model).
- **Low Voltage Shutdown Delay Timer:** Configurable from 1 to 300 seconds to reduce an unnecessary shutdown of inverter operation such as during cranking or other brief but heavy discharge of battery.
- **Inverter Power Save:** The Freedom X can be programmed to automatically turn off after 1 to 25 hours of continued operation of loads that are under 50 watts. It is designed, with LBCO (low battery cut off), to prevent the battery from deep discharge.

## Configurable AC Transfer Speed

The Freedom X allows two speed settings for the AC transfer from Grid Mode to Battery Mode and vice versa which avoids nuisance resetting of appliances. The normal transfer rate is for common appliances and the faster transfer rate is designed for more sensitive digital equipment like a desktop computer.

## Overload Alarm and Shutdown

During Battery Mode (also called Inverter Mode), the Freedom X automatically alerts you if the loads that are connected and drawing power from the unit are close to approaching the maximum operating limit. If so, the Freedom X automatically shuts down when the maximum operating limit is exceeded. See *Troubleshooting Reference on page 72* for precautions.

## Over temperature Alarm and Shutdown

During Battery Mode, the Freedom X automatically alerts you if it is overheating and approaching the over-temperature shutdown limit. The Freedom X automatically shuts down when the limit is exceeded. See *Troubleshooting Reference on page 72* for precautions.

## Ignition Control

The Freedom X provides two user-selectable options for ignition control:

- **Ignition Auto-on:** The Freedom X can automatically turn the inverter on and off in tandem with the vehicle's ignition circuit or a manually operated remote switch.
- **Ignition Lockout:** The Freedom X features the ability to inhibit the inverter from operating in the absence of a voltage signal from a vehicle's ignition circuit. This is particularly useful if the inverter is required to operate only when a vehicle's engine is running.

## **Configurable AC Output Frequency and Voltage**

The Freedom X is factory set to 60 Hz AC output frequency and 120 V AC output voltage. It can be configured to 50 Hz for use in regions outside the USA and Canada. The AC voltage setting can also be configured to either of three settings: 108, 110, or 120 volts.

## 2 FEATURES

This section identifies the default settings and the hardware features of the Freedom X Inverter.

This section includes:

<b>Default Settings</b> .....	<b>6</b>
<b>AC/DC and GFCI Panel</b> .....	<b>8</b>
<b>Display Panel</b> .....	<b>10</b>
<b>Side Panel</b> .....	<b>11</b>

## Default Settings

Table 1 lists the default settings for the Freedom X system.

You may record your settings in the right-hand column after you have configured the Freedom X.

*Table 1 Freedom X Default Values*

Program	Item	Default Setting		Setting
01	Inverter ignition control	Off	OFF	
02	Low battery cutoff (LBCO) voltage (12VDC models)	10.5 volts DC	10.5	
	Low battery cutoff (LBCO) voltage (24VDC model)	21.0 volts DC	21.0	
03	LBCO shutdown delay timer	300 seconds	300	
04	LBCO recovery voltage (12VDC models)	13.1 volts DC	13.1	
	LBCO recovery voltage (24VDC model)	26.2 volts DC	26.2	
05	Power save time	25 hours	25	
06	Load sensing	Disabled	d 15	
07	Inverter output frequency	60 Hz	60	
08	Inverter output voltage	120 volts AC	120	

Program	Item	Default Setting		Setting
09	Inverter power limit Freedom X 1000 120VAC 12VDC	1 kW	1	
	Freedom X 2000 120VAC 12VDC/24VDC	2 kW	2	
	Freedom X 3000 120VAC 12VDC	3 kW	3	
10	Inverter power limit timer	300 seconds	300	
11	Transfer mode	Appliance	APL	
12	Utility AC under-voltage level	90 volts AC	90	
13	Inverter fault recovery	Manual	MAN	
14	Audible alarm	On	On	

# AC/DC and GFCI Panel

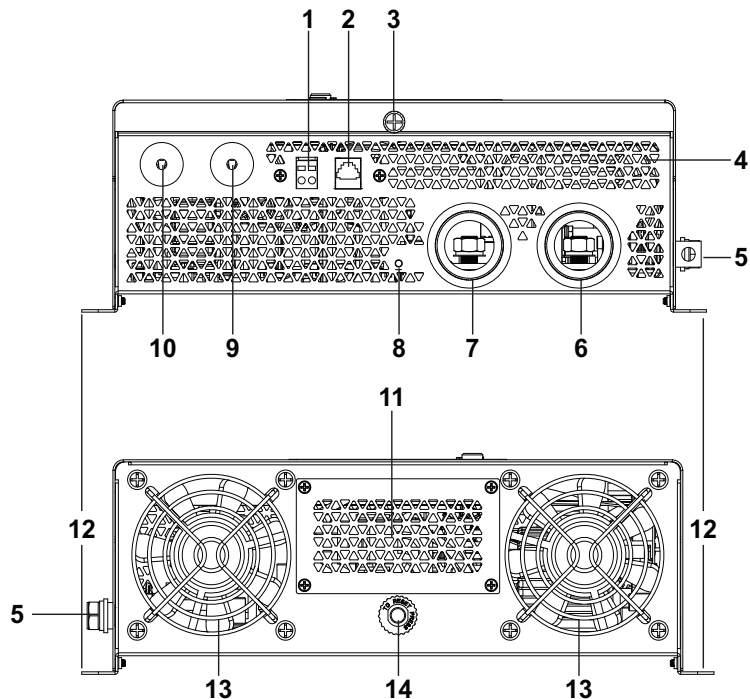

Figure 2 AC/DC and GFCI Panel

## ⚠ WARNING

### ELECTRICAL SHOCK HAZARD

Use a torque screwdriver to tighten the captive nut panel screw to 5 in-lb torque of force to ensure a proper ground connection and a required tool access to the wiring compartment.

**Failure to follow these instructions can result in death, serious injury, or equipment damage.**

Table 2 AC/DC and GFCI Panel Features

Feature	Description
1	<b>ACC input terminal</b> for connecting ignition control wiring. Ignition Control Switch (ACC) for connecting [ON (I)] and disconnecting [OFF (O)] the ignition signal.
2	<b>Remote port</b> allows you to connect an accessory remote control device.
3	<b>Captive nut panel screw</b> holds the wiring compartment cover in place. See WARNING above.
4	<b>Ventilation grille</b> (openings) must not be obstructed.

Feature	Description
5	<b>Grounding lug</b> provides a ground path for the Freedom X chassis to the DC system ground. See WARNING.
6	<b>DC terminal</b> opening for routing (–) negative DC cable.
7	<b>DC terminal</b> opening for routing (+) positive DC cable.
8	<b>LED indicator</b> for reverse DC polarity.
9	<b>AC output terminal opening</b> for routing AC output wiring.
10	<b>AC input terminal opening</b> for routing AC input wiring.
11	<b>GFCI cover</b> is removed when installing a qualified GFCI device such as the optional GFCI kit (sold separately; order PN: 808-9817).
12	<b>Mounting flanges</b> on both sides allow you to mount the inverter permanently on deck or on a wall.

Feature	Description
13	<b>Ventilation grille</b> (openings) must not be obstructed for the proper operation of the cooling fan and inverter. When the inverter is mounted, the ventilation grille must not point up or down. <b>Cooling fans</b> turn on when the internal temperature reaches a set point temperature.
14	<b>20 A supplementary protector with reset button</b> provides overload protection for the Freedom X GFCI Kit (PN: 808-9817) (sold separately) option. Press to recover from an overload condition. In a hard wired installation, the supplementary protector does not protect output wiring.

## WARNING

### ELECTRICAL SHOCK HAZARD

- Use a torque screwdriver to tighten the bolt on the DC ground lug to a torque of 23 in-lb (2.6 N-m) of force.
- Apply an anti-corrosion compound to the copper wire prior to connecting to the DC ground lug.

**Failure to follow these instructions can result in death, serious injury, or equipment damage.**

# Display Panel



Figure 3 Display Panel

Table 3 Display Panel Features

Feature	Description
1	<b>Display panel</b> displays status information on the screen. It is comprised of a display screen, LEDs, select and power buttons.
2	<b>Multi-function LCD screen</b> shows status information and error codes.
3	<b>Status LEDs</b> indicate the mode of operation.
4	Three <b>function buttons</b> change status information displayed on the screen. Also, changes inverter settings.
5	<b>Power button</b> is pressed for turning on the unit. The inverter turns on for the loads automatically.
<b>IMPORTANT:</b> See <i>Freedom X Display Panel</i> on page 44 for detailed information on the panel's buttons.	



# Side Panel

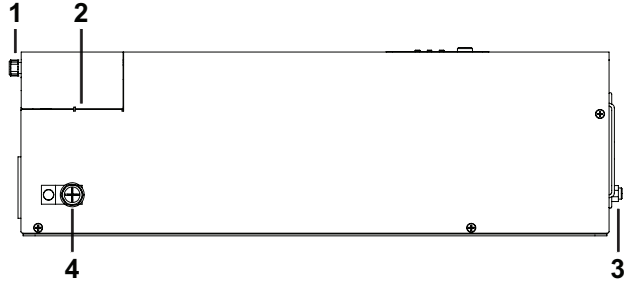

Figure 4 Side Panel

## **⚠ WARNING**

### **ELECTRICAL SHOCK HAZARD**

- Use a torque screwdriver to tighten the captive nut panel screw to 5 in-lb torque to ensure a proper ground connection and a required tool access to the wiring compartment.
- Use a torque screwdriver to tighten the bolt on the DC ground lug to a torque of 23 in-lb (2.6 N-m) of force.
- Apply an anti-corrosion compound to the copper wire prior to connecting to the DC ground lug.

**Failure to follow these instructions can result in death, serious injury, or equipment damage.**

Table 4 Side Panel Features

Feature	Description
1	<b>Captive nut panel screw</b> holds the wiring compartment cover in place. See WARNING above.
2	<b>Wiring compartment cover</b> protects the wiring compartment from debris and keeps the cables secure. Using the captive nut panel screw, the cover can be opened and lifted out during wiring. See WARNING on the left.
3	<b>20 A supplementary protector with reset button</b> provides overload protection for the Freedom X GFCI Kit (PN: 808-9817) (sold separately) option. Press to recover from an overload condition. In a hard wired installation, the supplementary protector does not protect output wiring.
4	<b>Grounding lug</b> provides a ground path for the Freedom X chassis to the DC system ground. See WARNING.

This page is intentionally left blank.

## 3 INSTALLATION

Please read this section for safety information and installation instructions regarding your Freedom X.

This section includes:

<b>Before You Begin the Installation</b> .....	<b>14</b>
<b>Installation Codes</b> .....	<b>15</b>
<b>Installation Tools and Materials</b> .....	<b>15</b>
<b>Basic Installation Procedures</b> .....	<b>16</b>
Step 1: Designing the Installation .....	17
Step 2: Choosing a Location for the Unit .....	23
Step 3: Mounting the Unit .....	24
Step 4: Connecting the AC Input Wires .....	26
Step 5: Connecting AC Output to an Existing AC Circuit .....	31
Step 6: Connecting the DC Cables .....	33
Step 7: Connecting to Port(s) on the Freedom X .....	39
Step 8: Testing Your Installation .....	39
<b>Marine Installation</b> .....	<b>41</b>
Drip Shield Installation .....	42

## Before You Begin the Installation

Before beginning your installation:

- Read this entire Installation section so you can plan the installation from beginning to end.
- Assemble all the tools and materials you require for the installation.
- Review the *Important Safety Instructions on page v*
- Be aware of all safety and electrical codes which must be met.

### **WARNING**

#### **ELECTRICAL SHOCK AND FIRE HAZARD**

- All wiring should be done by qualified personnel to ensure compliance with all applicable installation codes and regulations.
- Do not connect to AC and DC power sources during installation. Disconnect from all power sources when servicing.
- Disable and secure all AC and DC disconnect devices and automatic generator starting devices.
- To prevent risk of fire, do not cover or obstruct ventilation openings. Do not mount in a zero-clearance compartment. Overheating may result.

**Failure to follow these instructions can result in death, serious injury, or equipment damage**

## Installation Codes

Governing installation codes vary depending on the specific location and application of the installation. Some examples include the following:

- The U.S. National Electrical Code (NEC)
- The Canadian Electrical Code (CEC)
- The U.S. Code of Federal Regulations (CFRs)
- Canadian Standards Association/CSA Group (CSA) and the RV Industry Association (RVIA) standards and codes for installations in RVs
- The American Boat and Yacht Council (ABYC) standards and US Coast Guard Regulations (33CFR183, Sub Part I) for Marine installations in the U.S.

It is the installer's responsibility to ensure that all applicable installation requirements are met.

## Installation Tools and Materials

You will need the following to install the Freedom X:

- Wire stripper
- Mounting (#2) screws or bolts
- #2 Phillips torque screwdriver
- 3mm slot long neck screwdriver for spring clamp AC terminals
- Torque wrench for DC terminals (½" or 13mm socket wrench)
- AC cable (that is, two-conductor-plus-ground cable), sized appropriately for load and application
- ½" (or ¾") trade-size strain relief clamps (for the AC cable clamp holes<sup>a</sup>)
- Wire nuts or crimp connectors for AC wire and appropriate tools
- DC cable, sized appropriately for load and application
- Lugs for DC cables to fit <sup>5</sup>/<sub>16</sub>" DC stud terminals as well as appropriate tools (like a crimping tool)
- AC and DC disconnects and over-current protective devices

---

<sup>a</sup>Only the Freedom X 3000 120VAC 12VDC has the 3/4" trade-size knockout hole.

## Basic Installation Procedures

This section provides sample installation information as a guide for your installation. For your convenience, the overall procedure is divided into these main steps:

<b>Step 1: Designing the Installation</b> .....	<b>17</b>
<b>Step 2: Choosing a Location for the Unit</b> .....	<b>23</b>
<b>Step 3: Mounting the Unit</b> .....	<b>24</b>
<b>Step 4: Connecting the AC Input Wires</b> .....	<b>26</b>
<b>Step 5: Connecting AC Output to an Existing AC Circuit</b> ..	<b>31</b>
<b>Step 6: Connecting the DC Cables</b> .....	<b>33</b>
<b>Step 7: Connecting to Port(s) on the Freedom X</b> .....	<b>39</b>
<b>Step 8: Testing Your Installation</b> .....	<b>39</b>

**NOTE:** For marine applications, see additional installation instructions *on page 41*.

## Step 1: Designing the Installation

Most Freedom X installations share common components, and some of these are briefly described in *Step 1: Designing the Installation*.

Figure 5 shows some components and their relationship to each other in a typical recreational vehicle or fleet vehicle installation. Also, see "Marine Installation" on page 41.

1	20-pin harness accessory <b>Not applicable for this product.</b>
2	Equipment ground
3	Freedom X
4	DC fuse/disconnect/DC circuit breaker
5	12V/24V (as applicable) deep cycle battery
6	Battery isolator
7	Alternator
8	To engine
9	Equipment ground
10	Starting battery
11	AC load panel
12	AC source panel
13	Selector switch
14	Shore power
15	Generator

Figure 5 Typical Recreational Vehicle and Fleet Vehicle Installation

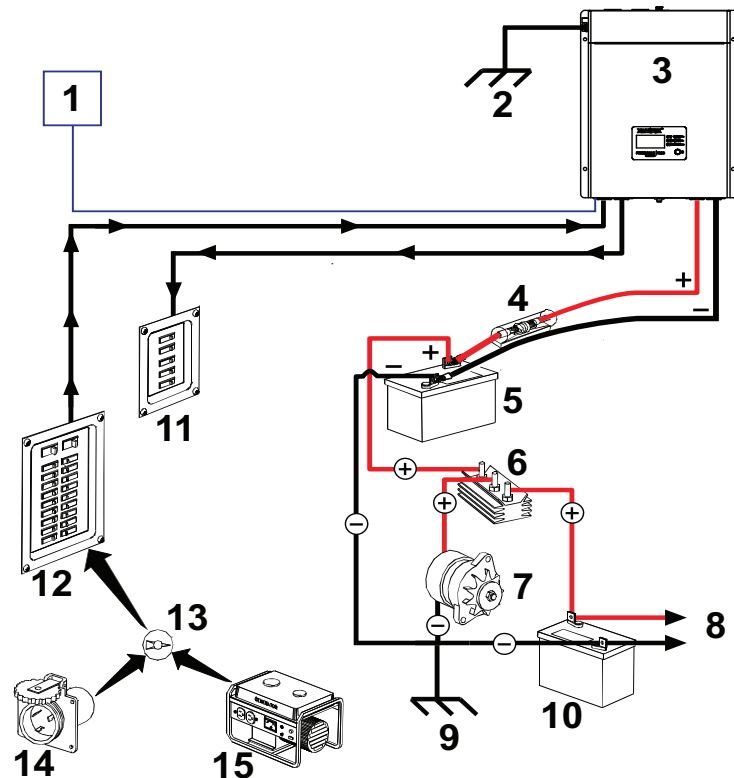

## AC Shore Power

A source of 120 volts AC 60Hz sine wave alternating current provides energy to pass power through to AC loads. This source is usually the utility grid (power company) or an AC generator. An automatic or manual AC source selector switch can be used to switch between the multiple sources of shore power to the Freedom X system.

The AC source feeding the Freedom X must have the neutral conductor bonded to ground. When the inverter passes shore power through, it will lift its internal bonding relay on the output and will rely on the input being bonded in order to ensure that the power delivered to a sub panel is properly bonded. See *AC Shore Power on page 18* for more information on bonding relay operation.

**NOTE:** Throughout this guide, the term “shore power” refers to AC input power from a utility grid, generator, or other AC source.

## AC Disconnect and Over-Current Protection Device

Most safety requirements and electrical codes require the Freedom X's AC and DC inputs and outputs to be provided with over-current protection (such as circuit breakers or fuses) and disconnect devices.

## AC Input

The circuit breaker or fuse (connected through hard wiring) that is used to supply the Freedom X must be rated at no more than 30A and must be approved for use on 120 volts AC branch circuits. The wire used between the breaker and the Freedom X input must be sized adequately to carry current up to the rating of the input breaker and in accordance with the electrical codes or regulations applicable to your installation.

## AC Output

The circuit breaker or fuse must be rated at no more than the rating of the input breaker in the installation and must be approved for use on 120 volts AC branch circuits. The wire used between the Freedom X and the AC output breaker must be of adequate size to match the AC input circuit breaker's rating. The wiring from each AC output breaker to each of the loads must be adequately sized to carry the current rating of the individual AC output breaker.



**Disconnect Devices** Each system requires a method of disconnecting the AC circuits. If the over-current protection devices are circuit breakers, they will also serve as the disconnects. If fuses are used, separate AC disconnect switches will be needed ahead of the fuses. These will have to be a branch circuit rated for 120 volts AC and have an appropriate current rating.

## AC Distribution Panels

Most systems incorporate distribution centers both ahead of the Freedom X (the AC source panel) and between the Freedom X and the loads (the AC load panel). An AC source panel includes a main circuit breaker, which serves as over-current protection and as a disconnect for the AC shore power supply line. Additional circuit breakers serve individual circuits, one of which serves the Freedom X. The AC load panel can incorporate an AC output circuit breaker and breakers for individual load circuits.

### ***NOTICE***

#### **RISK OF INVERTER DAMAGE**

Do not connect the Freedom X to a 120/240V, 3-pole, 4-wire circuit.

**Failure to follow these instructions can result in equipment damage.**

## AC Cabling

AC cabling includes all the wires and connectors between the AC source and the Freedom X, as well as all cabling between the Freedom X and the AC output panels, circuit breakers, and loads. The type and size of the wiring varies with the installation and load. For example, in high vibration environments, such as marine or RV applications, wire nuts may not be acceptable, so crimp splices would be required. In other applications, flexible multiple-strand wire may be required. Installation codes usually specify

solid or stranded, overall size of the conductors, and type and temperature rating of the insulation around the wire.

AC breakers and fuses must be sized to adequately protect the wiring that is installed on the input and output AC circuits of the Freedom X. All breakers and wiring must be sized and connected in accordance with the electrical codes or regulations applicable to your installation. *Table 5* gives some examples of wiring sizes based on the U.S. National Electrical Code and the Canadian Electrical Code. These examples are based on using a two-conductor-plus-ground cable rated at 75 °C, and assuming an ambient temperature of up to 30 °C. Ensure that your breakers and fuses have suitable temperature ratings for your wiring. Other codes and regulations may also be applicable to your installation.

*Table 5 Required AC Wire Size vs Breaker Rating*

<b>Breaker Size (amps)</b>	10A	15A	20A	30A
<b>Minimum Wire Size</b>	14AWG	14AWG	12AWG	10AWG

## AC Output Neutral Bonding

The neutral conductor of the Freedom X's AC output circuit (that is, AC Output Neutral) is automatically connected to the safety ground during inverter operation. When AC utility power is present this connection is not present, so that the utility neutral (that is, AC Input Neutral) is only connected to utility ground at your source. This conforms to the National Electrical Code (NEC), which requires that separately derived AC sources (such as inverters and generators) have their neutral conductors tied to ground in the same way that the neutral conductor from the utility is tied to ground in only one place. Check the regulations for your specific application to ensure that the installation will comply with the necessary requirements. In other words, the AC Input Neutral ground bonding and Output Neutral ground bonding must be isolated from each other.

## AC Grounding

As per UL458 SA29.5, for all permanently connected marine inverters: The Freedom X should be connected to a grounded, metal, permanent wiring system. Also, make sure that an AC ground wire is connected to the AC ground terminal on the unit. Do not just connect the line and neutral wires.

All connections to the unit should comply with all local codes and ordinances.

## DC Cabling

This includes all the cables and connectors between the batteries, the DC disconnect and over-current protection device, and the Freedom X. Most mobile installations require multi-strand insulated cables for flexibility and durability in high vibration environments and require disconnects and over-current devices. Electrical wiring sizes in North America are indicated by AWG notation. In other parts of the world, the metric system is used. Under the AWG standard, a larger gauge number indicates a smaller wire diameter. Wire size is usually marked on the larger sized cables. *Table 6* specifies the minimum recommended DC cable size and maximum fuse size for the Freedom X. **The DC cables must be copper and must be rated 75 °C minimum.** The cables should be terminated with lugs that fit the DC stud terminals snugly (<sup>5</sup>/<sub>16</sub>" hole size).

*Table 6 Required Cable Sizes*

Inverter	Cable Length: Battery to Inverter (one way)	Minimum Cable Size	Maximum battery Fuse Size
Freedom X 1000 120VAC 12VDC	Less than 5 feet (1.5 meters)	No. 2 AWG	150 A DC
Freedom X 2000 120VAC 12VDC		No. 2/0 AWG	250 A DC
Freedom X 3000 120VAC 12VDC		No. 4/0 AWG	350 A DC
Freedom X 2000 120VAC 24VDC	Less than 5 feet (1.5 meters)	No. 2 AWG	150 A DC

**NOTE:** It is not recommended using a cable longer than 5 feet (1.5 meters) in each direction. North American cable sizes above are based on the US National Electrical Code Table 310.17 - 75 °C cables, assuming an ambient temperature of 30 °C cables.

**IMPORTANT:** Using the correct cable size is critical to achieving the rated performance of the Freedom X unit. When starting a heavy load the Freedom X can draw current surges from the battery of up to 400A (in 12VDC models). If the DC wiring is too

small the voltage drop from this surge will result in a voltage at the Freedom X terminals that is too low for the Freedom X to operate correctly. The Freedom X may appear to operate correctly with smaller cables until a heavy load such as a microwave or refrigerator attempts to start - then the unit may work correctly sometimes and not work correctly other times.

### **DC Disconnects and Over-Current Devices**

The DC circuit from the battery to the Freedom X must be equipped with a disconnect and over-current device. This usually consists of a circuit breaker, a “fused-disconnect”, or a separate fuse and DC disconnect. **Do not confuse AC circuit breakers with DC circuit breakers.** They are not interchangeable. The rating of the fuse or breaker must be matched to the size of cables used in accordance with the applicable installation codes. The breaker or disconnect and fuse should be located as close as possible to the battery, in the positive cable. Applicable codes may limit how far the protection can be from the battery.

### **Batteries**

The Freedom X uses 12-volt battery banks typically, or 24-volt battery banks for the 24VDC model. Every Freedom X system is recommended to have a deep-cycle battery or group of batteries with a total capacity of 100 Ah or more which provides the DC current that the Freedom X converts to AC.

### **Ground Fault Circuit Interrupters (GFCIs)**

A GFCI is a device that de-energizes a circuit when a current to ground exceeds a specified value that is less than that required to blow the circuit breaker. GFCIs are intended to protect people from electric shocks and are usually required in wet or damp locations.

Installations in marine and recreational vehicles require GFCI protection of branch circuits connected to the AC output of the Freedom X.

The Freedom X GFCI Kit (PN: 808-9817) (sold separately) option is available to use with the Freedom X inverter unit.

## Step 2: Choosing a Location for the Unit

### WARNING

#### FIRE AND EXPLOSION HAZARDS

- Do not install the Freedom X in compartments containing batteries or flammable materials, or in locations that require ignition-protected equipment. This includes any space containing gasoline-powered machinery, fuel tanks, or joints, fittings, or other connections between components of the fuel system. This equipment contains components that tend to produce arcs or sparks.
- Do not install on or over combustibles surfaces.
- Do not cover or obstruct the ventilation openings.
- Do not install the Freedom X in a zero-clearance compartment. Overheating may result.

**Failure to follow these instructions can result in death, serious injury, or equipment damage.**

The Freedom X should only be installed in locations that meet the following requirements:

- **Dry.** Do not allow water or other fluids to drip or splash on the Freedom X. **Do not mount the Freedom X in an area subject to splashing water or bilge water.**
- **Cool.** Normal air temperature should be between -4 °F and 104 °F (-20 °C and 40 °C)—the cooler the better.

- **Ventilated.** Allow at least 5 inches of clearance at the fan end of the Freedom X for air flow, 1 inch on each side, and 2 inches at the wiring access (AC and DC) end. The more clearance for ventilation around the unit, the better the performance. Do not allow the ventilation openings on the ends of the unit to become obstructed.
- **Safe.** Do not install the Freedom X in the same compartment as batteries or in any compartment capable of storing flammable liquids like gasoline.
- **Close to the battery compartment and the AC source and load panels.** Avoid excessive cable lengths (which reduce input and output power due to wire resistance). Use the recommended cable lengths and sizes, especially between the battery banks and the Freedom X.
- **Protected from battery acid and gases.** Never allow battery acid to drip on the Freedom X or its wiring when reading specific gravity or filling the battery. Also do not mount the unit where it will be exposed to gases produced by the batteries. These gases are very corrosive, and prolonged exposure will damage the Freedom X.

## Step 3: Mounting the Unit

### To mount the Freedom X:

1. Remove the Freedom X from its shipping container, verify that all components are present, and record relevant product information on "Information About Your System" in the Owner's Guide.
2. Select an appropriate mounting location and orientation (see *Figure 6*). To meet regulatory requirements, for use in on-land applications, the Freedom X must be mounted in one of the following orientations:
  - a. Under a horizontal surface (see A)
  - b. In a horizontal position on a vertical surface (see B)  
**NOTE:** For marine installations, only this orientation is allowed, due to the probability of moisture finding access into the enclosure.
  - c. On a horizontal surface (see C)

*Figure 6 Approved Mounting Orientations*

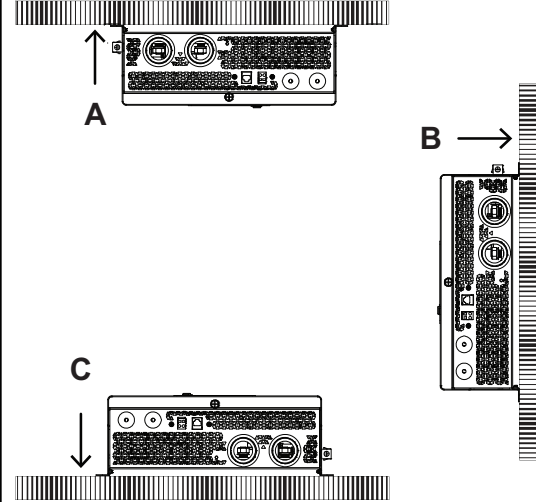

3. Mark the desired number of mounting holes on the wall by placing the unit on the wall.
4. Pilot-drill the mounting holes.
5. Fasten the Freedom X to the mounting surface. If you are mounting the unit on a wall or bulkhead, use #12 or #14 pan-head wood or sheet metal screws to secure it to the framing behind the wall or bulkhead. Alternatively, use nut inserts and 1/4"-20 machine screws.

## Connecting the Equipment Ground

### **! WARNING**

#### **ELECTRIC SHOCK HAZARD**

Never operate the Freedom X without properly connecting the equipment ground. A shock and energy hazard could result from improper grounding.

**Failure to follow these instructions can result in death, serious injury, or equipment damage.**

The Freedom X has a ground lug on the side of the unit as shown in *Connecting the Equipment Ground*. Follow the guidelines in *Connecting the Equipment Ground* to connect the inverter's chassis to the ground.

*Figure 7 DC Panel Connections*

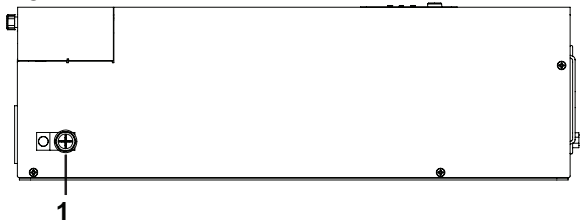

1	DC grounding lug
---	------------------

## Grounding Locations

You must connect the equipment ground lug to a grounding point—usually the vehicle's chassis or DC negative bus ground—using recommended copper wire (if insulated then green insulation with or without one or more yellow stripes) or larger.

Make sure to tighten the bolt on the DC ground lug to a torque of 23 in-lb (2.6 N-m) of force. Apply an anti-corrosion compound to the copper wire prior to connecting to the DC ground lug.

For recommended equipment ground cable size, see below.

Table 7 Equipment DC ground cable size

Application	Minimum equipment ground cable size (Stranded copper cable is required)
Recreational Vehicle <sup>b</sup>	No. 8 AWG
Marine <sup>c</sup>	No. 3 AWG (Freedom X 1000 120VAC 12VDC) No. 1/0 AWG (Freedom X 2000 120VAC 12VDC) No. 2/0 AWG (Freedom X 3000 120VAC 12VDC) No. 3 AWG (Freedom X 2000 120VAC 24VDC)

**NOTE:** There are no restrictions on length for the equipment ground cable but try to make it as short as practical to a secure chassis connection. In general, the equipment ground cable size must not be smaller than one AWG size than the supply cable.

<sup>b</sup>Based on US National Electrical Code NFPA70, Article 551, par. 551-20c and ANSI/RVIA LV, § 2-5.1.

<sup>c</sup>Based on ABYC E-11 § 11.16 and A-31 § 31.6.5.

## Step 4: Connecting the AC Input Wires

### WARNING

#### ELECTRIC SHOCK AND FIRE HAZARDS

Make sure wiring is disconnected from all electrical sources before handling. All wiring must be done in accordance with local and national electrical wiring codes. Do not connect the output terminals of the Freedom X to any incoming AC source.

**Failure to follow these instructions can result in death, serious injury, or equipment damage.**

## General AC Wiring Considerations

### AC Wiring Connectors

Where applicable, connect AC wires with crimp-on splice connectors. The amount of insulation you strip off individual wires will be specified by the connector manufacturer and is different for different types of connectors.

### AC and DC Wiring Separation

Do not mix AC and DC wiring in the same conduit or panel. Where DC and AC wires must cross, make sure they do so at 90° to one another. Consult applicable codes for details about DC and AC wiring in close proximity to each other.



## AC Wiring and GFCIs

You can plug loads of up to 20 amps directly into the GFCI receptacle on the front panel of the Freedom X. If installed, you can also connect the inverter to an existing AC installation and then plug loads into GFCI receptacles connected to that circuit.

If you plan to use the Freedom X GFCI kit on the unit, proceed to *General AC Wiring Considerations on page 26*.

AC wiring includes all the wires and connectors between the AC source and the Freedom X and all wiring between the inverter, the AC panels, GFCI, and circuit breakers. The type and size of the wiring varies with the installation and load. For some RV applications, flexible multiple-strand copper wire is required.

AC wiring must be sized appropriately using conductors with insulation rated at least 75 °C to carry full load current on the input and output AC circuits in accordance with the electrical codes or regulations applicable to your installation. *Table 8* is based on the U.S. National Electrical Code and the Canadian Electrical Code, assuming two-conductor-plus-ground cable, using 75 °C wiring, at an ambient temperature of 30 °C. Other codes and regulations may be applicable to your installation.

*Table 8 Required AC wire size vs. required breaker rating*

	<b>Required Breaker Size (amps)</b>	<b>Required Wire Size</b>
Freedom X	30 A maximum 20 A maximum through a GFCI	10 AWG

The AC input terminal is located inside the unit through the front panel's ½" trade-size hole (or ¾" trade-size knockout<sup>d</sup>) and is labeled properly as **AC IN** or **AC INPUT**. The unit comes with spring clamp-type terminals where individual wires can be attached securely.

## NOTICE

### EQUIPMENT DAMAGE

Make sure the wires are connected properly. The AC wiring terminal blocks are split into input and output sections.

**Failure to follow these instructions can result in equipment damage.**

When making the AC input and AC output connections, observe the correct color code for the appropriate AC wire, as described in *Table 9* below.

<sup>d</sup>Available only to Freedom X 3000 120VAC 12VDC.

Table 9 Color codes for typical AC wiring

Color	AC Wire
Black/Red/Brown	Line
White/light blue	Neutral
Green, green/yellow, or bare copper	Ground (Earth)

## NOTICE

### REVERSE POLARITY DAMAGE

Make sure the wires are connected properly. Improper connections (connecting a line conductor to a neutral conductor, for example) will cause the Freedom X to malfunction and may permanently damage the inverter. Damage caused by a reverse polarity connection is not covered by your warranty.

**Failure to follow these instructions can result in equipment damage.**

## Wiring Knockouts

When installing wires to the AC terminals, the AC input and output holes are provided to accommodate 1/2" trade-size strain relief clamps. If larger cables and strain relief clamps are needed, remove the 3/4" trade-size knockout rings<sup>o</sup>.

<sup>o</sup>Available only to Freedom X 3000 120VAC 12VDC.

Make sure to seal the open 1/2" trade-size holes with the supplied knockout plugs by placing the plugs and firmly pressing them into the holes.

## NOTICE

### EQUIPMENT DAMAGE

Install the supplied AC knockout plugs over the knockout holes when not used for wiring to prevent objects and other material from entering the unit.

**Failure to follow these instructions can result in equipment damage.**

## AC Input Connections

**To make a permanent connection to existing AC wiring:**

1. Ensure AC and DC power sources are turned off.
2. Install the required circuit breaker in the AC distribution panel supplying AC power to the unit.
3. Remove the wiring compartment cover by loosening the captive nut panel screw [1] and lifting the cover up and out.

## WARNING

### ELECTRIC SHOCK HAZARD

Use a screwdriver to loosen the captive nut panel screw.

**Failure to follow these instructions can result in death, serious injury, or equipment damage.**

Figure 8 Loosening the captive nut panel screw

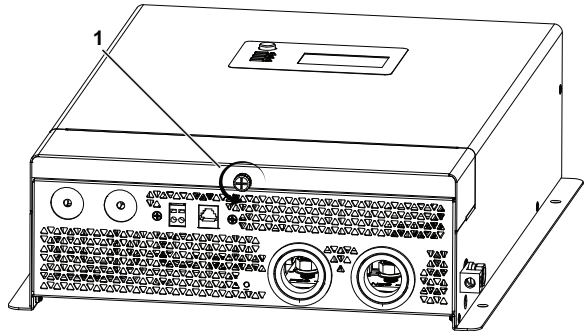

1	Captive nut panel screw
---	-------------------------

4. Strip a single AC input wire, as appropriate. Strip 10 mm off the ends of each of the three the wires (tin the exposed copper wire with lead-free solder using a soldering iron).
5. Remove the knockout and install a 1/2" (or 3/4") strain relief clamp.
6. Route the wires through the strain relief clamp (not shown in the figure).

Figure 9 Routing the wires

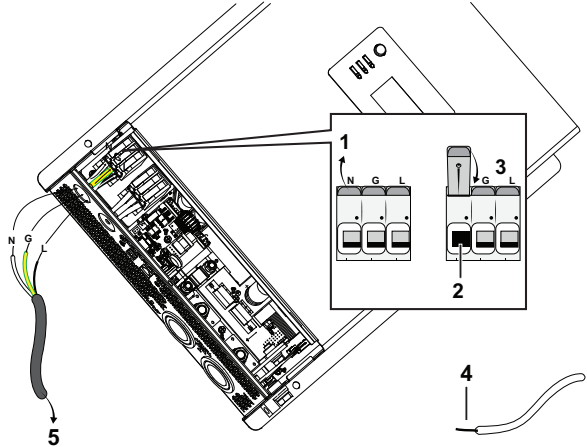

1	step 8a
2	step 8b
3	step 8c
4	10mm
5	to circuit breaker
<b>NOTE:</b> AC input hole - install a strain relief clamp (not shown).	

7. Locate the Neutral, Ground and Line terminals on the AC input terminal labeled as **N**, **G**, and **L** respectively.

<sup>f</sup>Available only to Freedom X 3000 120VAC 12VDC.

8. Connect each AC wire into its corresponding terminal on the no-tool cage clamp terminal block.
  - a. Lift the terminal lever (as shown in the previous figure).
  - b. Insert the wire fully into the open slot.
  - c. Lower the terminal lever to secure the wire in the slot.
9. Make sure that each AC wire is matched and connected to the Neutral (**N**), Ground (**G**), and Line (**L**) connections.

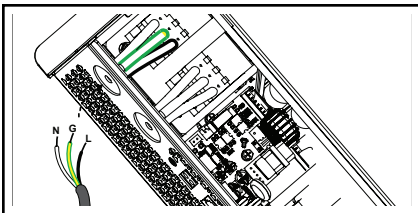

10. Tighten the strain relief clamp to secure the wires.
11. Replace the wiring compartment cover onto the unit (using a #2 Phillips torque screwdriver - see WARNING), if you are not connecting other wires such as for the AC Output. Otherwise, keep the AC compartment open and proceed to the next step.

## **⚠ WARNING**

### **ELECTRICAL SHOCK HAZARD**

Use a torque screwdriver to tighten the captive nut panel screw to 5 in-lb torque of force to ensure a proper ground connection and a required tool access to the wiring compartment.

**Failure to follow these instructions can result in death, serious injury, or equipment damage.**

12. Connect the other end of the wires to the circuit breaker in the AC distribution panel supplying AC power to the unit.

## Step 5: Connecting AC Output to an Existing AC Circuit

### **WARNING**

#### **ELECTRIC SHOCK AND FIRE HAZARDS**

Make sure wiring is disconnected from all electrical sources before handling. All wiring must be done in accordance with local and national electrical wiring codes.

**Failure to follow these instructions can result in death, serious injury, or equipment damage.**

### **NOTICE**

#### **EQUIPMENT DAMAGE**

- Do not connect any AC source (such as a generator or utility power) to the AC output wiring of the Freedom X.
- The Freedom X will not operate if its output is connected to AC voltage from another source, and potentially hazardous or damaging conditions may occur. These conditions can occur even if the inverter is off.

**Failure to follow these instructions can result in equipment damage.**

Do not connect the Freedom X to an AC branch circuit that has high-power consumption loads.

The Freedom X will not operate electric heaters, air conditioners, stoves, and other electrical appliances that consume more than its rated watts.

A manufacturer-tested and approved GFCI must be connected to the Freedom X AC output, and GFCI protection must be provided on every receptacle connected to the AC hard wired installation. Other types may fail to operate properly when connected to the Freedom X. See *Ground Fault Circuit Interrupters (GFCIs)* on page 22.

## AC Output Connections

Figure 10 Routing the wires

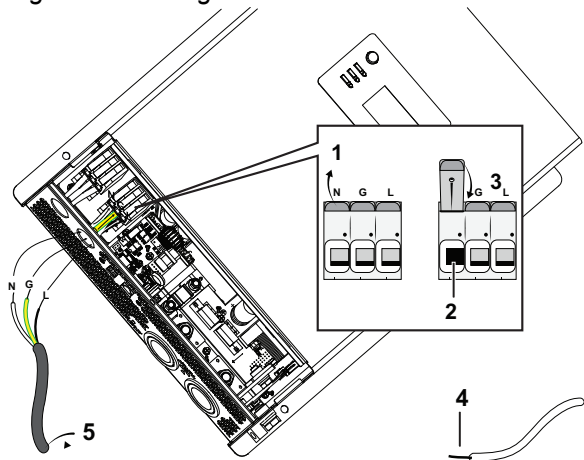

1	step 7a
2	step 7b
3	step 7c
4	10mm
5	to circuit breaker
<b>NOTE:</b> AC output hole - install a strain relief clamp (not shown).	

### To make a permanent connection to existing AC wiring:

1. Ensure AC and DC power sources are turned off, if not already done from *AC Output Connections on page 32*.

2. Install the required circuit breaker in the inverter distribution panel receiving AC power from the inverter.
3. Remove the wiring compartment cover, if not already done from *AC Output Connections on page 32*.

## **⚠ WARNING**

### **ELECTRIC SHOCK HAZARD**

Use a screwdriver to loosen the captive nut panel screw.

**Failure to follow these instructions can result in death, serious injury, or equipment damage.**

4. Strip a single AC output wire, as appropriate. Strip 10 mm off the ends of each of the three the wires (tin the exposed copper wire with lead-free solder using a soldering iron).
5. Remove the knockout and install a 1/2" (or 3/4") strain relief clamp.
6. Route the wires through the strain relief clamp (not shown in the figure).
7. Connect each AC wire into its corresponding terminal on the no-tool cage clamp terminal block.
  - a. Lift the terminal lever (as shown on the figure).
  - b. Insert the wire fully into the open slot.
  - c. Lower the terminal lever to secure the wire in the slot.
8. Make sure that each AC wire is matched and connected to

9Available only to Freedom X 3000 120VAC 12VDC.

the Neutral (N), Ground (G), and Line (L) connections.

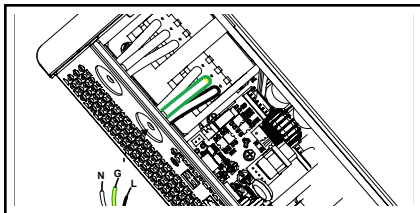

9. Tighten the strain relief clamp to secure the wires.
10. Replace the wiring compartment cover (using a #2 Phillips torque screwdriver - see WARNING), if you are finished with connecting all the AC wires in the unit (and installing the GFCI).

## **⚠ WARNING**

### **ELECTRICAL SHOCK HAZARD**

Use a torque screwdriver to tighten the captive nut panel screw to 5 in-lb torque of force to ensure a proper ground connection and a required tool access to the wiring compartment.

**Failure to follow these instructions can result in death, serious injury, or equipment damage.**

11. Connect the other end of the wires to a circuit breaker in the inverter distribution panel.

## **Step 6: Connecting the DC Cables**

### **NOTICE**

#### **REVERSE POLARITY**

- Check cable polarity at both the battery and the Freedom X before making the final DC connection. Positive must be connected to positive; negative must be connected to negative. Check to see if the reverse polarity LED (see *Step 6: Connecting the DC Cables*) is not illuminated.
- Reversing the positive and negative battery cables will blow a fuse in the Freedom X and void your warranty.

**Failure to follow these instructions can result in equipment damage.**

## **⚠ WARNING**

#### **FIRE HAZARD**

Use only copper wire rated 75 °C minimum. Make sure all DC connections are tight to a torque of 71–80 in-lb (8–9Nm) of force. Loose connections will overheat.

**Failure to follow these instructions can result in death, serious injury, or equipment damage.**

Follow the procedure given below to connect the battery leads to the terminals on the DC end. The cables should be as short as

possible and large enough to handle the required current, in accordance with the electrical codes or regulations applicable to your installation. *Table 6* specifies the minimum DC cable size and maximum fuse size for the Freedom X.

If at all possible, minimize routing your DC cables through an electrical distribution panel, battery isolator, or other device that will cause additional voltage drops which can degrade the inverter's ability to operate the loads.

*Figure 11* shows the DC end for your reference. The reverse polarity LED will light up when the DC cables were reversed during installation. Reversing the connections may void the warranty.

*Figure 11 DC End*

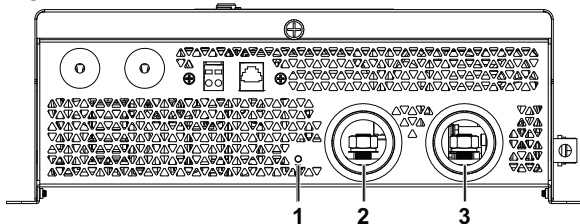

1	reverse polarity LED
2	positive (+)
3	negative (-)

**To make the DC connections:**

1. Make sure the inverter is off and no AC or DC is connected to the unit.
2. Remove the wiring compartment cover by loosening the captive nut panel screw.

**⚠ WARNING**

**ELECTRIC SHOCK HAZARD**

Use a screwdriver to loosen the captive nut panel screw.

**Failure to follow these instructions can result in death, serious injury, or equipment damage.**

3. Loosen the DC terminal nuts from the terminal bolts and set them aside for later.
  4. Strip ½" (13 mm) to ¾" (19 mm) insulation from one end of each cable. The amount stripped off will depend on the terminals chosen.
  5. Attach the connectors that will secure the cables to the battery, to the disconnect/battery selector switch, and the fuse block. The connectors you use must create a permanent, low-resistance connection. It is recommended to use approved and certified cable ring lugs. Use the tool recommended by the terminal manufacturer. Make sure no stray wires protrude from the lug or terminal.
- NOTE:** You may find it more convenient to have the cable lugs attached by the company that sells you the cable and/or connectors.



6. Strip  $\frac{1}{2}$ " (13 mm) to  $\frac{3}{4}$ " (19 mm) of insulation from each cable end that will be connected to the inverter cable. The amount stripped off will depend on the terminals chosen.
7. Attach the cable ring lug that will join the cable to the inverter DC terminal. Cover the lug stem with heat shrink insulation (see *Step 6: Connecting the DC Cables*) to ensure that the lug does not touch the enclosure.
8. Install a fuse and fuse holder in the cable that will be used for the positive side of the DC circuit. The fuse must:
  - a. be as close to the battery positive terminal as possible
  - b. be rated for DC circuits
  - c. have an Ampere Interrupting Capacity (AIC) that exceeds the short-circuit current available from the battery (that is, Class T fuse)
9. To prevent sparking when making the connection, ensure the disconnect/battery selector switch is off.
10. Route the positive cable through the left side strain relief clamp and attach the cable lug on the positive cable to the positive DC terminal on the inverter.
11. Fasten the DC terminal nut (set aside earlier) to the terminal bolt. Tighten the nut to a torque of 71–80 in-lb (8–9 N-m) of force. Do not overtighten. Make the connection snug enough so the cable lug does not move around on the DC terminal. Center it through the DC knockout hole and do not let it touch the edge. See *Step 6: Connecting the DC Cables on page 33*.

## WARNING

### ELECTRICAL SHOCK HAZARD

- Tighten the nuts on the DC terminals properly. Loose connections cause excessive voltage drop and may cause overheated wires and melted insulation.
- Do not over-tighten the nut on the DC input terminals because damage to the DC input terminals may result. Use a torque screwdriver to tighten the nut to a maximum torque of 80 in-lb (9 N-m) of force.

**Failure to follow these instructions can result in death, serious injury, or equipment damage.**

## NOTICE

### REVERSE POLARITY

- Check cable polarity at both the battery and the Freedom X before making the final DC connection. Positive must be connected to positive; negative must be connected to negative. Check to see if the reverse polarity LED (see *Step 6: Connecting the DC Cables*) is not illuminated.
- Reversing the positive and negative battery cables will blow a fuse in the Freedom X and void your warranty.

**Failure to follow these instructions can result in equipment damage.**

Figure 12 DC Cable Connections

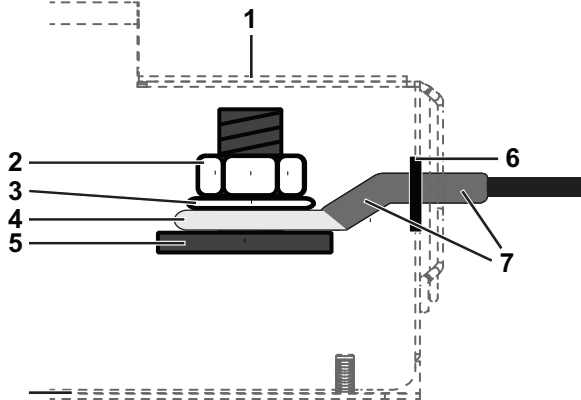

1	enclosure outline (DC compartment side view),
2	DC terminal nut
3	DC nut lock washer
4	cable ring lug
5	DC terminal
6	DC knockout hole
7	DC cable with heat shrink insulation covering the lug stem
<b>NOTE:</b> The DC cable lug stem must be fully insulated with the heat shrink.	

- Before proceeding, double check that the cable you have just installed connects the positive DC terminal of the inverter to the disconnect/battery selector switch, fuse holder, and that the other end of the fuse holder is connected to the positive terminal of the battery.

## **⚠ WARNING**

### **FIRE HAZARD**

Do not complete the next step if flammable fumes are present. Explosion or fire may result if the disconnect/battery selector switch is not in the off position. Thoroughly ventilate the battery compartment before making this connection.

**Failure to follow these instructions can result in death, serious injury, or equipment damage.**

- Route the negative cable through the right side strain relief clamp and connect the cable from the negative post of the battery to the negative DC terminal of the inverter.
- Fasten the DC terminal nut (set aside earlier) to the terminal bolt. Tighten the nut to a torque of 71–80 in-lb (8–9 N-m) of force. Do not overtighten. Make the connection snug enough so the cable lug does not move around on the DC terminal. Center it through the DC knockout hole and do not let it touch the edge.
- Replace the wiring compartment cover by tightening the captive nut panel screw. See the following electrical shock hazard warning.

## WARNING

### ELECTRICAL SHOCK HAZARD

Use a torque screwdriver to tighten the captive nut panel screw to 5 in-lb torque of force to ensure a proper ground connection and a required tool access to the wiring compartment.

**Failure to follow these instructions can result in death, serious injury, or equipment damage.**

## DC Grounding

To connect the DC ground:

1. The equipment grounding lug (DC ground lug) on the DC end of the Freedom X is used to connect the chassis of the Freedom X to your system's DC negative connection or grounding bus point as required by electrical regulations.
2. Use copper wire that is either bare or provided with green insulation. Do not use the DC ground lug for your AC grounding. See the AC wiring instructions in this section.
3. Follow the guidelines below that correspond to the specific type of installation. These guidelines assume you are using the DC supply cable and fuse sizes recommended in this guide. If you are using different sizes, refer to the applicable installation code for DC grounding details.
4. See *Figure 7* for the location of the DC ground lug. Make sure to tighten the bolt on the DC ground lug to a torque of 23 in-lb (2.6 N-m) of force. Apply an anti-corrosion compound to the copper wire prior to connecting to the DC ground lug.

## Recreational Vehicle

Use 8AWG minimum-sized, stranded copper wire and connect it between the Chassis Ground lug and the vehicle's DC grounding point (usually the vehicle chassis or a dedicated DC ground bus). See regulatory references below.

## Marine

Use copper wire that is bare or has insulation rated minimum 105 °C, and connect it between the Chassis Ground lug and the boat's DC grounding bus or engine negative bus. For the Freedom X 1000 120VAC 12VDC and Freedom X 2000 120VAC 24VDC, use a wire of gauge 3AWG minimum. For the Freedom X 2000 120VAC 12VDC, use a wire of gauge 1/0AWG minimum. For the Freedom X 3000 120VAC 12VDC, use a wire of gauge 1/0AWG minimum. See regulatory references below.

### Regulatory references

For DC voltage systems under 50 VDC in an RV installation, an 8AWG copper bonding conductor would be acceptable for the inverter enclosure ground bonding only per UL458 §63.6; §30.10 standard [≤ 150 mV @ 30A connection, per §63.9; §63.10] and per ANSI/RVIA LV code §2-5.1 Bonding Voltage Converter Enclosures. The "house" battery system must, however, be ground bonded per ANSI/RVIA LV code §2-4 Auxiliary Battery Grounding; and  
For DC voltage systems under 50 VDC in a marine installation, [UL458 §SA7.2] a DC Grounding conductor shall not be smaller than one size under that required for current carrying conductors supplying the device per ABYC E-11 §11.16.2 but not less than 8AWG [USGC 46 CFR §111.05-31].

## Connecting to ACC Signal

To enable ignition control:

1. Ensure that AC and DC power are both OFF.
2. Ensure the vehicle's ignition is turned to OFF position. It is highly recommended to remove battery power by disconnecting the vehicle's battery cables. Refer to the vehicle's user manual for proper instructions on how to disconnect the battery cables.
3. Locate the vehicle's ignition control wire from the vehicle's ignition circuit. This wire must be fused appropriately at no more than 5 amps. Refer to the vehicle's user manual for guidance.
4. Locate the ACC input (ignition signal input) terminal on the right side of the connector. The left terminal is not used at this time. See *Figure 13*

*Figure 13 Ignition signal (ACC) input terminal*

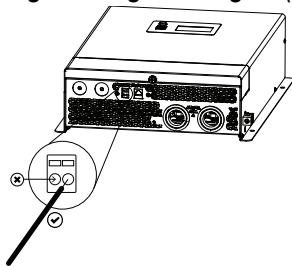

5. Using a 3mm slot long neck screwdriver, push into the rectangular slot to release the spring clamp.
6. Insert the ignition control wire into the round ACC input terminal slot.

7. Pull the screwdriver out to engage the spring clamp and secure the wire to the terminal.

### Description of Ignition Control Features

For information about the features and instructions on changing the ignition control features, see *Operation on page 43*.

*Table 10 Ignition Control Features*

<b>Ignition Auto-on (A&amp;O)</b>	This setting allows the inverter to operate (Battery mode) automatically when an ignition control wire is connected to the ACC input and a valid ignition signal is constantly detected. The inverter works in tandem with the vehicle's ignition circuit.
<b>Ignition Lock-out (L&amp;O)</b>	This setting allows the inverter to operate (Battery mode) when an ignition control wire is connected to the ACC input terminal and a valid ignition signal is constantly detected.  When enabled, you have to manually press the Power button on the display panel to operate the inverter.
<b>Off (OFF)</b>	To completely disable the ignition control features do the following:  Set Ignition Control to Off (OFF) using the Select buttons on the Display panel.

## Step 7: Connecting to Port(s) on the Freedom X

### Connecting to the Remote Port

The Freedom X can accommodate the Freedom X Remote Panel with cable (PN: 808-0817-01) (sold separately; comes with 25ft-cable) or the Freedom X Remote Panel unit (PN: 808-0817) (sold separately; unit only without cable).

To connect the remote panel to the remote port:

- Plug the remote panel unit's cable connector to the RJ12 Remote port on the unit.

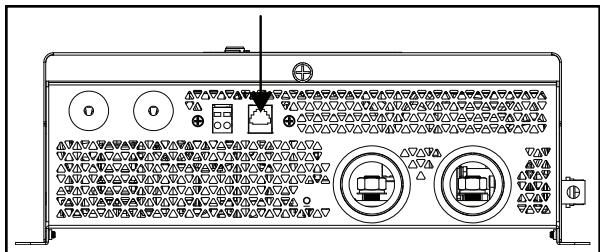

**NOTE:** When the remote panel is connected, turn the inverter's power button to the Standby mode (up position). This allows the remote panel to control the inverter's power status.

## Step 8: Testing Your Installation

### ⚠ WARNING

#### ELECTRIC SHOCK HAZARD

Pressing the Power button to turn the Freedom X inverter to Standby mode on the display panel does not disconnect DC or AC input power to the Freedom X. If shore power is present at AC input terminals, it will pass through to the AC output.

**Failure to follow these instructions can result in death, serious injury, or equipment damage.**

There are two tests to be performed. The first test verifies that the Freedom X is inverting DC battery power and delivering AC power to its output.

The second test is intended for installations where AC input and output is hard wired to the Freedom X. This test verifies that the Freedom X transfers from inverter power to shore power when shore power is present.

**NOTE:** Shore power (pass-through) refers to the AC input power from a utility grid, generator or external AC source.

When you are ready to test your installation and operate the Freedom X, close the DC fuse and Disconnect or the DC circuit breaker to supply DC power to the Freedom X.

## Testing in Battery Mode

To test the Freedom X:

1. For hard wired installations, ensure shore power is not present.
2. Press the Power button to turn the inverter on. The green status indicator LED for Battery mode (Inverter mode) is illuminated. See *Status LED Indicators on page 44*.
3. Plug a test load, such as a lamp within the power rating of the inverter into the Freedom X GFCI or an AC outlet hard wired to the Freedom X.
4. Turn the lamp on to verify that it operates.

If the lamp operates, your installation is successful. If your installation has AC input and output hard wired to the Freedom X, proceed to *Testing in Grid Mode*.

If the status LED on the display panel glows red, see the Troubleshooting chapter.

## Testing in Grid Mode

To test the Freedom X:

- With the test load from the previous test still connected and operating, connect the shore power source.
- The Freedom X transfers the test load to shore power. The green LED indicating grid mode turns on and the LCD screen displays the **AC MODE** icon.
- If the test load operates, your installation is successful.

**NOTE:** If the Power button on the Freedom X is turned ON, the Freedom X will automatically supply the appliances with inverter power if the shore power source fails or becomes disconnected.

If the Power button on the Freedom X is turned ON and shore power voltage is too low (less than 90 volts AC), the unit will transfer to inverter power to continue running your appliances.

**NOTE:** Whether or not the Power button is turned ON, shore power will pass through the Freedom X to the output when shore power is within normal operating range.

**NOTE:** In the event of low or no battery voltage, shore power will pass through the Freedom X to the output even when shore power is outside the normal operating range.

# Marine Installation

Figure 14 illustrates a typical marine installation with the following components:

1	20-pin harness accessory <b>Not applicable for this product.</b>
2	Equipment ground – Engine negative bus / DC ground bus
3	Freedom X
4	DC fuse/disconnect/DC circuit breaker
5	12V/24V (as applicable) deep cycle battery bank and protected by a DC fuse in the positive cable
6	Battery isolator
7	DC alternator
8	To engine
9	Equipment ground – Engine negative bus / DC ground bus
10	Starting battery
11	AC load panel with branch circuit breakers that supply only loads that run off the Freedom X
12	AC source panel that includes a max 30A (or a 15A if using a GFCI) circuit breaker that supplies the Freedom X
13	Shore power – AC power supplied from a shore power connector
Not shown	Drip shield (see next page)

Figure 14 Typical Marine Installation

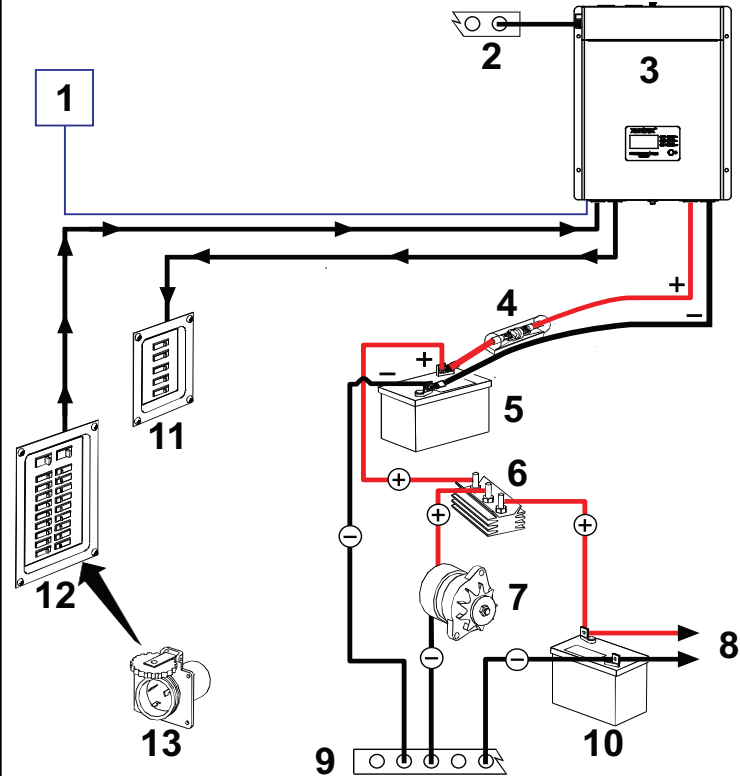

## Drip Shield Installation

The drip shields help to protect the unit from dripping or splashing liquids, which will cause a shock hazard when moisture comes in contact with electrical circuits in the unit. The drip shields are especially useful in marine installations where water from condensation, rain, or sea may come into contact with the Freedom X.

### **⚠ WARNING**

#### **ELECTRICAL SHOCK HAZARD**

Place this unit in normally dry areas only. Operating the unit under wet conditions may expose you to a shock hazard. Installing drip shields may not entirely protect you from this hazard. Do not operate the unit when it is wet.

**Failure to follow these instructions can result in death, serious injury, or equipment damage.**

You may purchase the drip shield set by contacting customer support. When ordering, mention part number 808-1050.

*Figure 15 Drip shields*

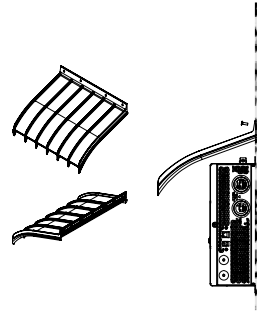

#### **To install the drip shields:**

1. Gather the four screws needed to fasten a single drip shield to a wall.
2. Locate an appropriate setting for the drip shields above the Freedom X making sure you cover the entire width of the unit. You can overlay the shields as shown in *Figure 16*.
3. Fasten the screws through the holes in the drip shield into the wall. See *Figure 15*.

*Figure 16 Typical Drip Shield Placement on a Freedom X*

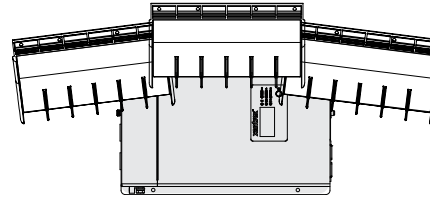



## 4 OPERATION

This section includes descriptions of the different modes and settings of the Freedom X Inverter.

This section includes:





<b>Freedom X Display Panel</b> .....	<b>44</b>
Status LED Indicators .....	44
Function Buttons .....	45
LCD Screen .....	45
LCD Screen Icons .....	46
<b>Viewing Information During Battery Mode</b> .....	<b>47</b>
<b>Viewing Information During Grid Mode</b> .....	<b>49</b>
<b>Adjusting Feature Settings in Configuration Mode</b> .....	<b>51</b>
Settings .....	52
<b>Operating in Battery Mode</b> .....	<b>56</b>
Turning Inverter Operation ON and OFF .....	56
Power Save Timer .....	57
Power Save Mode .....	57
Checking Battery Status .....	58
Checking Output Power .....	58

Operating Several Loads at Once .....	58
Turning the Audible Alarm ON or OFF .....	58
<b>Operating During Transition Between Grid Mode and Battery Mode</b> .....	<b>59</b>
Transitioning from Grid Mode to Battery Mode .....	59
Transitioning from Battery Mode to Grid Mode .....	60
<b>Operating Limits</b> .....	<b>61</b>
Power Output .....	61
Input Voltage .....	62
Overload Conditions .....	63
High Surge Loads .....	63
Over-temperature Conditions .....	64

# Freedom X Display Panel





Figure 17 Display Panel







1	LCD screen
2	Status LED indicators
3	 see "Function Buttons" on the facing page
4	 see "Function Buttons" on the facing page
5	 see "Function Buttons" on the facing page
6	 see "Function Buttons" on the facing page

**NOTE:** Briefly pressing any function button activates backlight illumination. After 60 seconds of inactivity, backlight illumination turns off.

## Status LED Indicators

Indicator	Definition
	Solid green. Indicates grid mode in which shore power is available and passing through to the loads.
	Solid green. Indicates Battery mode (Inverter mode) in which the inverter is running and supplying power to the loads from the battery.
	Solid red. Indicates error or fault mode and is accompanied by an error code displayed on the LCD screen. For a list of error codes, see <i>Motor Loads</i> on page 76.
	Flashing red. Indicates a Warning condition and is accompanied by an error code and a sounding alarm. For a list of error codes, see <i>Motor Loads</i> on page 76.

## Function Buttons

Button	Definition
	Return to default screen or exit setting mode
	Next screen or next selection Press and hold for three seconds to go back one step
	To enter the setting mode or to confirm the setting
	Turns on inverter operation or to Standby mode

## LCD Screen





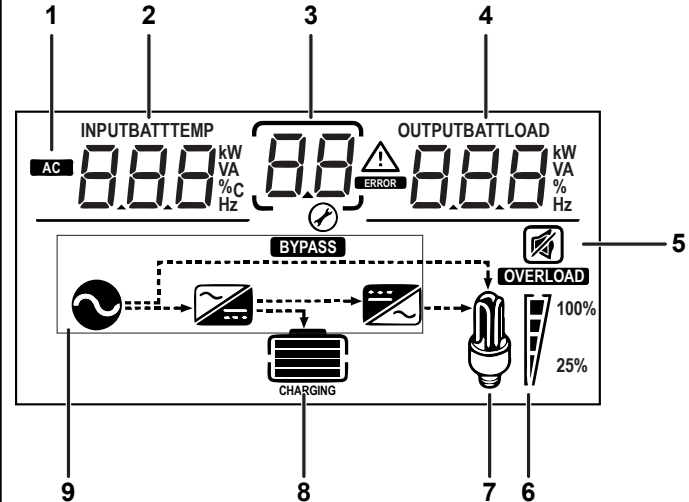

The LCD Screen changes depending on the operating mode of the inverter.







Figure 18 Parts of the LCD Screen



1	AC IN or AC OUT indicator	6	load power level indicator
2	left LCD display	7	load indicator
3	middle LCD display	8	battery level indicator
4	right LCD display	9	mode indicator
5	alarm off indicator		

## LCD Screen Icons

Icon	Definition
	AC input and output indicator.
	The wrench icon underneath a number is displayed during configuration mode.
	An error event with its corresponding number is displayed here.
	A warning event with its corresponding number is displayed here.
	The battery icon indicates remaining battery power. One bar = 1-25%, two bars = 25-50%, three bars = 50-75%, and four bars = 75-100%.
	Shows an overload condition.

Icon	Definition
	The load icon is displayed if there is voltage available at the AC output.
	The bar represents load consumption levels. 100% is an indication of full capacity and 25% indicates low consumption. All the bars disappear at < 20 watts, and AC load indicates zero watt power.
	Shows up in grid mode when AC shore power is present. If the power is being qualified, then this icon will flash.
	Shows that the unit is in grid mode and is bypassing shore power directly to the loads.
	This icon shows when there is power conversion from DC to AC - inverting.
	The alarm buzzer is muted.

# Viewing Information During Battery Mode

The LCD screen displays information related to battery mode operation.

- Press the Scroll  button to move from screen to screen. Press and hold for three seconds to go back one step.

**NOTE:** The example screens below show information for 12VDC models only.

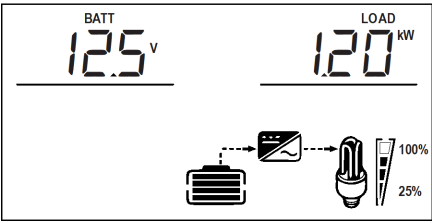
Info and Setting	LCD Screen
<p>Screen 1 of 4 - Battery Voltage/Load Wattage</p> <p>This is the home screen.</p>	 <p>battery voltage = 12.5V, AC load = 1.2kW</p>

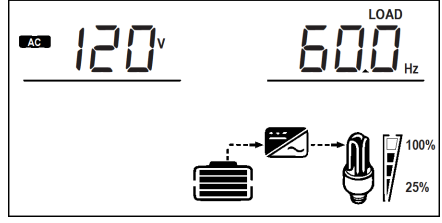
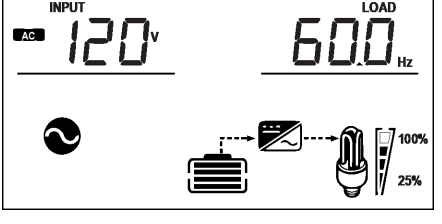
Info and Setting	LCD Screen
<p>Screen 2 of 4 - AC Output Voltage/Frequency</p>	 <p>output voltage = 120V, output frequency = 60Hz</p>
<p>Screen 3 of 4 - AC Input Voltage/Frequency</p> <p>Screen shows up when utility AC is connected.</p>	 <p>input voltage = 120V, input frequency = 60Hz</p>

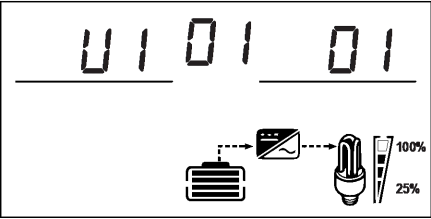
Info and Setting	LCD Screen
Screen 4 of 4 - Firmware version	 <p>The LCD screen displays the firmware version 'U1 01 01' in a large, segmented font. Below the text are four icons: a battery, a Wi-Fi signal icon, a light bulb, and a vertical bar with '100%' and '25%' labels. Dashed lines connect the battery, Wi-Fi, and light bulb icons to the vertical bar.</p>
	Firmware version = U1 1.01

# Viewing Information During Grid Mode

1. The LCD screen displays information related to AC bypass operation.
2. Press the Scroll  button to move from screen to screen. Press and hold for three seconds to go back one step.
3. Press **ESC** to return to the home screen.

**NOTE:** After one minute of inactivity in the other screens, the LCD will go back to the home screen.

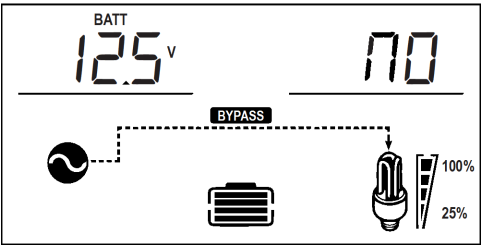
Info and Setting	LCD Screen
<p>Screen 1 of 4 - Battery Voltage</p> <p>This is the home screen.</p>	 <p>battery voltage = 12.5V</p>

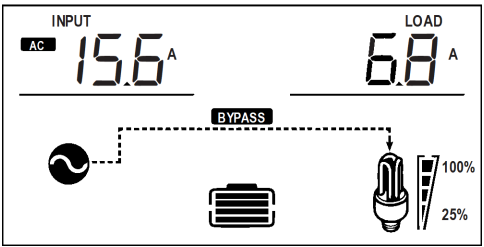
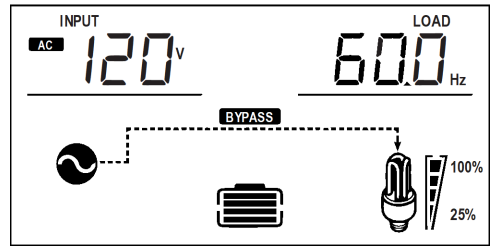
Info and Setting	LCD Screen
<p>Screen 2 of 4 - AC input current/AC load current</p>	 <p>input current = 15.6A, load current = 6.8A</p>
<p>Screen 3 of 4 - AC input voltage/AC input frequency</p>	 <p>input voltage = 120V, input frequency = 60Hz</p>

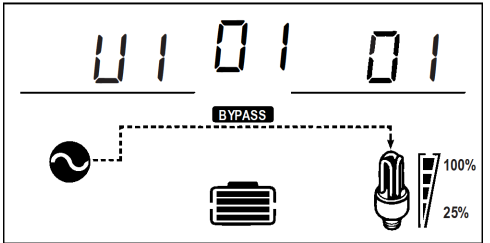
Info and Setting	LCD Screen
Screen 4 of 4 - Firmware version	 <p>Firmware version = U1 1.01</p>



# Adjusting Feature Settings in Configuration Mode

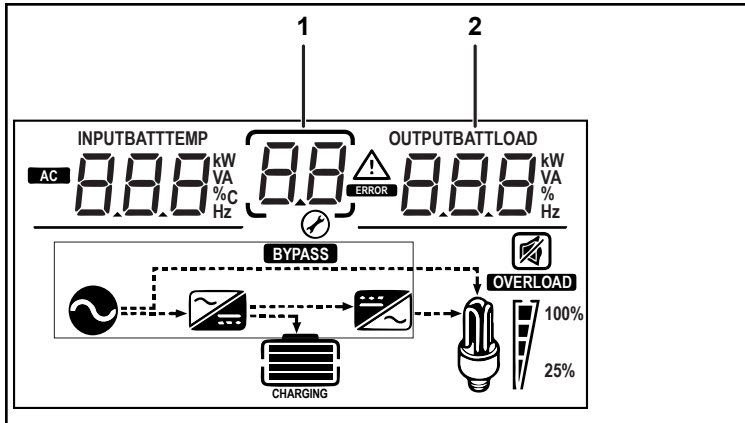

The **OK**, Scroll , and **ESC** buttons can be used to cycle through the various feature settings:

1. Press and hold the **OK** button for three seconds to enter the feature settings mode.
2. Press the Scroll  button to move through the different feature settings. Press and hold for three seconds to go back one step.



1	setting number is displayed here
2	setting value is displayed here

## To change the default value to a different value:

1. Press and hold the **OK** button for three seconds to enter the feature settings mode.
2. Press the Scroll  button to move through the different feature settings. Press and hold for three seconds to go back one step.
3. Press the **OK** button to select a setting number and change its value.
4. Press the Scroll  button to change the value until you reach the desired value.
5. Press the **OK** button to confirm the change.
6. Repeat the previous steps to set other feature settings.
7. Press the **ESC** button to exit the feature settings mode.

## Settings

Setting Name	Setting Number	Default Value	Range of Values	Description
Inverter Ignition Control	01	OFF	OFF LOt AtD	See <i>Description of Ignition Control Features on page 38</i> .
LBCO Voltage (12VDC models)	02	10.5	10.0 to 12.8	The voltage setting value can be adjusted by 0.1 increments. The inverter is able to recover automatically at LBCO voltage + 0.2 volts.
LBCO Voltage (24VDC model)		21.0	20.0 to 25.6	
LBCO Shutdown Delay Timer	03	300	1 to 300	When the range is from 1 to 20, the timer setting value can be adjusted by 1-second increments. When the range is from 20 to 300, the timer setting value can be adjusted by 10-second increments.

Setting Name	Setting Number	Default Value	Range of Values	Description
LBCO Recovery Voltage (12VDC models)	04	13.1	10.2 to 16.0 and OFF	The range is from LBCO voltage + 0.2 to 16, adjusted by 0.1 increments. Selecting OFF or a higher value than the battery's actual fully-charged voltage level will disable the auto-recovery feature. You may manually reset the inverter when the low battery cut off event occurs.
LBCO Recovery Voltage (24VDC model)		26.2	20.2 to 32.00 and OFF	The range is from LBCO voltage + 0.2 to 32, adjusted by 0.1 increments. Selecting OFF or a higher value than the battery's actual fully-charged voltage level will disable the auto-recovery feature. You may manually reset the inverter when the low battery cut off event occurs.
Power Save Time	05	25	OFF, 1 to 25	The range is from 1 to 25, adjusted by 1-hour increments. The next setting after 25 is OFF.
Power Save (Load Sensing) Mode	06	01 5	0nA (enable), 01 5 (disable)	When enabled, the inverter's "no load" loss can be reduced further when total load is less than 25 watts.
Output Frequency	07	60	60 50	After changing the output frequency setting, turn the unit off and then on again, in order for the change to take effect.
Output Voltage	08	120	120 110 108	

<b>Setting Name</b>	<b>Setting Number</b>	<b>Default Value</b>	<b>Range of Values</b>	<b>Description</b>
Inverter Output Power Limit (Freedom X 1000 120VAC 12VDC)	09	1.0	0.1 to 1.0	The wattage setting value can be adjusted by 100-watt increments. Use with Inverter Output Power Limit Timer especially when pairing with a lithium ion battery. 0.1 is equivalent to 100 watts.
Inverter Output Power Limit (Freedom X 2000 120VAC 12VDC/24VDC)	09	2.0	0.1 to 2.0	
Inverter Output Power Limit (Freedom X 3000 120VAC 12VDC)	09	3.0	0.1 to 3.0	
Inverter Output Power Limit Timer	10	300	1 to 300	When the range is from 1 to 20, the timer setting value can be adjusted by 1-second increments. When the range is from 20 to 300, the timer setting value can be adjusted by 10-second increments. Use with Inverter Output Power especially when pairing with a lithium ion battery. The timer is automatically disabled if the maximum Inverter Output Power limit is selected.

Setting Name	Setting Number	Default Value	Range of Values	Description
Transfer Mode	11	<i>AFL</i>	<i>AFL</i> (appliance) <i>UPS</i> (UPS)	Selecting <i>AFL</i> - appliance sets the transfer time from line to battery to 20 ms. Selecting <i>UPS</i> (uninterruptible power supply) sets the transfer time from line to battery to 10 ms. <b>NOTE:</b> Do not connect motor loads when in UPS transfer mode. See <i>Troubleshooting on page 67</i> .
Utility AC Under Voltage Level	12	90	85 to 110	
Inverter Shutdown Recovery	13	<i>AR</i>	<i>AR</i> (auto-restart) <i>MR</i> (manual restart)	The inverter shuts down when there is an over temperature, overload, and short circuit condition. Selecting <i>AR</i> (auto-restart) will allow the inverter to recover automatically from a shutdown up to three times maximum. Selecting <i>MR</i> (manual restart) allows the user to restart the inverter by performing a manual reset, that is, by acknowledging the restart via the display panel.
Audible Alarm	14	<i>BA</i>	<i>BA</i> Audible <i>BF</i> (Mute)	The alarm beeps once every five seconds.
Reset all settings to their default values	99	<i>DF</i>	<i>DF</i> (as is) <i>DEF</i> (default)	<i>DF</i> refers to current settings. Choose <i>DEF</i> to restore all settings to their default values.

## Operating in Battery Mode

The Freedom X is in Battery Mode (also called Inverter Mode) when all the following conditions exist:

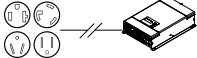
- inverter power button is ON  (down position) or ignition auto-on is activated
- shore power is not presently available 
- battery has sufficient power

Inverter operation means that DC battery power is presently being converted to utility grade AC power, powering equipment and appliances connected to the AC output terminal of the unit. The green status LED lights up to indicate the Freedom X is using the battery to power the equipment and appliances.

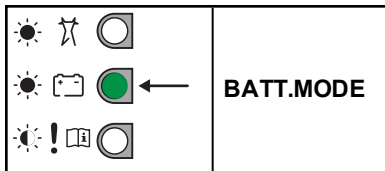

## Turning Inverter Operation ON and OFF

There are two ways to operate the Freedom X's inverter.

1. Press the Power button to a down position (it is in Standby mode in the up position).
2. When the inverter's Ignition Control feature is set to Auto-on (A-E ), a +12VDC signal is present on the ACC input<sup>b</sup>.

### **WARNING**

#### **ELECTRICAL SHOCK HAZARD**

Turning the Power button to Standby mode does not disconnect DC battery power from the Freedom X. You must disconnect from all power sources before working on any circuits connected to the unit.

**Failure to follow these instructions can result in death, serious injury, or equipment damage.**

To prevent unnecessary battery discharge, press the Power button to Standby mode when you are not using the Freedom X.

<sup>a</sup>See *Adjusting Feature Settings in Configuration Mode* on page 51.

<sup>b</sup>When the vehicle's ignition switch is On or the vehicle's engine is running.

## Power Save Timer

The Power Save Timer is an adjustable countdown timer from 1 to 25 hours (25 hours is the default) that automatically shuts down inverter operation to reduce battery discharge and preserve battery life. During continuous inverter operation, the countdown is initiated when power from the AC load drops to less than approximately 50 watts and remains below this level. After reaching the end of the countdown timer the inverter automatically shuts down.

To change the countdown timer, see *Settings on page 52*.

## Power Save Mode

By enabling the power save mode, the inverter can automatically go to load sense mode by sending short pulses to further reduce the battery discharge. Power save mode ends when a load greater than 25 W is connected.

## Checking Battery Status

During inverter operation (in battery mode), you can check the battery status by observing the battery capacity indicator on the LCD screen. The battery voltage appears in the left side of LCD screen.

The normal operating battery voltage range is between 11 and 15 volts.

## Checking Output Power

When the inverter is in operation (in battery mode), you can check how much power (displayed in kW) the Freedom X is supplying to the connected loads by observing the load capacity indicator on the LCD screen. The battery discharge amperage appears in the right side of the LCD screen.

## Operating Several Loads at Once

If you are going to operate several loads from the Freedom X, turn them on one at a time after you have turned the inverter on.

Turning loads on separately helps to ensure that the inverter does not have to deliver the starting current for all the loads at once, and will help prevent an overload shutdown.

## Turning the Audible Alarm ON or OFF

The Freedom X's audible alarm can be muted. See *Adjusting Feature Settings in Configuration Mode on page 51*.

Any warnings such as error or fault conditions or imminent shutdown are both displayed on the LCD screen and sounded on the alarm speakers. See *To manually reset the alarm: on page 58*.

**Audible alarm for warning:** The unit beeps once when a warning condition is detected.

**Audible alarm for error:** The unit beeps once every five seconds for one minute.

### To mute the alarm:

- Press any one of the three function buttons.

The alarm is automatically muted after one minute. But the error code continues to be displayed until the error is cleared.

### To manually reset the alarm:

1. Press the Power button to turn it Off (from a down position to up) and press again to turn it On to reset an active alarm and clear the error.
2. If the Inverter Ignition Control is set to auto-on, toggle the ignition signal to clear the alarm and error.
3. Toggle the AC input power to force the transition between grid mode and battery mode. This action clears the alarm and error.



## Operating During Transition Between Grid Mode and Battery Mode

The Freedom X's advanced power management is capable of transitioning power from an AC source to DC source within a fraction of a second and vice-versa.

The Freedom X automatically detects when shore power is present and when it becomes unavailable or drops to less than 90 volts AC.

The transfer time can be set to two settings. For details see *Adjusting Feature Settings in Configuration Mode on page 51*.

### **NOTICE**

#### **EQUIPMENT DAMAGE**

- When the transfer mode is set to *UPS*, connect only sensitive digital equipment that requires fast AC transfer times.
- Appliances with motors, compressors, and heating elements do not require a transfer mode of *UPS*. Set *RPL* for these devices to avoid damaging the transfer relay.

**Failure to follow these instructions can result in equipment damage.**

## Transitioning from Grid Mode to Battery Mode

When the unit is operating in grid mode and shore power is lost, the Freedom X has less than 20 milliseconds (default) to switch to operating in battery mode (if the Power button is pressed in the On position) and starts drawing power from the battery.

The operating mode indicator will change to Battery Mode and the green Status LED for Battery Mode will light up.

However, if the Power button is in Standby mode, this transition does not happen and the display panel turns off.

## **Transitioning from Battery Mode to Grid Mode**

When the unit is operating in Battery Mode and shore power becomes available, the Freedom X begins a 20-second countdown to verify the stability of the shore power. If shore power remains stable for a 20-second countdown, at the end of the countdown, the Freedom X will switch to shore power mode within 20 milliseconds and start drawing power from the AC source.

The operating mode indicator will change to grid mode and the green Status LED for grid mode will light up.

## Operating Limits

These are the operating limits of the Freedom X:

- *Power Output*
- *Input Voltage*
- *Overload Conditions*
- *High Surge Loads*
- *Over-temperature Conditions*

## Power Output

The Freedom X can deliver up to:

- 1000 watts (Freedom X 1000 120VAC 12VDC) or
- 2000 watts (Freedom X 2000 120VAC 12VDC or 24VDC as applicable) or
- 3000 watts (Freedom X 3000 120VAC 12VDC)

of continuous utility grade sine wave AC power. The wattage rating applies to resistive loads such as incandescent lights.

## Input Voltage

The allowable Freedom X input battery voltage ranges are shown in the following table:

Table 11 Input battery voltage range

Operating Condition	Battery Voltage	Comment
Full Operating Range	LBCO – 18.0 volts (12VDC models) LBCO – 32.0 volts (24VDC model)	Assuming the battery is full, the inverter will operate until battery voltage goes past below LBCO <sup>c</sup> and LBCO Shutdown delay timer <sup>d</sup> .
Low Voltage Recovery	< LBCO+0.2 volts	Inverter is able to recover and continue to operate.

<sup>c</sup>To set LBCO, see *Adjusting Feature Settings in Configuration Mode* on page 51.

<sup>d</sup>To set LBCO Shutdown Delay Timer, see *Input Voltage* on page 62.

Operating Condition	Battery Voltage	Comment
Low Voltage Shutdown	< LBCO	The buzzer sounds a single one-second low battery alarm beep and the LCD screen shows error code E0 1. After LBCO Shutdown delay timer runs out, the unit shuts down inverter output. The buzzer stops beeping and the LCD screen shows error code E0 1.
Instant Low Voltage Shutdown	< 9.0 volts	After two seconds below the limit, the unit shuts down inverter output completely. LCD screen turns off completely.

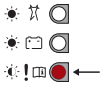
Operating Condition	Battery Voltage	Comment
High Voltage Shutdown	18.0 volts (12VDC models) 32.0 volts (24VDC model)	<p>The display shows error code <i>E02</i> alternating with the battery voltage. The red status LED turns on.</p>  <p><b>NOTE:</b> Although the Freedom X incorporates over-voltage protection, it can still be damaged if input voltage exceeds 18.0 (or 32.0) volts.</p>

## Overload Conditions

There are two kinds of overload conditions – an overload warning and an overload shutdown.

**Overload Warning** When the Freedom X’s AC load is approximately 100 W below the overload shutdown limit of rated watts, the audible alarm beeps once and the LCD screen shows a error code *E05*.

**Overload Shutdown** When the Freedom X’s AC load increases to near ~1100 W (Freedom X 1000 120VAC 12VDC) ~2100 W (Freedom X 2000 120VAC 12VDC or 24VDC as applicable) and ~3100 W (Freedom X 3000 120VAC 12VDC), the audible alarm beeps every five seconds for one minute and the LCD screen shows a error code *E03*. The Status LED turns solid RED.

## High Surge Loads

Some induction motors used in freezers, pumps, and other motor-operated equipment require high surge currents to start. The Freedom X may not be able to start some of these motors even though their rated steady state current draw is within the inverter’s limits. The unit will shut down and indicate an overload shutdown.

## Over-temperature Conditions

During inverter operation, when the Freedom X's internal temperature starts to approach its preset shutdown limit, the display will show error code `E07`. If the over-temperature condition persists, the display will show error code `E04`. The Status LED turns solid RED and the inverter will shut down to prevent damage to the inverter and protect the battery from being over-discharged.

## 5 ROUTINE MAINTENANCE

Regular maintenance is required to keep your Freedom X operating properly.

This section includes:

**Freedom X Unit** ..... **66**

# Freedom X Unit

## **WARNING**

### **ELECTRICAL SHOCK HAZARD**

Turning the Power button to Standby mode does not disconnect DC battery power from the Freedom X. You must disconnect from all power sources before working on any circuits connected to the unit.

**Failure to follow these instructions can result in death, serious injury, or equipment damage.**

Periodically you should:

- With all sources of power off, clean the exterior of the unit with a damp cloth to prevent the accumulation of dust and dirt.
- Ensure that the DC cables are secure and fasteners are tight.
- Make sure the ventilation openings are not clogged.



## 6 TROUBLESHOOTING

This section will help you narrow down the source of any problem you encounter. Before contacting customer service, please work through the steps listed in *Pre-service Checklist on page 68*.

This section includes:

<b>Pre-service Checklist</b> .....	<b>68</b>
<b>Warning Messages</b> .....	<b>69</b>
<b>Troubleshooting Reference</b> .....	<b>72</b>

## Pre-service Checklist

### **WARNING**

#### **ELECTRICAL SHOCK HAZARD**

Do not disassemble the Freedom X. It does not contain any user-serviceable parts. Attempting to service the unit yourself could result in an electrical shock or burn.

**Failure to follow these instructions can result in death, serious injury, or equipment damage.**

**NOTE:** To obtain service go to *Contact Information on page ii*.

Prior to obtaining service, see below:

1. Check for any error codes displayed on the LCD screen. If a message is displayed, record it before doing anything further.
2. As soon as possible, record the conditions at the time the problem occurred so you can provide details when you contact customer service for help. Include the following information:
  - What loads the Freedom X was running or attempting to run
  - What the battery condition was at the time (voltage, etc.) if known
  - Recent sequence of events
  - Any known unusual AC shore power factors such as low voltage, unstable generator output, etc.

- Whether any extreme ambient conditions existed at the time (temperature, vibrations, moisture, etc.)
3. If your Freedom X is not displaying an error code, check the following to make sure the present state of the installation allows proper operation:
    - Is the inverter located in a clean, dry, adequately ventilated place?
    - Are the battery cables adequately sized as recommended in the Installation guide?
    - Is the battery in good condition?
    - Are all DC connections tight?
    - Are the AC input and output connections and wiring in good condition?
    - Are the configuration settings correct for your particular installation?
    - Are all disconnects and AC breakers closed and operable?
    - Have any of the fuses blown in the installation?
  4. Contact customer support for further assistance. Please be prepared to describe details of your system installation and to provide the model and serial number of the unit.

## Warning Messages

Warning messages in the form of audible alarms and error codes that appear on the LCD screen to alert you to an impending system change. Warnings do not affect operation.

With the exception of the error codes displayed on the screen, only the audible alarm can be turned ON or OFF. Follow the steps in *Turning the Audible Alarm ON or OFF on page 58* to change the alarm settings.

The error codes are listed in *Table 12*. The text in the **Error Code** column appears on the LCD screen of the display panel.

Table 12 Error codes displayed on the LCD screen

Error Code	Condition	Mode	Action
E01	Low battery voltage shutdown is imminent depending on the setting, see <i>Freedom X Unit on page 66</i> .	Battery mode (inverting)	Check battery status and recharge if necessary. Check for proper DC cable sizing. Check for loose connections and tighten if necessary.
E02	High battery voltage shutdown > 18.0 volts DC (12VDC models) and > 32.0 volts DC (24VDC model)	Battery mode (inverting)	Check for external charging sources, such as a PV charger and an over voltage alternator. Disconnect, if necessary.
E03	AC output overload shutdown	Battery mode (inverting)	Reduce the loads connected to the AC outlet of the unit. Check appliances that have high-surge ratings and disconnect if necessary.
E04	Over-temperature shutdown	Battery mode (inverting)	Reduce the loads connected to the AC outlet of the unit. Check that the ventilation grille is not blocked. Check for ambient temperature and move the unit to a cooler location whenever possible.
E05	AC output overload warning	Battery mode (inverting)	Reduce the loads connected to the AC outlet of the unit.

Error Code	Condition	Mode	Action
E07	Over-temperature alarm and fan lock alarm	Battery mode (inverting)	<p>Reduce the loads connected to the AC outlet of the unit.</p> <p>Check that the ventilation grille is not blocked.</p> <p>Check for ambient temperature and move the unit to a cooler location whenever possible.</p> <p>Check the fan for any obstruction and remove it.</p>
E08	Fan lock error	Grid mode (bypass)	<p>If there is no issue with the fan, disconnect the unit from its DC and AC power sources, then reconnect, and then restart the unit. Perform <i>Drip Shield Installation on page 42</i>.</p> <p>If error detection persists, contact customer service.</p>
E 10 to E 19	Internal hardware error	Battery and grid modes	<p>If error detection persists, contact customer service.</p>

For error code E07, after the LBCO shutdown delay, the unit will immediately stop inverting.

For error codes E02 to E04, the unit will stop inverting.

## Troubleshooting Reference

### **WARNING**

#### **ELECTRICAL SHOCK HAZARD**

Do not disassemble the Freedom X. It does not contain any user-serviceable parts. Attempting to service the unit yourself could result in an electrical shock or burn.

**Failure to follow these instructions can result in death, serious injury, or equipment damage.**

### ***NOTICE***

#### **INVERTER DAMAGE**

Avoid continually overloading the inverter and subjecting it to over temperature conditions. Although provided with integral protection against overloads continual overloading can damage the circuitry.

**Failure to follow these instructions can result in damage to the inverter.**

Table 13 Troubleshooting reference

Problem	Possible Cause	Solution
Alarm does not sound when an error is encountered.	Alarm is turned OFF.	See <i>Freedom X Unit on page 66</i> and follow instructions to turn the alarm buzzer on again.
No output voltage. The status LED is red.	AC shore power is not available or out of operating range and the inverter has shut down with the LCD screen showing one of the following error codes:	
	High input voltage (error code E02)	Verify the unit is connected to a 12V (or 24V as applicable) battery. Check the voltage regulation of the external charging system (if any).
	Unit overload or AC output short circuit (error code E03)	Reduce the load. Make sure the load does not exceed the output rating.
	Thermal shutdown (error code E04)	Allow the unit to cool off. Reduce the load if continuous operation is required. Improve ventilation. Make sure the inverter's ventilation openings are not blocked.

Problem	Possible Cause	Solution
<p>No output voltage is shown in the LCD screen but the green status LED for Battery mode is illuminated.</p>	<p>GFCI (when installed) has tripped or supplementary breaker has tripped.</p>	<p>Check load and reset the GFCI or supplementary breaker.</p>
	<p>Circuit breaker on the AC load panel or AC output disconnect has tripped.</p>	<p>Reset the circuit breaker or check the AC output disconnect circuits.</p>
	<p>Battery voltage is too low (depending on setting, see <i>Freedom X Unit on page 66</i>) to start inverting. LCD screen may show DC voltage as 000.</p>	<p>Check DC connections and cable. Recharge battery.</p>
<p>No output voltage is shown in the LCD screen and neither of the green status LEDs (for Grid mode and Battery mode) is illuminated.</p>	<p>AC shore power is not available or out of operating range and the inverter is OFF.</p>	<p>Check AC shore power. Turn the inverter ON.</p>
	<p>AC shore power is not available and the inverter is OFF due to a shutdown for more than 30 seconds.</p>	<p>Check AC shore power and battery voltage. Turn the inverter ON and look at the LCD screen for any error code. See <i>"Problem" on the previous page</i>.</p>
<p>No output voltage. The status LED is not lighting up.</p>	<p>Ignition lock (ACC) signal is not present.</p>	<p>If the ignition control feature is in use, ensure the vehicle's ignition is On and the ignition control switch on the front of the Freedom X unit is On (I).</p>



<b>Problem</b>	<b>Possible Cause</b>	<b>Solution</b>
The fan turns on and off during AC shore power mode.	The battery is discharged. AC pass-through current is high.	Do not be alarmed, the unit is performing normally.
The fan turns on and off during inverter mode.	The inverter is running continuously at high power.	Do not be alarmed, the unit is performing normally. The fan is activated automatically.

## Inverter Applications

The Freedom X performs differently depending on the AC loads connected to it. If you are having problems with any of your loads, read this section.

### Resistive Loads

These are the loads that the inverter finds the simplest and most efficient to drive. Voltage and current are in phase (that is, in step with one another). Resistive loads usually generate heat in order to accomplish their tasks. Toasters, coffee pots, and incandescent lights are typical resistive loads. It is usually impractical to run larger resistive loads—such as electric stoves and water heaters—from an inverter due to their high current requirements. Even though the inverter can most likely accommodate the load, the size of battery bank required would be impractical if the load is to be run for long periods.

### Motor Loads

Induction motors (that is, motors without brushes) require two to six times their running current on start up. The most demanding are those that start under load, for example, compressors and pumps. Of the capacitor start motors (typical in drill presses, band saws, etc.), the largest you can expect to run is ½ hp (the transfer relays are rated at 2 hp). Universal motors are generally easier to start. Since motor characteristics vary, only testing will determine whether a specific load can be started and how long it can be run. If a motor fails to start within a few seconds or loses power after running for a time, it should be turned off. When the inverter attempts to start a load that is greater than it can handle, it will turn itself off after a few seconds.

### Long Transfer Times

The Freedom X may take a long time (~ 0.1–0.2 seconds) to transfer to Battery Mode when shore power is cut off while powering a motor load. Motor loads typically “freewheel” when power is removed (for example, a grinder) and causes a longer transfer time. The longer transition from shore power to inverter power may cause connected computers or other sensitive equipment to operate incorrectly. To avoid this effect, do not connect motor loads together with sensitive equipment to the inverter for power.

## 7 SPECIFICATIONS

This section summarizes the hardware and electrical specifications of the Freedom X Inverter.

This section includes:

<b>Physical Specifications</b> .....	<b>78</b>
<b>Environmental Specifications</b> .....	<b>79</b>
<b>System Specifications</b> .....	<b>80</b>
<b>Regulatory Approvals</b> .....	<b>83</b>

**NOTE:** Specifications are subject to change without prior notice.

# Physical Specifications

Table 14 Physical specifications

	Freedom X 1000 120VAC 12VDC	Freedom X 2000 (Both 12 & 24VDC models)	Freedom X 3000 120VAC 12VDC
L x W x H	13.4" x 9.1" x 3.7" (340mm x 232mm x 95mm)	14.6" x 10.8" x 3.9" (370mm x 275mm x 100mm)	15.4" x 10.8" x 4.0" (390mm x 275mm x 102mm)
	<b>NOTE:</b> Width does not include flanges.	<b>NOTE:</b> Width does not include flanges.	<b>NOTE:</b> Width does not include flanges.
Net Weight	11.2 lbs (5.1 kg)	15.9 lbs (7.2 kg)	16.5 lbs (7.5 kg)

Table 15 Product dimensions

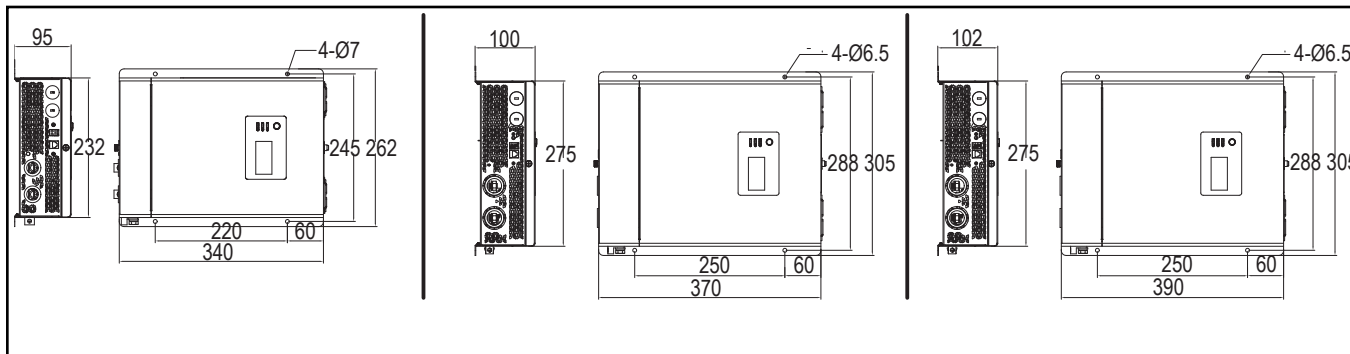

# Environmental Specifications

Table 16 Environmental specifications

	Freedom X 1000 120VAC 12VDC	Freedom X 2000 (Both 12 & 24VDC models)	Freedom X 3000 120VAC 12VDC
Ambient Temperature:			
Operating Temperature Range <sup>a</sup>	-4 –140 °F (-20 –60 °C), with output derated above 104 °F (40 °C)		
Storage Temperature Range	-40 –158 °F (-40 –70 °C)		
Humidity: Operation/Storage	5–95% RH, non-condensing		

<sup>a</sup>Operation may be limited based on the battery chemistry. For example, Lithium Iron Phosphate batteries have a limited charging temperature range. Follow specific battery manufacturer recommendations for the applicable chemistry.

# System Specifications

Table 17 System specifications

	Freedom X 1000 120VAC 12VDC	Freedom X 2000 (Both 12 & 24VDC models)	Freedom X 3000 120VAC 12VDC
Transfer relay rating (A <sup>a</sup> )	30A	30A	30A
Transfer time (milliseconds <sup>b</sup> )			
Shore to inverter: Inverter to shore:	<20 milliseconds <20 milliseconds with a 20-second delay	<20 milliseconds <20 milliseconds with a 20-second delay	<20 milliseconds <20 milliseconds with a 20-second delay
Transfer voltage (V)			
Shore to inverter: Inverter to shore:	<85 V and >140 V <135 V and >90 V	<85 V and >140 V <135 V and >90 V	<85 V and >140 V <135 V and >90 V
Cooling	Fan, activated by any of the following: High internal temperature High AC output power	Fan, activated by any of the following: High internal temperature High AC output power	Fan, activated by any of the following: High internal temperature High AC output power

<sup>a</sup>Circuit breakers shall not carry more than 80% of their UL rating continuously.

<sup>b</sup>To change the AC Transfer time (mode), see *Freedom X Unit* on page 66.

Table 18 DC input for inverting

	<b>Freedom X 1000 120VAC 12VDC</b>	<b>Freedom X 2000 (Both 12 &amp; 24VDC models)</b>	<b>Freedom X 3000 120VAC 12VDC</b>
Operating voltage range	LBCO voltage <sup>a</sup> –18.0 VDC	LBCO voltage <sup>b</sup> –18.0 VDC	LBCO voltage <sup>c</sup> –18.0 VDC
Maximum non-operating voltage	24 VDC	25.2 VDC (12VDC models) 50.4 VDC (24VDC models)	25.2 VDC
Nominal voltage	12.0 VDC	12.0 VDC (12VDC models) 24.0 VDC (24VDC model)	12.0 VDC
Nominal current at full load	100 ADC	192 ADC (12VDC models) 96 ADC (24VDC model)	288 ADC

<sup>a</sup>To set LBCO, see *Adjusting Feature Settings in Configuration Mode* on page 51.

<sup>b</sup>To set LBCO, see *Adjusting Feature Settings in Configuration Mode* on page 51.

<sup>c</sup>To set LBCO, see *Adjusting Feature Settings in Configuration Mode* on page 51.

Table 19 AC output for inverting

	<b>Freedom X 1000 120VAC 12VDC</b>	<b>Freedom X 2000 (Both 12 &amp; 24VDC models)</b>	<b>Freedom X 3000 120VAC 12VDC</b>
Output voltage options	120, 110, 108 VAC	120, 110, 108 VAC	120, 110, 108 VAC
Continuous power (W <sup>d</sup> )	1000 W @ 40 °C	2000 W @ 40 °C	3000 W @ 40 °C
Continuous current	8.4 A	16.7 A	25 A
Surge power (5 sec)	2000 W	4000 W	6000 W
Frequency <sup>e</sup>	60 (or 50) Hz	60 (or 50) Hz	60 (or 50) Hz
Wave shape	True Sine Wave	True Sine Wave	True Sine Wave
Peak efficiency	91%	91% (12 VDC models) 92.4% (24 VDC model)	91%
Full load efficiency	≥ 87%	≥ 87.5% (12 VDC models) ≥ 90.9% (24 VDC model)	≥ 85%

<sup>d</sup>Power derates to 85% when output voltage is set to 110/108 VAC.

<sup>e</sup>To set the AC Frequency, see *Freedom X Unit on page 66*.



# Regulatory Approvals

Table 20 Regulatory approvals

	<b>Freedom X 1000 120VAC 12VDC</b>	<b>Freedom X 2000 (Both 12 &amp; 24VDC models)</b>	<b>Freedom X 3000 120VAC 12VDC</b>
Safety	ETL-listed complies to CSA 107.1 UL458 and UL458 Marine Supplement (drip shield with product number 808-1050 required) ABYC E-11, A-31, A-32	ETL-listed complies to CSA 107.1 UL458 and UL458 Marine Supplement (drip shield with product number 808-1050 required) ABYC E-11, A-31, A-32	ETL-listed complies to CSA 107.1 UL458 and UL458 Marine Supplement (drip shield with product number 808-1050 required) ABYC E-11, A-31, A-32
EMC	47 CFR Subpart B, Part 15, Class B CAN ICES-3(B)/NMB-3(B)	47 CFR Subpart B, Part 15, Class B CAN ICES-3(B)/NMB-3(B)	47 CFR Subpart B, Part 15, Class B CAN ICES-3(B)/NMB-3(B)

# xantrex™

A MISSION CRITICAL ELECTRONICS BRAND

Smart choice for power™

<http://www.xantrex.com/>

(Toll Free USA/Canada) +1 800 670 0707

(Outside USA/Canada) +1 408 987 6030

975-0787-01-01 Rev F

Printed in: