

## FREEDOM X 1200 INVERTER DATASHEET

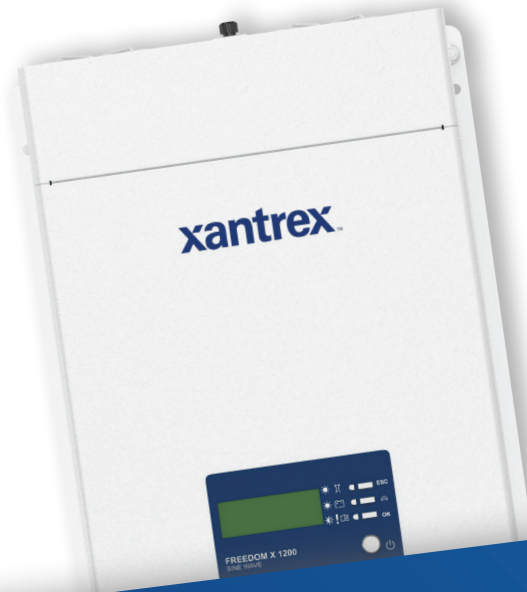

AVAILABLE IN:  
12 V<sub>DC</sub>  
**1200 W**

### ROBUST. DURABLE. FLEXIBLE.

Engineered specifically to meet the needs of heavy duty trucks, the FREEDOM X 1200 offers a perfect blend of performance and cost. The FREEDOM X 1200 is ideal for installation in all types of commercial vehicles.

Its rugged, industrial design ensures optimum performance in all conditions. Quick connect terminals at AC input & output and pre-wired pigtail cables enable fast and easy installation on the assembly line. Conformal-coated circuit boards and heavy duty metal casing make the FREEDOM X 1200 ideal for mobile applications. It also features true sine wave output, 2X continuous power surge rating, built-in transfer switch and low battery voltage shutdown among other features.

The FREEDOM X 1200 Pro has built-in communication card for integration with third-party monitoring and control display panels through RV-C connectivity.

 Back-up capability with exceptionally fast transfer time

 Overload and over temperature alarm and shutdown

 Minimum battery drain

 Built-in RV-C communications protocol<sup>1</sup>

#### APPLICATIONS:



ETL listed to CSA Standard C22.2 No. 107.1 and UL 458\* with Marine supplement

\*For marine supplement compliance drip shield in specific mounting orientation is required. See installation guide.

**2 YEAR  
WARRANTY**



FRONT VIEW

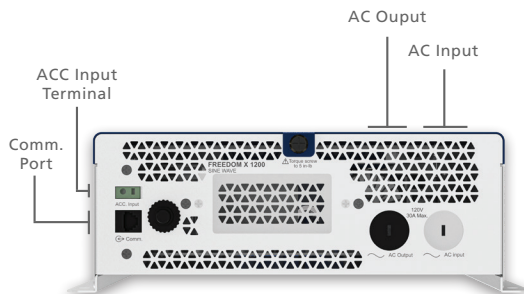

BOTTOM VIEW

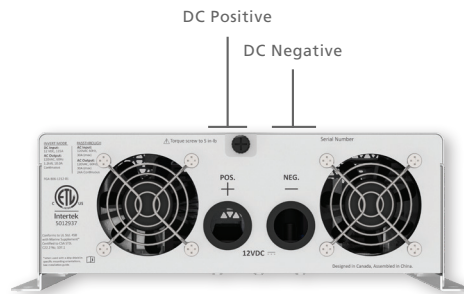

TOP VIEW

## INVERTER FEATURES

### Extended Surge Rating

- Surges to 2X continuous power for at least 2 seconds for motor loads

### True Sine Wave AC Power

- For operation of sensitive and motor loads

### Wide 10–16.5 VDC Input Range

- Ensures inverter operation on high voltage alternators found on many new vehicle chassis

### Built in 30 A AC Transfer Relay

- Senses when outside AC Power is present and transfers the load from the inverter to the source of incoming power

### Ignition Control

- Feature to turn inverter on/off via a 12 VDC signal and to minimize battery drain by switching the inverter off when the ignition key is turned off

## RECOMMENDED POWER SOLUTIONS

COMPLETE YOUR ELECTRICAL SYSTEM



FREEDOM X COMBOX  
808-0822



XANTREX 12 V 105 Ah  
LITHIUM-ION BATTERY  
883-0105-12



XANTREX 12 V 125 Ah  
LITHIUM-ION BATTERY  
883-0125-12



XANTREX 12 V 240 Ah  
LITHIUM-ION BATTERY  
883-0240-12

## ELECTRICAL SPECIFICATIONS

	FREEDOM X 1200	FREEDOM X 1200 Pro
Output Power (Continuous)	1200 W	1200 W
Surge Rating	2400 W	2400 W
Output Voltage Range	110–125 Vac	110–125 Vac
Output Frequency Regulation (user configurable)	50 / 60 Hz	50 / 60 Hz
Output Wave Form	True sine wave	True sine wave
Efficiency (full load)	> 86%	> 86%
Peak Efficiency	> 91%	> 91%
No-Load Input Power (producing output voltage)	< 10 W	< 10 W
Off Mode Current Draw (display off)	< 4 mA	< 4 mA
AC Input Operating Voltage Range	95–130 Vac	95–130 Vac
AC Transfer Relay	30 A	30 A
DC Input Operating Voltage Range	10.5–16.5 Vdc	10.5–16.5 Vdc
Transfer Time	10–20 ms	10–20 ms
Battery Voltage (Nominal)	12 Vdc	12 Vdc
Low Battery Cut-Out	Adjustable from 10.5–12.1 Vdc	Adjustable from 10.5–12.1 Vdc
AC Receptables	15 A breaker supplied. Optional customer supplied GFCI	N/A

## GENERAL SPECIFICATIONS

	FREEDOM X 1200	FREEDOM X 1200 Pro
Operating Temperature Range	-4–122°F (-20–50°C)	-4–122°F (-20–50°C)
Storage Temperature Range	-40–158°F (-40–70°C)	-40–158°F (-40–70°C)
Transfer Relay AC Current Rating	30 A	30 A
Operating Humidity Range	5–95%, non-condensing	5–95%, non-condensing
Part Number	806-1212	806-1212-05
Dimensions (L x W x H)	14.8 x 10.4 x 3.5" (376 x 263 x 91 mm)	14.8 x 10.4 x 3.5" (376 x 263 x 91 mm)
Net Weight	10.4 lb (4.7 kg)	10.4 lb (4.7 kg)

## REGULATORY AND ENVIRONMENTAL COMPLIANCE

	FREEDOM X 1200 & FREEDOM X 1200 Pro
ETL	ETL listed to CSA Standard C22.2 No. 107.1, UL458 with marine supplement <sup>1</sup>
FCC	FCC Part 15, Class B

<sup>1</sup>When used with drip shield, part #808-1050

## FREEDOM X 1200 & FREEDOM X 1200 PRO DIMENSIONS

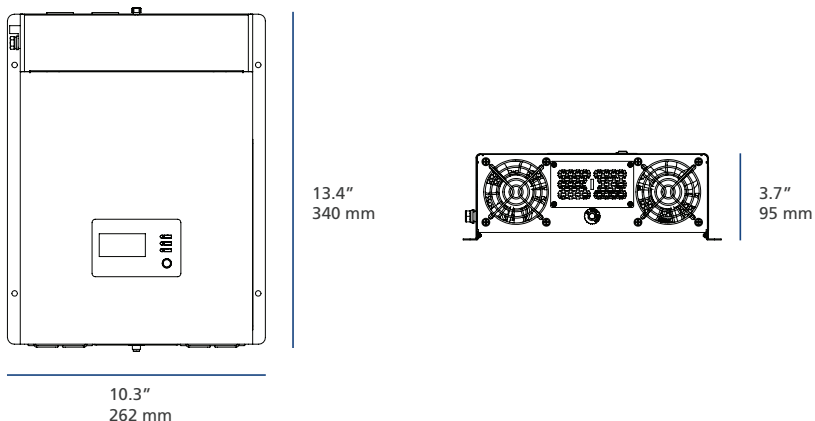

## ACCESSORIES

Mfg Part #	Description
808-0820	Communications and Control (20 pin) (FREEDOM X 1200 PRO only)
808-1050	Drip Shield (for marine use)

