

Product data sheet

Specifications

SQUARE D

Green Premium™



Mini circuit breaker, Homeline, 50A, 2 pole, 120/240VAC, 10kA AIR, standard type, plug in, UL

HOM250

Main

Product	Miniature circuit-breaker
Range	Homeline
Current Rating	50 A
Certifications	UL Listed
Voltage Rating	120/240 V AC
Mounting Type	Plug-in
Number of Poles	2P
Short Circuit Current Rating	10 kA
Number of Spaces	2
Circuit Breaker Type	Standard
Ratings	HACR rated
Electrical Connection	Box lugs
Wire Size	AWG 8...AWG 2 aluminium/copper)1

Complementary

Tightening torque	40.71 lbf.in (4.6 N.m) (AWG 8...AWG 2)
Height	3.13 in (79.50 mm)
Width	2 in (50.80 mm)
Depth	2.98 in (75.69 mm)

Environment

Ambient Air Temperature for Operation	104 °F (40 °C)
---------------------------------------	----------------

Ordering and shipping details

Category	00046-HOM/T 15-30A 1P; 15-60A 2P
Discount Schedule	DE3D
GTIN	785901065326
Nbr. of units in pkg.	1

* Price is "List Price" and may be subject to a trade discount – check with your local distributor or retailer for actual price.

Package weight(Lbs)	11.22 oz (318.0 g)
Returnability	Yes
Country of origin	MX

Packing Units

Unit Type of Package 1	PCE
Package 1 Height	2.00 in (5.08 cm)
Package 1 width	3.00 in (7.62 cm)
Package 1 Length	3.20 in (8.128 cm)
Unit Type of Package 2	PAL
Number of Units in Package 2	1800
Package 2 Weight	1315.00 lb(US) (596.473 kg)
Package 2 Height	40.00 in (101.6 cm)
Package 2 width	40.00 in (101.6 cm)
Package 2 Length	48.00 in (121.92 cm)
Unit Type of Package 3	BB1
Number of Units in Package 3	5
Package 3 Weight	3.65 lb(US) (1.656 kg)
Package 3 Height	3.00 in (7.62 cm)
Package 3 width	2.60 in (6.604 cm)
Package 3 Length	10.10 in (25.654 cm)

Offer Sustainability

Sustainable offer status	Green Premium product
REACH Regulation	REACH Declaration
REACH free of SVHC	Yes
EU RoHS Directive	Compliant EU RoHS Declaration
Toxic heavy metal free	Yes
Mercury free	Yes
RoHS exemption information	Yes
China RoHS Regulation	China RoHS declaration Pro-active China RoHS declaration (out of China RoHS legal scope)
Environmental Disclosure	Product Environmental Profile

Contractual warranty

Warranty	Lifetime
----------	----------

Dimensions

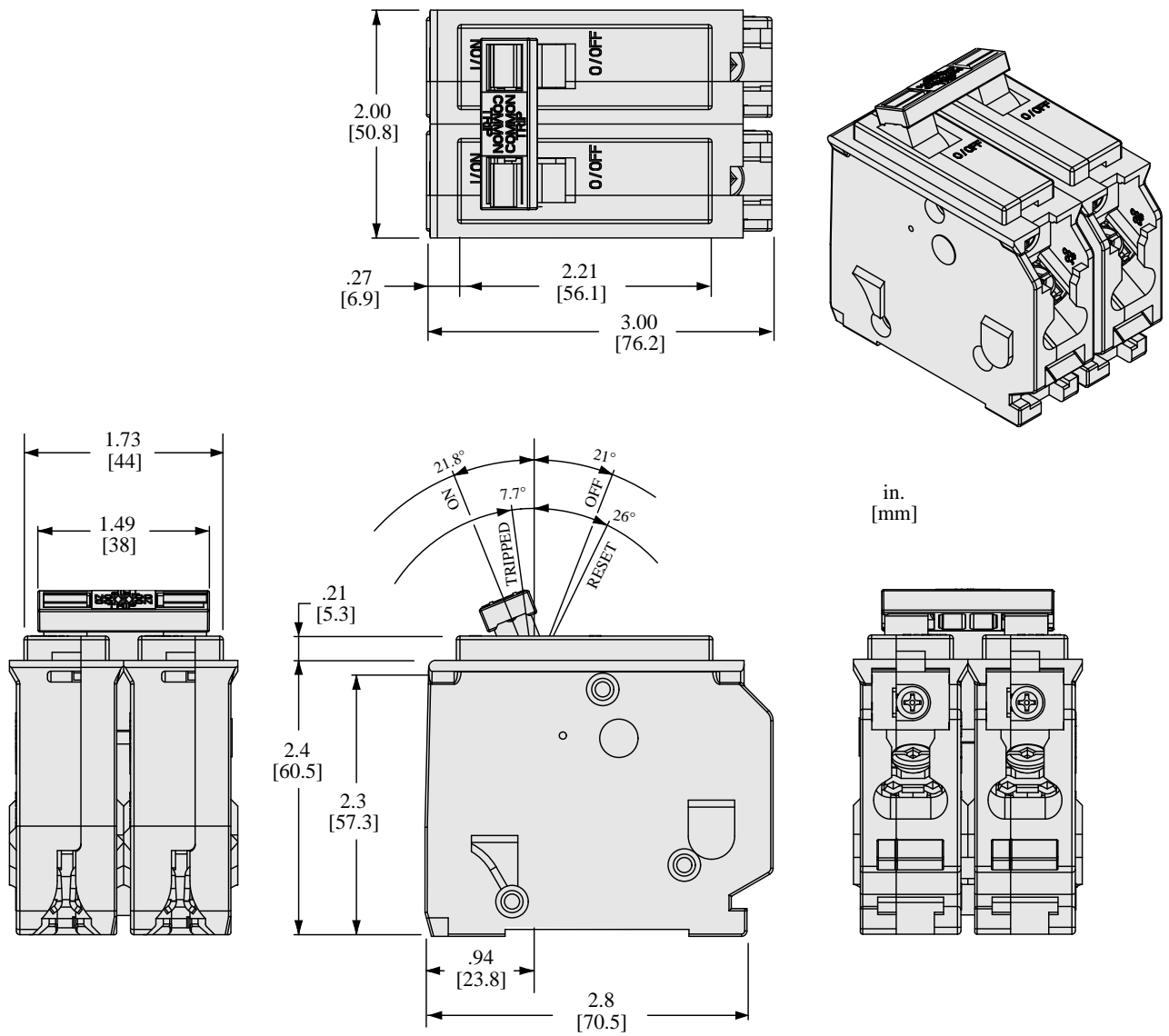

All dimensions are approximate. Also refer to technical drawings and documentation.