



samlexpower®

**Solar
Charge
Controller**

MSK-20A

**Owner's
Manual**

Please read this
manual **BEFORE**
using your
Charge
Controller

OWNER'S MANUAL | Index

SECTION 1

Safety Instructions	3
---------------------------	---

SECTION 2

General Information, Features & Layout	5
--	---

SECTION 3

Installation	7
--------------------	---

SECTION 4

Operation	13
-----------------	----

SECTION 5

Protections & Troubleshooting	18
-------------------------------------	----

SECTION 6

Specifications	23
----------------------	----

SECTION 7

Warranty	25
----------------	----

Disclaimer of Liability

UNLESS SPECIFICALLY AGREED TO IN WRITING, SAMLEX AMERICA INC.:

1. MAKES NO WARRANTY AS TO THE ACCURACY, SUFFICIENCY OR SUITABILITY OF ANY TECHNICAL OR OTHER INFORMATION PROVIDED IN ITS MANUALS OR OTHER DOCUMENTATION.
2. ASSUMES NO RESPONSIBILITY OR LIABILITY FOR LOSSES, DAMAGES, COSTS OR EXPENSES, WHETHER SPECIAL, DIRECT, INDIRECT, CONSEQUENTIAL OR INCIDENTAL, WHICH MIGHT ARISE OUT OF THE USE OF SUCH INFORMATION. THE USE OF ANY SUCH INFORMATION WILL BE ENTIRELY AT THE USERS RISK.

Samlex America reserves the right to revise this document and to periodically make changes to the content hereof without obligation or organization of such revisions or changes.

Copyright Notice/Notice of Copyright

Copyright © 2021 by Samlex America Inc. All rights reserved. Permission to copy, distribute and /or modify this document is prohibited without express written permission by Samlex America Inc.

SECTION 1 | Safety Instructions

IMPORTANT SAFETY INSTRUCTIONS

PLEASE READ THE FOLLOWING SAFETY INSTRUCTIONS BEFORE USING THE CHARGE CONTROLLER. FAILURE TO ABIDE BY THE RECOMMENDATIONS MAY CAUSE PERSONAL INJURY / DAMAGE TO THE CONTROLLER.

The following safety symbols will be used in this manual to highlight safety and information:



WARNING!

Indicates possibility of physical harm to the user in case of non-compliance.



CAUTION!

Indicates possibility of damage to the equipment in case of non-compliance.



INFO

Indicates useful supplemental information.



WARNINGS



CAUTIONS!

1. This Charge Controller is not waterproof (*Ingress Protection Rating is IP-30*). PLEASE ENSURE THAT THE UNIT IS INSTALLED IN DRY, COOL AND WELL VENTILATED ENVIRONMENT.
2. Ground the Negative of the battery as follows:
 - to Earth Ground in shore installations
 - to Chassis Ground in Negative grounded mobile installations
3. There are no user serviceable parts inside the controller. Do not disassemble or attempt to repair it.
4. Install external fuses / breakers as required.
5. Disconnect the Solar Panel(s) and fuse / breakers near to battery before installing or adjusting the controller.
6. Confirm that power connections are tightened to avoid excessive heating from loose connection.
7. The charge controller has been factory preset to optimally charge 12V / 24V Sealed Lead Acid Batteries (*AGM - Absorbed Glass Mat*)
8. Comply with battery manufacturer's recommendations.
9. Avoid charging damaged, defective or old battery.
10. Ensure correct polarity is maintained when connecting the Charge Controller to the battery - Connect the Positive output terminal to the Positive Battery Post and the Negative output terminal to the Negative Battery Post.
11. When charging, removal of the battery from the vehicle is not necessary provided the battery is being charged in a well-ventilated area.
12. Batteries contain very corrosive diluted Sulphuric Acid as electrolyte. Precautions should be taken to prevent contact with skin, eyes or clothing. If battery electrolyte makes contact with skin or clothing, flush immediately with water. See a doctor immediately.

SECTION 1 | Safety Instructions

13. Batteries generate Hydrogen and Oxygen during charging resulting in evolution of explosive gas mixture in non-sealed batteries. Care should be taken to ventilate the battery area when non-sealed batteries are used and follow battery manufacturer's recommendations.
14. Ensure there are no flammable substances, explosive gases, flames, smoke or spark near the battery or the Solar Panel(s).
15. Use caution to reduce the risk of dropping a metal tool on the battery. It could spark or short circuit the battery or other electrical parts and could cause an explosion.
16. Remove metal items like rings, bracelets and watches when working with batteries. Batteries can produce a short circuit current high enough to weld a ring or the like to metal and thus, cause a severe burn.
17. If you need to remove a battery, always remove the Negative (Ground) connection from the battery first. Make sure that all the accessories are off so that you do not cause a spark.
18. Solar Panel(s) generate electrical power when exposed to sunlight. Place a dark cover over the panels when handling panels that have bare, un-insulated output wires. Accidental shorting of panel terminals or wiring connected to the panels can result in spark causing personal injury or a fire hazard.
19. It is important that the battery gets fully charged frequently (*at least once per week*). Otherwise, the battery can become permanently damaged due to under charging. Partially charged batteries can quickly sulfate internally which is an irreversible condition. It is good practice to prevent a battery from being discharged below 50%. Deeper discharging severely shortens battery life.
20. Keep the surface of Solar Panel(s) clean from dust / dirt / leaves / other debris. Clean with a soft wet cloth (*to prevent scratching*). Do not walk on the panels.
21. Installation and wiring must comply with the local and National Electrical Codes and must be done by a certified electrician.

SECTION 2 | General Information, Features & Layout

2.1 GENERAL INFORMATION

MSK-20A is a 20A rated, Series Type of PWM (*Pulse Width Modulation*) Charge Controller. It is based on an advanced design using a microcontroller for digital accuracy and fully automatic operation. It is designed to charge 12V / 24V Lead Acid Batteries..

2.2 FEATURES

- Advanced microcontroller based, high performance design for digital accuracy and fully automatic and intelligent operation
- Series Type PWM (*Pulse Width Modulation*) charging for low loss, higher efficiency charging and longer battery life
- Up to 50V Open Circuit Voltage (*Voc*) and up to 20A Short Circuit Current (*Isc*) of PV Panel(s)
- Dual voltage capability – can be used with 12V / 24V batteries. 12V / 24V Nominal Battery System is detected automatically: Battery voltage < 18V is detected as 12V battery and >18V is detected as 24V battery
- 3 stages of charging for 100% return of capacity and for longer battery life
 - Normal: Bulk Stage →Absorption Stage →Float Stage
- Factory preset for charging Sealed Lead Acid Batteries (*AGM - Absorbed Glass Mat*)
- User friendly LED display for monitoring of operation and self diagnostics for troubleshooting
- Built-in or optional Remote Battery Temperature Sensor (*Model MSK-TS*) for battery temperature compensation to ensure improved charging of batteries that experience wider temperature variations during the year
- MOSFET based reverse current blocking for night-time battery discharge prevention. This allows much lower losses as compared to Diode based blocking
- **Protections:** (i) Solar Panel over current (ii) Solar Panel short circuit (iii) Solar Panel reverse polarity (iv) Battery reverse polarity (v) Battery over voltage (vi) Controller / battery overtemperature (vii) Overload and short circuit protections on Load Terminals

2.3 APPLICATIONS

- Recreational / Service Vehicles
- Off grid
- Portable Charging Kits
- Boats and marine crafts
- Field work / mobile offices
- Telecommunications

SECTION 2 | General Information, Features & Layout

2.4 LAYOUT

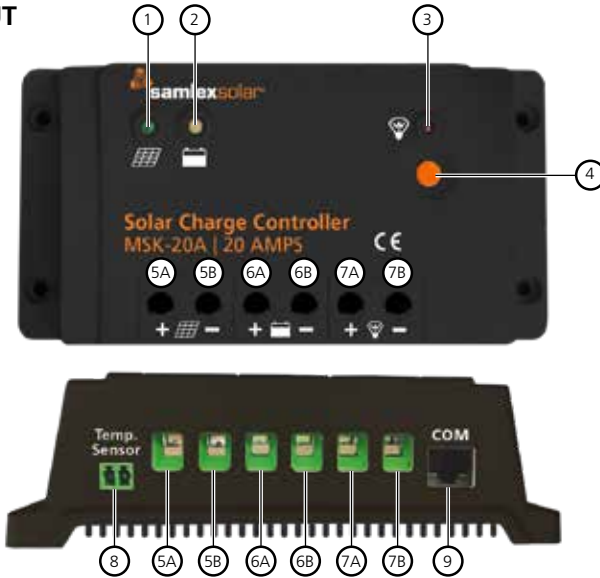

LEGEND FOR FIG 2.1			
Item No.	Description	Item No.	Description
①	Solar Panel Status LED	⑥A	Battery Terminal (+)
②	Battery Status LED	⑥B	Battery Terminal (-)
③	Load Status LED	⑦A	Load Terminal (+)
④	Load On/Off Button Also used for clearing load size overload and short circuit faults.	⑦B	Load Terminal (-)
⑤A	Solar Panel Input Terminal (+)	⑧	Connector for optional Remote Battery Temperature Sensor Model "MSK-TS" <i>(See NOTE 1)</i>
⑤B	Solar Panel Input Terminal (-)	⑨	RS-485 Communication Port (NOT USED)

NOTES: 1. If the Remote Battery Temperature Sensor is short-circuited or damaged, the controller will charge or discharge at the default temperature setting of 25°C.

2. All terminal can accept conductor size up to AWG#8 / 10mm²

Fig 2.1: Layout of Charge Controller MSK-20A

SECTION 3 | Installation

3.1 SAFETY



WARNING!



CAUTION!

PLEASE READ ALL THE SAFETY INSTRUCTIONS GIVEN IN SECTION 1 BEFORE INSTALLING AND OPERATING THE CONTROLLER. FAILURE TO ABIDE BY THE RECOMMENDATIONS MAY CAUSE PERSONAL INJURY / DAMAGE TO THE KIT.

DO NOT USE THE UNIT IN WET ENVIRONMENT

- Please note that this unit is not waterproof (*its Ingress Protection Rating is IP-30*). Ensure that the unit is installed in dry environment.

GROUNDING

- Ground the Negative terminal of the BATTERY (*6B in Fig 2.1*) to Earth Ground in shore installation and to the Chassis Ground in mobile installations.
- DO NOT GROUND THE SOLAR ARRAY Negative when battery negative is grounded.

BATTERY TYPES

- The unit has been factory preset to optimally charge 12/24V, Sealed (AGM) Lead Acid Batteries.



MISE EN GARDE!



ATTENTION!

VEUILLEZ LIRE TOUTES LES INSTRUCTIONS DE SÉCURITÉ DONNÉES DANS LA SECTION 1 AVANT D'INSTALLER ET D'UTILISER LE CONTRÔLEUR. NON-RESPECT DE LA LES RECOMMANDATIONS PEUVENT PROVOQUER DES BLESSURES OU ENDOMMAGER LE KIT.

N'UTILISEZ PAS L'APPAREIL DANS UN ENVIRONNEMENT HUMIDE

- Veuillez noter que cet appareil n'est pas étanche (*son indice de protection d'entrée est IP-30*). Par conséquent, veuillez vous assurer que l'unité est installée dans un environnement sec.

MISE À LA TERRE

- Mettez à la terre la borne négative de la batterie (*6B, Fig 2.1*) à la terre à la terre dans l'installation à terre et à la masse du châssis dans les installations mobiles à la terre négative.

TYPES DE BATTERIE

- L'unité a été pré-réglée en usine pour charger de manière optimale les batteries au plomb-acide scellées (AGM) 12 / 24V.

SECTION 3 | Installation

3.2 DIMENSIONAL DRAWING

Dimensional drawing is given at Fig 3.1 below:

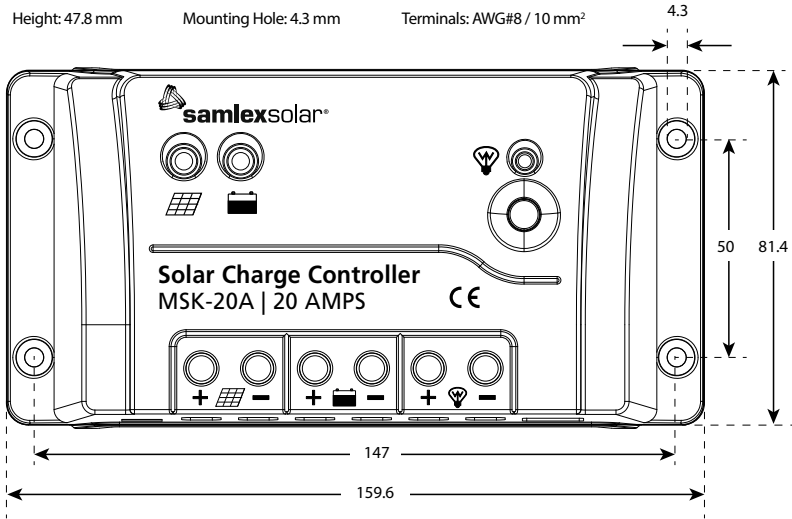

Fig 3.1: Dimensional Drawing of Charge Controller MSK-20A

3.3 MOUNTING

Refer to Fig 3.1

When mounting the controller, ensure free air through the ventilation slots at the bottom of the unit. There should be at least 6 inches (150 mm) of clearance above and below the controller to allow for cooling. If mounted in an enclosure, forced air ventilation is highly recommended.



WARNING!

RISK OF EXPLOSION! NEVER INSTALL THE CONTROLLER IN A SEALED ENCLOSURE WITH FLOODED BATTERIES! DO NOT INSTALL IN A CONFINED AREA WHERE BATTERY GASSES CAN ACCUMULATE.



MISE EN GARDE!

RISQUE D'EXPLOSION! N'INSTALLEZ JAMAIS LE CONTRÔLEUR DANS UN BOÎTIER SCELLÉ AVEC DES BATTERIES INONDÉES! NE PAS INSTALLER DANS UNE ZONE CONFINÉE OÙ DES GAZ DE BATTERIE PEUVENT S'ACCUMULER.

SECTION 3 | Installation

3.3.1 Step 1: Choose Mounting Location

Locate the controller in area protected from direct sun, high temperature, and water. Make sure there is good ventilation.

3.3.2 Step 2: Check For Clearance

Place the controller in the location where it will be mounted. Verify that there is sufficient room to run wires and that there is sufficient room above and below the controller for airflow. Ensure cool air can move freely through the heat sink fins at the bottom of the unit.

3.3.3 Step 3: Mark Holes

Use a pencil or pen to mark the 4 mounting hole locations on the mounting surface, (*Refer to the dimensional drawing in Fig 3.1*).

3.3.4 Step 4: Drill Holes

Remove the controller and drill 4 holes in the marked locations. Use drill size #29 for #8 self tapping screws.

3.3.5 Step 5: Secure Controller

Place the controller on the surface and align the mounting holes with the drilled holes in Step 3.3.4. Secure the controller in place using 4, #8 self tapping screws.

3.4 CONNECTIONS

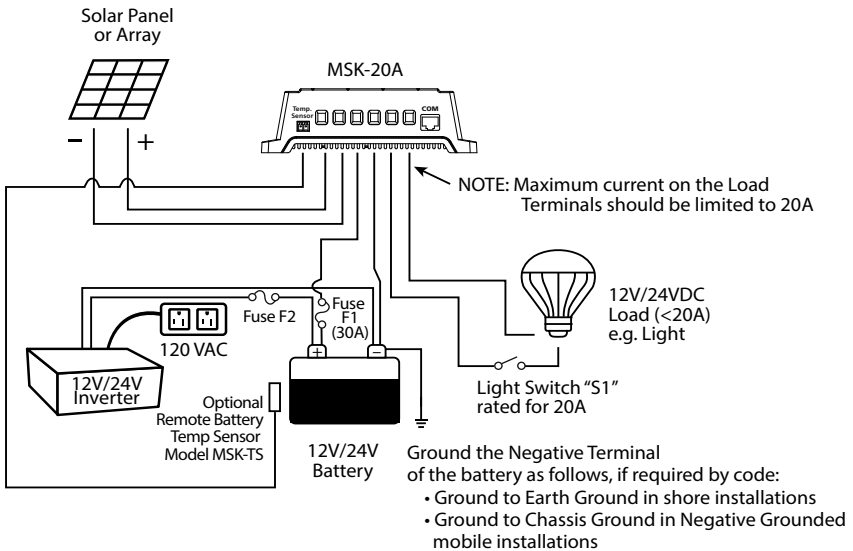

Fig 3.2: Wiring Diagram

SECTION 3 | Installation

3.4.1 Step1: Battery Connection



WARNING!

RISK OF EXPLOSION OR FIRE! NEVER SHORT CIRCUIT BATTERY POSITIVE (+) AND NEGATIVE (-).



MISE EN GARDE!

RISQUE D'EXPLOSION OU D'INCENDIE! NE COURT-CIRCUITEZ JAMAIS LA BATTERIE POSITIF (+) ET NÉGATIF (-).

Refer to Fig 3.2

Before the battery is connected:

- Make sure that battery voltage is greater than 8V so as to start up the controller.
- For 24V systems, make sure the battery voltage is not less than 18V to ensure that battery system voltage is correctly sensed as 24V.
- Battery system voltage will be sensed automatically when the controller starts up for the first time.
- A 30A fuse (F1) is required to protect the cable run from the battery to the charge controller against short circuit. Install the fuse not more than 7" from the battery Positive terminal. Do not insert the fuse at this time.

3.4.2 Step 2: Load Connection through Load Terminals (**Limited to 20A**)

Refer to Fig 3.2

The Load Terminals of the controller can be connected to such electrical devices as lights and other devices with load current of up to 20A. Controller provides power to the load(s) through the battery.

When load(s) are fed from the Load Terminals, the controller will provide the following protections on the load side:

Protect the battery as follows:

- **Battery Low Voltage Alarm ($\leq 12V/24V$):** Battery Status LED (2, Fig 2.1) will be steady ORANGE. Output will still be available at Load Terminals. This condition will auto reset at 12.2 / 24.4V



WARNING!

CURRENT OUTPUT ON THE LOAD TERMINALS IS LIMITED TO A MAXIMUM OF 20A. IF HEAVIER LOADS DRAWING MORE THAN 20A LIKE INVERTER ETC. ARE REQUIRED TO BE POWERED, CONNECT THEM DIRECTLY TO THE BATTERY THROUGH APPROPRIATE FUSE "F2" THAT SHOULD MATCH THE DC INPUT CURRENT OF THE INVERTER. THIS FUSE SHOULD ALSO BE INSTALLED WITHIN 7" OF THE BATTERY (+) TERMINAL.

SECTION 3 | Installation



MISE EN GARDE!

LA SORTIE DE COURANT SUR LES BORNES DE CHARGE EST LIMITÉE À UN MAXIMUM DE 20A. SI DES CHARGES PLUS LOURDES TIRENT PLUS DE 20A COMME UN ONDULEUR, ETC. DOIVENT ÊTRE ALIMENTÉS, CONNECTEZ-LES DIRECTEMENT À LA BATTERIE VIA LE FUSIBLE APPROPRIÉ «F2» QUI DOIT CORRESPONDRE AU COURANT D'ENTRÉE CC DE L'ONDULEUR. CE FUSIBLE DOIT ÉGALEMENT ÊTRE INSTALLÉ À MOINS DE 7 "DE LA BORNE (+) DE LA BATTERIE.

- **Battery Over Voltage ($\geq 16V/32V$):**
 - Battery Status LED (2, Fig 2.1) will be fast blinking GREEN (4 Hz)
 - Load will be disconnected. This condition will be automatically reset at 15.0 / 30.0V.
- **Low Voltage - Load Disconnect ($\leq 11.1V/22.2V$):** Battery Status LED (2, Fig 2.1) will be steady RED. Output to Load Terminals will be disconnected. This condition will be auto reset at 12.6/ 25.2V

Protect the load as follows:

- **Overload or short circuit in the load connected to the Load Terminals:** Output to Load Terminals will be disconnected (Refer to Sections 5.1.4 & 5.1.5 for details)

Connect the Positive (+) and Negative (-) of load(s) to controller Load Terminals as shown in Fig 3.2.

3.4.3 Step 3: Solar Panel / Array Connection



WARNING!

RISK OF ELECTRIC SHOCK! EXERCISE CAUTION WHEN HANDLING SOLAR CONNECTIONS. HIGH VOLTAGE OUTPUT FROM THE SOLAR PANEL(S)/ARRAY MAY CAUSE SHOCK OR INJURY. COVER THE SOLAR PANEL(S)/ARRAY FROM THE SUN BEFORE INSTALLING SOLAR WIRING.



MISE EN GARDE!

RISQUE DE CHOC ELECTRIQUE! FAITES PREUVE DE PRUDENCE LORS DE LA MANIPULATION DE L'ÉNERGIE SOLAIRE CONNEXIONS. LA SORTIE HAUTE TENSION DES PANNEAUX PHOTOVOLTAÏQUES PEUT PROVOQUER DES CHOCES OU DES BLESSURES. COUVREZ LES PANNEAUX PHOTOVOLTAÏQUES DU SOLEIL AVANT D'INSTALLER LE CÂBLAGE SOLAIRE.

The controller can accept 12V (36 cell) or 24V nominal (72 cell) Solar panel(s) with maximum Open Circuit Voltage of up to 50V. Continuous voltage > 50V will damage the input section of the controller.

3.4.4 Step 4: Battery Temperature Sensing and Compensation

3.4.4.1 Lead Acid Batteries have a Negative "Temperature Coefficient" i.e. the battery charging / discharging voltages will (i) rise due to fall in electrolyte temperature resulting in under charging if charger voltage is not compensated and (ii) fall due to rise in electrolyte temperature resulting

SECTION 3 | Installation

in overcharging if charger voltage is not compensated. *Battery manufacturers, therefore, specify battery charging / discharging voltages and capacities of Lead Acid Batteries at Standard Room Temperature of 25° C.*

3.4.4.2 When the battery electrolyte temperature varies from the Standard Room Temperature of 25° C, the values of charging / discharging voltages will be compensated based on the actual battery electrolyte temperature using parameter called "Battery Temperature Compensation Coefficient". In this controller, this parameter is set at $-3\text{mV}/^{\circ}\text{C}/\text{Cell}$ i.e. (i) $-18\text{mV}/^{\circ}\text{C}$ for 6-cell, 12V battery or (ii) $-36\text{mV}/^{\circ}\text{C}$ for 12-cell, 24V battery.

3.4.4.3 The controller has built-in Temperature Sensor for *indirect and approximate* sensing of battery temperature. For this, *the controller has to be placed very close to the battery*. This built-in sensor is the default sensor if the optional Remote Battery Sensor Model MSK-TS is **NOT** being used.

3.4.4.4 For accurate sensing of the temperature of battery electrolyte, it is recommended that the *optional* Remote Battery Temperature Sensor Model No. MSK-TS is used. This Temperature Sensor comes with 3M/10ft cable with a cylindrical Temperature Sensor Head for battery end and 2-pole Female Connector for the controller end. Install this sensor as follows:

- Attach the Cylindrical Sensor Head half way down the vertical side of the warmest part of the battery in the battery bank so that the sensor picks up the temperature of the electrolyte. Use 1 mil "PVC Pipe Wrap Tape" to tape the sensor to the battery (*pre-clean the battery surface with Rubbing Alcohol prior to placing the tape*)
- Insert the 2-pole Female Connector into the Jack marked "Temp Sensor" (*8 in Fig 2.1*)

3.4.4.5 When the *optional* Remote Battery Temperature Sensor Model MSK-TS is plugged into the controller, the internal Temperature Sensor (*Section 3.4.4.3 above*) will automatically be disabled.

3.4.5 Step 5: Install Fuse

Install 30A fuse "F1" in the battery circuit, (not included) as shown in Fig 3.2.

3.4.6 Step 6: Confirm Power ON

When battery power is applied, the controller will start operating. Refer to Table 4.1 under Section 4.7 for operational information through the Solar Panel / Battery / Status LEDs (*1, 2 & 3 in Fig 2.1*).

SECTION 4 | Operation

4.1 PRINCIPLE OF OPERATION OF SOLAR CHARGING WITH SERIES TYPE PULSE WIDTH MODULATION (PWM) CONTROL

The design and operation of MSK-20A is based on Series Type PWM (*Pulse Width Modulation*) control at PWM frequency of 25 Hz.

4.2 PWM EXPLANATION

The output of the Solar Panel(s)/Array is connected to the battery in series with a Mosfet Switch inside the controller. A Micro-controller controls the ON / OFF operation of the Mosfet Switch to control the charging current and consequently, the State of Charge of the battery.

A Solar Panel is a current source that outputs constant current equal to its Short Circuit Current (I_{sc}) over a wide voltage range (*provided Irradiance Level, Spectrum and Cell Temperature remain constant*). For example, at STC, a typical 12V nominal, 45W PV Panel may provide constant Short Circuit Current (I_{sc}) of around 3A over voltage range from 0V to around 15V.

PWM consists of repetitive cycles of controlled duration of ON and OFF states of the Series Connected Mosfet Switch inside the controller. The sum of ON and OFF times of one cycle is called the Pulse Period. In PWM control, the duration of the Pulse Width (*ON time*) is varied (*modulated*) and is defined by "Duty Cycle" which is the ratio of the "ON Time" to the "Pulse Period". Duty Cycle is normally specified in %. Thus, 0% Duty Cycle will mean that the switch is constantly OFF (*will output 0A*) and 100% Duty Cycle will mean that the switch is constantly ON and will output the full instantaneous Short Circuit Current " I_{sc} " of the panel. For Duty Cycles > 0% and < 100%, the switch will alternate between ON and OFF states in a controlled manner in every cycle and will output variable average current within a range of 0A to the full Short Circuit Current I_{sc} . Thus, through PWM control, the Mosfet Switch inside the controller converts constant Short Circuit Current (I_{sc}) of the Solar Panel(s) to controlled average charging current at its output by varying the Duty Cycle. The average value of the charging current is equal to the instantaneous input value of Short Circuit Current (I_{sc}) of the panel multiplied by the Duty Cycle.

4.3 PWM CHARGING IN MSK-20A

Battery charging is a current based process. Current fed to the battery results in re-charging of the cells and consequent rise in battery voltage. Controlling the current will control battery voltage. For 100% return of capacity, and for prevention of excessive gassing and sulfation, the battery charging voltage is required to be controlled at the specified Voltage Regulation Set Points for Absorption and, Float Charging Stages for different battery types. Battery can, thus, be charged at the specified Voltage Regulation Set Points by PWM of the charging current through control of Duty Cycle as explained above. The controller checks the battery voltage and updates the Duty Cycle regularly at a very fast rate. The Duty Cycle is proportional to the difference between the sensed battery voltage and the Voltage Regulation Set Point. Once the specified Voltage Regulation Set Point is reached, it is kept steady - rise in voltage is compensated by reducing the average current by reducing the Duty Cycle and fall in voltage is compensated by raising the average current by raising the Duty Cycle. These fast updates on battery voltage measurements and Duty Cycle corrections ensure charging of the battery at the specified Voltage Regulation Set Point with minimum voltage deviation.

SECTION 4 | Operation

4.3.1 Optimum PWM Frequency

The PWM frequency can range from tens of Hz to around 1000 Hz. At higher frequencies, the time period between the cycles is lesser and is not sufficient to complete the electro-chemical reactions. At lower frequencies, the rise times of the charging pulses are lower which results in higher gas bubble formation resulting in lowering of active surface area and increase of internal impedance. In MSK-20A, frequency of 25 Hz is used for optimum charging performance.

4.3.2 Benefits of pulsing nature of charging current during PWM

During PWM voltage regulated stages of Absorption, and Float Duty Cycle is lower and the charging current is in the form of pulses. Pulsing charging current allows some Oxygen and Hydrogen generated during charging chemical reactions to be chemically combined again and then absorbed. This eliminates concentration polarization and ohm polarization and reduces the internal pressure of the battery. Consequently, charging process is smoother and more capacity is returned to the battery. Further, pulsing current provides more time to react, which reduces the gassing volume and improves the absorption rate of charging current.

4.4 CHARGING PROFILES

The controller has been set for the following 2 Charging Profiles:

(a) **3-Stage Normal Profile:** See Fig 4.1 & Section 4.4.1 for details

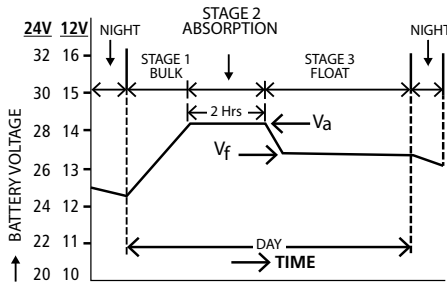

Fig 4.1 3-Stage Normal Profile
Bulk → Absorption → Float

LEGEND FOR FIG 4.1

V_a - Absorption Stage Voltage

V_f - Float Stage Voltage

NOTE: Voltages represented by the Charging Curves are based on battery voltages

Figs 4.1 Charging Profile

4.4.1 3-Stage Normal Charging Profile

Please refer to Fig 4.1

This charging cycle is carried out for normal day to day charging. Charging is sequential: Stage 1: Bulk Stage (Maximum available Current from the solar panel / solar array = Instantaneous Short Circuit Current "Isc" of the solar panel / solar array) → Stage 2: Absorption Stage (Constant Voltage) → Stage 3: Float Stage (Constant Voltage).

SECTION 4 | Operation

4.4.1.1 Stage 1 - Bulk Stage

Please refer to Fig 4.1

This is almost a constant current stage. During this stage, the Mosfet Switch is kept at 100% Duty Cycle (*ON continuously*) and hence, maximum current equal to the available instantaneous Short Circuit Current "Isc" of the solar panel(s) / sola array is fed to the battery and the battery voltage starts rising. When the voltage rises to the Absorption Voltage "Va", the controller transitions to Absorption Stage. At the end of the Bulk Stage, the battery is charged to around 80% capacity. The balance of 20% capacity is restored in the next Absorption Stage.

4.4.1.2 Stage 2 - Absorption Stage

Please refer to Fig 4.1

The controller enters this stage from the previous Bulk Stage when the battery voltage rises to the Absorption Stage Voltage "Va" which is internally set as follows:

- "Va" for 12V battery: 14.4V for Sealed Lead Acid (*AGM - Absorbed Glass Mat*)
- "Va" for 24 V battery: 28.8V for Sealed Lead Acid (*AGM - Absorbed Glass Mat*)

This stage is timed for 2 Hrs - either continuous or cumulative.

This is a constant voltage stage and the Mosfet Switch operates under PWM control by feeding pulsing Short Circuit Current "Isc" with constantly reducing Duty Cycle (< 100% to > 0%) / average current to keep the battery voltage constant at the Absorption Stage Voltage "Va". This is an intentional, controlled over voltage condition for the battery for 2 Hrs. This is necessary to return the balance 20% of the capacity. At this voltage, the battery starts gassing (*evolution of Hydrogen and Oxygen due to electrolysis of water in the electrolyte*) and hence, it is necessary to exit this stage as soon as 100% capacity is restored. If this over voltage condition is allowed to continue after 100% recharging, the battery will be damaged due to effects of overcharging like overheating, loss of water (*Flooded Batteries*), corrosion of the Positive plates and excessive build up of pressure resulting in acid spillage due to opening of pressure activated relief valves (*Sealed Batteries*). The balance of 20% of the battery capacity is restored in this stage. As the battery capacity rises from 80% to 100%, the PWM control tapers the current by continuously reducing the Duty Cycle from < 100% to > 0%.

Change over to the next Float Stage Voltage "Vf" (*13.8V for 12 V battery and 27.6V for 24V battery*) is possible only after the battery voltage is held at the selected Absorption Stage Voltage "Va" for continuous or cumulative period of 2 Hours. If Absorption Stage Voltage "Va" cannot be maintained continuously / cumulatively for 2 Hr, transition to Float Stage **WILL NOT** take place.

4.4.1.3 Stage 3 - Float stage

Please refer to Fig 4.1

The controller enters this stage from the previous Absorption Stage after the battery voltage is held at the selected Absorption Stage Voltage "Va" for continuous or cumulative period of 2 Hours.

This is also a constant voltage stage and the Mosfet Switch operates under PWM control by feeding pulsing, instantaneous Short Circuit Current "Isc" with very low Duty Cycle of > 0% to < 10% to keep the battery voltage constant at the Float Stage Voltage "Vf" (*13.8V for 12V battery and 27.6V for 24V battery*). During this stage, the battery is 100% charged and a very low "Trickle Charge" of around 0.1% of the Ah Capacity is required to be fed to the battery to compensate for self-discharge. The battery can be left at this stage for prolonged period of time.

SECTION 4 | Operation

4.4.1.3.1 Automatic Exit from Float Stage to Absorption Stage

The charger will exit Float Stage and enter Absorption Stage (Section 4.4.1.2) automatically as follows:

- (i) During Float Stage, if the load current is more than the current supplied by the Solar Panel(s), the battery voltage will drop. The battery voltage will also drop due to self discharge if there is no sun for prolonged period of time or, if the Solar Panel / Solar Array gets disconnected. If the battery voltage drops to 13.2V for 12V battery or 26.4V for 24V battery, the Controller will revert to Stage 2 - Absorption Stage ([Section 4.4.1.2](#)) or,

4.7 LED INDICATIONS

LED indications for operational status are shown at Table 4.1.



TABLE 4.1 LED INDICATIONS FOR OPERATIONAL STATUS				
Location of LED (Fig 2.1)	Function of LED	Color of LED	LED Lighting Pattern	Operational Status
1	Solar Panel Status LED 	Green	On Steady	Unit is on, but not charging due to insufficient Solar Panel Power.
		Green	Slow Blinking (1Hz)	Unit is charging
		Green	Fast Flashing (4Hz)	Solar Panel, has been connected in reverse polarity (See Section 5.1.3)
		Green	OFF	(i) Solar Panel Voltage is < 5V due to: <ul style="list-style-type: none"> • Night time or, • Solar Panel is disconnected or, • Solar panel is shorted
2	Battery Status LED 	Green	On Steady	Normal Battery Voltage: >12.4V / 24.8V
		Green	Slow Blinking (1Hz)	Battery is fully charged
		Green	Fast Blinking (4Hz)	Battery over voltage: 16V / 32V • Auto reset at 15.0V / 30.0V (See Section 5.1.8)
		Orange	On Steady	Battery low voltage warning: 12V / 24V • Auto reset at 12.2V / 24.4V
		Red	On Steady	Battery low voltage 11.1 / 22.2V • Auto reset at 12.6V / 25.2V (See Section 5.1.10)
		Red	Slow Blinking (1Hz)	Battery over heated to >65°C. Charging is stopped. • Auto reset at <55°C (See Section 5.1.11)

Table Continues on Next Page ►

SECTION 4 | Operation

TABLE 4.1 LED INDICATIONS FOR OPERATIONAL STATUS				
Location of LED (Fig 2.1)	Function of LED	Color of LED	LED Lighting Pattern	Operational Status
3		Red	On Steady	Battery power to Load Terminals is ON
		Red	Off	Battery power to Load Terminals is OFF
		Red	Slow Flashing (1Hz)	Overload on the Load Terminals. Battery power to Load Terminals is OFF (See Section 5.1.4)
		Red	Fast Flashing (4Hz)	Short circuit at Load Terminals. Battery power to Load Terminals is OFF (See Section 5.1.5)
1,2,3	All 3 LED Indicators are blinking: <ul style="list-style-type: none"> Solar Panel / Array Status LED (1, Fig 2.1) = Blinks Green Battery Status LED (2, Fig 2.1) = Blinks Orange Load Status LED (3, Fig 2.1) = Blinks Red 			<ul style="list-style-type: none"> Internal hot spot is >85°C Input and output are disconnected Auto reset at <75°C (See Section 5.1.12)
1,2,3	All 3 LED Indicators are blinking: <ul style="list-style-type: none"> Solar Panel Status LED (1, Fig 2.1) = Blinks Green Battery Status LED (2, Fig 2.1) = Blinks Red Load Status LED (3, Fig 2.1) = Blinks Red 			System voltage error. Battery voltage does not match the controller voltage. Check battery voltage is 12V/24V. Press Load On/Off Button (4, Fig 2.1) to clear the malfunction. (See Section 5.1.14) "System Voltage Error" due to: <ol style="list-style-type: none"> Battery voltage is not within the range of 8-32 VDC

4.8 LOAD ON/OFF CONTROL

When the controller is powered ON, press the Load On/Off Button (4, Fig 2.1) to toggle the load ON and OFF. When load is ON, Load Status LED (3, Fig 2.1) will turn ON - RED.

Load On/Off Button (4, Fig 2.1) is also for clearing (i) "Load Overload" fault (Section 5.1.4), (ii) "Load Short Circuit" fault (Section 5.1.5) and (iii) "System Voltage Error" (See Section 5.1.14)

4.9 BATTERY TEMPERATURE SENSING & COMPENSATION

Refer to Section 3.4.4 for details.

SECTION 5 | Protections & Troubleshooting

5.1 PROTECTIONS

5.1.1 Over Current of Solar Panel / Array

If the output current of the solar panel / array exceeds 20A rating of the controller, the charging current will be limited to the rated current of 20A.

5.1.2 Short Circuit of Solar Panel / Array

If solar panel / array is short circuited, remove the short circuit to resume normal operation automatically. The controller will not be damaged due to short circuit on the solar panel input side.

5.1.3 Reverse Polarity of Solar Panel / Array Input Connection

Fully protected against reverse polarity connection of solar panel / array. Solar Panel Status LED (1, Fig 2.1) will fast blink Green @ 4Hz. The controller will not be damaged. Correct the polarity of connection to resume normal operation.

5.1.4 Overload in the Load(s) Connected to Load Terminals

When the load is within the rated current of 20A, Load Status LED (3, Fig 2.1) will be steady RED. When the load rises to ≥ 1.05 times (20.0A) for around 3 sec, overload protection is activated as follows:

1. Load will be disconnected for 5 sec – Load Status LED (3, Fig 2.1) will slow blink 5 times @ 1Hz
2. Load will be reconnected – Load Status LED (3, Fig 2.1) will be steady
3. If overload $\geq 21.0A$ continues for 3 sec, the load will be disconnected for 10 sec and the Load Status LED (3, Fig 2.1) will blink 10 times @ 1Hz
4. Load will be reconnected – Load Status LED (3, Fig 2.1) will be steady
5. If overload $\geq 21.0A$ continues for 3 sec, the load will be disconnected for 15 sec and the Load Status LED (3, Fig 2.1) will slow blink 15 times @ 1Hz
6. Load will be reconnected – Load Status LED (3, Fig 2.1) will be steady
7. If overload $\geq 21.0A$ continues for 3 sec, the load will be disconnected for 20 sec and the Load Status LED (3, Fig 2.1) will blink 20 times @ 1Hz
8. Load will be reconnected – Load Status LED (3, Fig 2.1) will be steady
9. If overload $\geq 21.0A$ continues for 3 sec, the load will be disconnected for 25 sec
10. Load will be reconnected – Load Status LED (3, Fig 2.1) will be steady
11. If overload $\geq 21.0A$ continues for 3 sec, **the load will be disconnected permanently and the Load Status LED (3, Fig 2.1) will slow blink continuously @ 1Hz**
 - To reset, remove overload and press the Load On/Off Button (4, Fig 2.1) for around 8 sec

5.1.5 Load Short Circuit

Short circuit condition is detected if the output current is ≥ 2 times (20A) momentarily. The protection is activated and reset as follows:

1. If load current $\geq 40A$ is detected momentarily, the load will be disconnected immediately and the Red Load Status LED (3, Fig 2.1) will fast blink @ 4Hz for 5 sec
2. After 5 sec, the load will be reconnected. If short circuit condition continues, the load will be disconnected immediately and the Red Load Status LED (3, Fig 2.1) will continue to fast blink @ 4Hz for 10 sec.
3. After 10 sec., the load will be reconnected. If the short circuit condition continues, the load will be disconnected immediately and the Red Load Status LED (3, Fig 2.1) will continue to fast blink @ 4Hz for 15 sec.

SECTION 5 | Protections & Troubleshooting

4. After 15 sec., the load will be reconnected. If the short circuit condition continues, the load will be disconnected immediately and the Red Load Status LED (3, Fig 2.1) will continue to fast blink @ 4Hz for 20 sec.
5. After 20 sec., the load will be reconnected. If the short circuit condition continues, the load will be disconnected immediately and the Red Load Status LED (3, Fig 2.1) will continue to fast blink @ 4Hz for 25 sec.
6. After 25 sec., the load will be reconnected. If the short circuit condition continues, **the load will NOT be reset and the Red Load Status LED (3, Fig 2.1) will continue to fast blink @ 4Hz until the short circuit condition is removed and manual reset is carried out by pressing the Load On/Off Button (4, Fig 2.1) for 8 sec.**

5.1.6 Battery Reverse Polarity

Fully protected against battery reverse polarity. The controller will not be damaged. Correct polarity of wiring to resume normal operation.

5.1.7 Limiting Automatic Increase in Charging Stage Voltages Due Battery Temperature Compensation (**Parameter “Charging Limit Voltage”**)

Refer to Section 3.4.4 on battery temperature sensing and compensation.

The values of parameters (i) “Absorption Stage Voltage” (Section 4.4.1.2), and (ii) “Float Stage Voltage” (Section 4.4.1.3) are temperature compensated based on parameter “Battery Temperature Compensation Coefficient” (*18mV/°C for 12V battery and -36mV/°C for 24V battery*). When the battery temperature falls below 25°C, the above Absorption Stage / Float Stage Voltages will be compensated (**raised**) automatically. Unlimited automatic raising of the values of these voltages due to battery temperature falling below 25°C is controlled by parameter called “Charging Limit Voltage” which limits the rise of these voltages to 15.0V for 12V battery and 30.0V for 24V battery

5.1.8 Battery Over Voltage

At 16V/32V battery voltage, charging will be stopped. Battery Status LED (2, Fig 2.1) will be fast blinking Green @ 4Hz. Automatic reset at 15V/30V.

5.1.9 Limiting Automatic Lowering of “Low Voltage Disconnect” Threshold During Battery Temperature Compensation (**Parameter “Discharging Limit Voltage”**)

Refer to Section 3.4.4 on battery temperature sensing and compensation

The threshold of parameter “Low Voltage Disconnect” (*11.1V for 12V battery and 22.2V for 24V battery*) is temperature compensated based on parameter “Battery Temperature Compensation Coefficient” (*18mV/°C for 12V battery and -36mV/°C for 24V battery*). When the battery temperature rises above 25°C, parameter “Low Voltage Disconnect” will be compensated (**lowered**) automatically. Unlimited automatic lowering of the value of this parameter due to battery temperature rising above 25°C is controlled by parameter called “Discharging Limit Voltage” which limits the value of this parameter to value of 10.6V for 12V battery and 21.2V for 24V battery

SECTION 5 | Protections & Troubleshooting

5.1.10 Low Voltage - Load Disconnect

At battery voltage of 11.1/22.2V, the load connected to Load Terminals (*6A, 6B in Fig 2.1*) will be disconnected. Battery Status LED (*2, Fig 2.1*) will be Steady Red. Automatic reset at 12.6/25.2V. **(NOTE: Loads directly connected to the battery will continue to discharge the battery.)**

5.1.11 Over Temperature Protection – Battery

If the battery temperature exceeds 65°C, battery charging is stopped. Battery Status LED (*2, Fig 2.1*) will slow blink Green @ 1Hz. Automatic reset at < 55°C.

NOTE: For this protection, optional Battery Temperature Sensor MSK-TS will be required to be connected (See Section 3.4.4)

5.1.12 Over Temperature Protection – Controller

If the temperature of the controller's heat sink exceeds 85°C, the input and output will be disconnected. The following 3 LEDs will blink:

- Solar Panel Status LED (*1, Fig 2.1*) will blink Green
- Battery Status LED (*2, Fig 2.1*) will blink Orange
- Load Status LED (*3, Fig 2.1*) will blink Red

Input and Output connections will be restored at 75°C

5.1.13 Damaged Temperature Sensor

If the optional external battery temperature sensor Model MSK-TS (*Section 3.4.4*) is short-circuited or damaged, the controller will charge or discharge at the default temperature of 25°C.

5.1.14 System Voltage Error

If the battery voltage does not match the Controller's Battery Voltage specifications of 8-32V, "System Error Voltage" will be indicated (*See Table 4.1 under Section 4.7*). Check battery voltage is 12V / 24V. Press Load On/Off Button (*4, Fig 2*) to clear the fault.

Ensure that the battery voltage is within the acceptable range of 8-32V. Press Load On/Off Button (*4, Fig 2.1*) to clear the fault.

5.1.15 High Voltage Transients

Battery is protected against high voltage transients. In lightning prone areas, additional external lightning protection is recommended.

SECTION 5 | Protections & Troubleshooting

5.2 TROUBLESHOOTING

Troubleshooting Guide is shown at Table 5.1. Please refer to LED indications at Section 4.7, Table 4.1 for supplementary information.

TABLE 5.1 TROUBLESHOOTING GUIDE		
Symptom	Possible Cause	Remarks / Remedy
Solar Panel Status LED (1, Fig 2.1) is not lighted although solar panel(s) are exposed to sunlight	<ul style="list-style-type: none"> Energy from solar panel(s) is not available at the Solar Panel Input Terminals of the controller. Voltage > 8V is not available simultaneously at the Battery Terminals of the controller. 	<ul style="list-style-type: none"> Check solar panel(s) wiring Check battery connection and series fuses and ensure voltage > 8V is available at the battery terminals of the controller
Solar Panel Status LED (1, Fig 2.1) is Steady ON	Low solar irradiance due to poor sunlight. solar panel/array voltage is > 8V but < the battery voltage & hence, no charging	Ensure that solar panel / array is exposed to unobstructed and bright sunlight with no clouds/shading
Solar Panel Status LED (1, Fig 2.1) is fast blinking Green @ 4Hz	<ul style="list-style-type: none"> Solar panel polarity is reversed No charging 	Correct polarity of solar panel connection.
Battery Status LED (2, Fig 2.1) is Green - fast flashing @ 4Hz and there is no output at the Load Terminals	Battery Over Voltage Disconnect Protection has been activated due to high voltage of $\geq 16V$ / $32V$ at the battery output terminals. Solar Panel(s) and Load have been disconnected	Auto reset at 15V / 30V
Battery Status LED (2, Fig 2.1) is steady Orange. Output is available at the Load Terminals	Battery Under Voltage Warning Indication has been activated at $\leq 12V$ / $\leq 24V$. Output is still available at the Load Terminals	<p>Charge the battery. Reduce / switch OFF load to allow the battery voltage to rise.</p> <p>Will be reset automatically when voltage rises to 12.2V / 24.4V and LED will go back to steady Green from steady Orange</p>
Battery Status LED (2, Fig 2.1) is steady Red. No output voltage at the Load Terminals	Protection against over discharge of battery has been activated at $\leq 11.1V$ / $\leq 22.2V$ and the load has been disconnected.	<p>Charge the battery. Reduce / switch off load to allow the battery voltage to rise:</p> <ul style="list-style-type: none"> Load will be reconnected automatically at 12.6V / 25.2V and the LED will go back to steady Green from steady Red
...Continued on next page		

SECTION 5 | Protections & Troubleshooting

TABLE 5.1 TROUBLESHOOTING GUIDE		
Symptom	Possible Cause	Remarks / Remedy
<p>Battery Status LED (2, Fig. 2.1) is slow blinking Red (1 Hz)</p> <p>Charging has stopped</p>	<p>Battery temperature has exceeded 65°C</p> <p>NOTES:</p> <ol style="list-style-type: none"> 1. Refer to Section 3.4.4 2. When battery temperature sensing is being done indirectly by the built-in Battery Temperature Sensor, this trigger temperature of 65°C will be the temperature of this sensor 3. When optional Temperature Sensor Model MSK-TS is used, the above trigger temperature of 65°C will be the actual battery temperature 	<p>Refer to Section 3.4.4</p> <ul style="list-style-type: none"> • When battery sensing is being done indirectly by the built-in Battery Temperature Sensor, check reasons for over heating of the controller. • When external optional Battery Temperature Sensor Model MSK-TS is being used, check reasons for overheating of the battery. <p>The unit will reset automatically when the controller cools to <55°C</p>
<p>Load Status LED (3, Fig. 2.1) is slow blinking Red @ 1Hz.</p> <p>Load has been disconnected.</p>	<p>Load has been disconnected due to overload in the load circuit connected to the Load Terminals:</p> <ul style="list-style-type: none"> • Read Section 5.1.4 for details 	<p>Remove the cause of overload:</p> <ul style="list-style-type: none"> • Reset by manually pressing the Load On/Off Button (4, Fig. 2.1) for 8 to 10 sec • Read Section 5.1.4 for details
<p>Load Status LED (3, Fig. 2.1) is fast blinking Red @ 4Hz.</p> <p>Load has been disconnected.</p>	<p>Load has been disconnected due to short circuit.</p> <ul style="list-style-type: none"> • Read Section 5.1.5 for details 	<p>Remove the cause of short circuit.</p> <ul style="list-style-type: none"> • Reset by manually pressing Load On/Off Button (4, Fig. 2.1) for 8 to 10 sec. • Read Section 5.1.5 for details.
<ul style="list-style-type: none"> • Solar Panel Status LED (1, Fig. 2.1) is blinking Green • Battery Status LED (2, Fig. 2.1) is blinking Orange • Load Status LED (3, Fig. 2.1) is blinking Red <p>Controller has stopped working.</p>	<p>Input and output are disconnected because hot spot inside the controller is > 85°C</p> <ul style="list-style-type: none"> • Read Section 5.12 for details 	<p>Check reasons for overheating. Improve ventilation and ensure proper cool airflow over heat sink surface</p> <ul style="list-style-type: none"> • Will reset automatically when the unit cools down and temperature drops to < 75°C
<ul style="list-style-type: none"> • Solar Panel Status LED (1, Fig. 2.1) is blinking Green • Battery Status LED (2, Fig. 2.1) is blinking Red • Load Status LED (3, Fig. 2.1) is blinking Red <p>Controller has stopped working</p>	<p>System Voltage Error</p>	<ul style="list-style-type: none"> • Battery voltage does not match the controller's battery voltage specifications of 8-34V. <ul style="list-style-type: none"> - Check battery voltage is 12V / 24V. - Press Load On/Off button to clear the malfunction. • Remove Solar Panel and battery connections. Reconnect the battery first and then Solar Panel.
<p>No LED indications</p>	<p>Battery voltage is < 8V</p>	<p>Charge the battery to voltage > 8V using another AC charger.</p>

SECTION 6 | Specifications

6.1 GENERAL

PARAMETER		SPECIFICATIONS	
		12V	24V
CHARGE CONTROLLER			
Type of Charging Control		Series Type, PWM control, PWM Frequency: 25Hz	
Battery Type		Factory preset for Sealed Lead Acid (AGM)	
Battery System Voltage		12V / 24V Nominal; Auto Sensing (<i><18V sensed as 12V / >18V sensed as 24V</i>)	
Working Voltage Range of Charge Controller		8V to 32V	
Rated Battery Charging Current		Up to 20A	
Rated Current on Load Terminals		20A	
Charge Circuit Voltage Drop		≤ 0.28V	
Discharge Circuit Voltage Drop		≤ 0.20V	
Self Consumption		≤ 8.4mA for 12V battery / 7.8mA for 24V battery	
Charging Stages		Bulk, Absorption, Float	
Charging Profile		Bulk Stage → Absorption Stage → Float Stage	
Bulk Stage Current		Equal to Instantaneous Short Circuit Current I _{sc} of the Solar Panel(s) / Maximum 20A	
Absorption Stage Voltage		14.4V	28.8V
Absorption Stage Duration		2 Hrs	
Float Stage Voltage		13.8V	27.6V
Automatic Reset to Absorption Stage		13.2V	26.4V
Charging Limit Voltage		15.0V Auto Reset: 14.5V	30.0V Auto Reset: 29.0V
Discharging Limit Voltage		10.6V	21.2V
Over Voltage Disconnect Voltage		16.0V Auto Reset at 15.0V	32.0V Auto Reset at 30.0V
Low Voltage Warning		12.0V Auto Reset at 12.2V	24.0V Auto Reset at 24.4V
Low Voltage Disconnect (Disconnect Load)		11.1V Auto Reset at 12.6V	22.2V Auto Reset at 25.2V
Battery Temperature Compensation Coefficient	Built-in Temp Sensor	-18mV/°C	-36mV/°C
	External Temp Sensor Model MSK-TS (<i>Optional</i>)		
INPUT – SOLAR PANEL(S) / ARRAY			
Maximum Open Circuit Voltage		50V	
Maximum Short Circuit Current		20A	
...Continued on page 27			

SECTION 6 | Specifications

PARAMETER	SPECIFICATIONS	
	12V	24V
INPUT / OUTPUT CONNECTIONS		
Type of connectors	Moving Cage Type for Up to AWG #8 / 10mm ² wire size	
PROTECTIONS		
Protections	Solar panel over current; solar panel short circuit; solar panel reverse polarity; Battery reverse polarity; Battery over voltage; Controller / Battery overtemperature; Overload and short circuit protections on Load Terminals	
COMPLIANCE		
Compliance marking	CE Marked	
Safety Standards	IEC 62109-1:2010 IEC 62109-2:2011	
Electro Magnetic Compatibility (EMC Standards)	Emissions : EN61000-6-3 Immunity: EN61000-6-1	
RoHS Standard	RoHS Directive 2011/65/EU	
ENVIRONMENTAL		
Operating Temperature	-35°C to +50°C	
Storage Temperature	-35°C to +80°C	
Humidity	≤ 95% Non Condensing	
Ingress Protection (IP) Rating of Enclosure	IP-30 (NOT waterproof)	
MECHANICAL		
Overall Dimensions	159.6 x 81.4 x 47.88 mm	
Weight	0.3 kg	

NOTES:

1. Battery charging & protection voltages are at 25°C
2. Specifications are subject to change without notice

SECTION 7 | Warranty

2 YEAR LIMITED WARRANTY

MSK-20A Solar Charge Controller manufactured by Samlex America Inc. (the “Warrantor”) are warranted to be free from defects in workmanship and materials under normal use and service. The warranty period is 2 years for the United States and Canada, and is in effect from the date of purchase by the user (the “Purchaser”).

Warranty outside of the United States and Canada is limited to 6 months. For a warranty claim, the Purchaser should contact the place of purchase to obtain a Return Authorization Number.

The defective part or unit should be returned at the Purchaser’s expense to the authorized location. A written statement describing the nature of the defect, the date of purchase, the place of purchase, and the Purchaser’s name, address and telephone number should also be included.

If upon the Warrantor’s examination, the defect proves to be the result of defective material or workmanship, the equipment will be repaired or replaced at the Warrantor’s option without charge, and returned to the Purchaser at the Warrantor’s expense. (Contiguous US and Canada only)

No refund of the purchase price will be granted to the Purchaser, unless the Warrantor is unable to remedy the defect after having a reasonable number of opportunities to do so. Warranty service shall be performed only by the Warrantor. Any attempt to remedy the defect by anyone other than the Warrantor shall render this warranty void. There shall be no warranty for defects or damages caused by faulty installation or hook-up, abuse or misuse of the equipment including exposure to excessive heat, salt or fresh water spray, or water immersion.

No other express warranty is hereby given and there are no warranties which extend beyond those described herein. This warranty is expressly in lieu of any other expressed or implied warranties, including any implied warranty of merchantability, fitness for the ordinary purposes for which such goods are used, or fitness for a particular purpose, or any other obligations on the part of the Warrantor or its employees and representatives.

There shall be no responsibility or liability whatsoever on the part of the Warrantor or its employees and representatives for injury to any persons, or damage to person or persons, or damage to property, or loss of income or profit, or any other consequential or resulting damage which may be claimed to have been incurred through the use or sale of the equipment, including any possible failure of malfunction of the equipment, or part thereof. The Warrantor assumes no liability for incidental or consequential damages of any kind.

Samlex America Inc. (the “Warrantor”)
www.samlexamerica.com

Contact Information

Toll Free Numbers

Ph: 1 800 561 5885

Fax: 1 888 814 5210

Local Numbers

Ph: 604 525 3836

Fax: 604 525 5221

Website

www.samlexamerica.com

USA Shipping Warehouses

Kent, WA

Plymouth, MI

Canadian Shipping Warehouse

Richmond, BC

Email purchase orders to

orders@samlexamerica.com



samlexamerica®