

QRail[®] System

QClick Technology[®]

Rail Mounting System

Installation Manual



Table of Contents

1. Introduction...1

- 1.1 Short Description...1
- 1.2 About this Manual...1
- 1.3 Warnings...1
- 1.4 Ratings...3

2. Technical Description...4

- 2.1 System Overview...4
- 2.2 QRail Components...5
- 2.3 Technical Data...6
- 2.4 System Electrical Bonding...7
- 2.5 System Electrical Grounding...11

3. Important Mounting Information...13

- 3.1 Conditions of Use...13
- 3.2 Mounting Preparations...13
- 3.3 Mounting Aids and Required Tools...14
- 3.4 Fastener Torque Settings...14

4. Planning the Module Area...15

5. Installation of Roof Attachments and Rails...16

- 5.1 Select QRail Configuration...16
- 5.2 QRail Preparation...17
- 5.3 QRail Installation on Roof-top...19
- 5.4 End Caps...21

6. Module Installation...22

- 6.1 Module Level Power Electronics Installation...22
- 6.2 Installing Mid- & End-Clamps with QClick Technology®...23
- 6.3 Installing the End Modules...24
- 6.4 Installing the Inner Modules...26
- 6.5 Installing Additional Module Rows...26

7. Maintenance...28

- 7.1 Inspection...28
- 7.2 Testing...28

8. List of UL2703 Evaluated and Approved Modules...39

1. Introduction

1.1 Short Description

The QRail PV mounting system is a strong, versatile system for mounting PV modules on low and steep-sloped roofs. The system consists of aluminum module support rails and includes all necessary components in order to attach the rails to each other, to attach the rails to the roof attachment, and to attach the modules to the rails; it also includes other various accessories, such as module level power electronic (MLPE) attachments and a skirt system. The system allows modules to be mounted in portrait or landscape and can also be configured for shared rail and fixed tilt design in either orientation. It accommodates most framed modules. Bonding is fully integrated into the QRail system.

1.2 About This Manual

This manual describes the installation of the QRail mounting system and provides necessary information regarding components, system planning, and important safety warnings. Sections 1, 2, and 3 provide an overview as well as detailed information about the QRail system and components. Section 4 provides basic module layout and planning information. Sections 5 and 6 provide detailed system assembly and installation instructions. Section 7 provides maintenance requirements, and the last remaining section provides detailed information on UL 2703 evaluated and approved modules.





It is important that you carefully read these Instructions as well as all applicable documents prior to carrying out any installation, maintenance, or disassembly work. These instructions provide you with the information required for the safe and complete installation, maintenance, and disassembly.

1.3 Warnings

The following warnings are used in these Installation Instructions to indicate safety-related information. They include:

- Warning symbols (pictograms)
- Signal words which identify the hazard level
- Information about the type and source of the hazard
- Information about the potential consequences in case of the hazard being disregarded
- Measures for the prevention of hazards and the prevention of injuries or damage to property.

The signal words of the warnings respectively indicate one of the following hazard levels:

			
DANGER	WARNING	CAUTION	ATTENTION
Indicates a potentially mortal danger, disregard for which may result in serious injury or death.	Indicates a potentially dangerous situation which may result in serious injury or damage to property.	Indicates a potentially dangerous situation which may result in minor injuries or damage to the property if ignored.	Indicates potential danger which can result in damage to the property.

Installation Personnel

The QRail system and these instructions are intended for use by qualified personnel. Qualified personnel are those who have skills, knowledge, and training in the installation of photovoltaic mounting systems necessary to follow these instructions in order to safely use the required tools and to carry out the required procedures.

Intended Use

The QRail system is intended for use only as a mounting system for photovoltaic panels and certain associated hardware and components. Any other usage or usage outside the intent or scope of these instructions is considered not as intended and may result in forfeiture of the system warranty. Please contact Quick Mount PV with any questions regarding these requirements.

General Safety Warnings



DANGER

Risk of fatal injury due to falling. Falling from the roof can result in serious injuries or death.

- Please wear and use proper protective equipment
- Secure yourself against falling
- Do not perform any work in strong winds



DANGER

Risk of fatal injury from falling objects. Parts falling from the roof can result in serious injuries or death.

- Before beginning the installation, please ensure that proper safety precautions are observed, only authorized personnel are permitted in and around the construction area and proper protective clothing and equipment are worn.



DANGER

Risk of injury from damage due to roof excessive loads can severely damage the roof and cause injury.

- Before mounting and installation, please make sure that the buildings and especially the roof meet the increased structural requirements of the PV system and the installation operations.



CAUTION

Material damage due to incorrect installation. Incorrectly mounted clamps are a hazard to the integrity of the PV system. PV modules can fall and be damaged.

- Mount all clamp connections in accordance with the instructions.
- Review module manufacturer's documentation for compatibility and compliance with warranty terms and conditions.

1.4 Ratings

ANSI / UL 2703

Conforms to STD UL 2703 (2015) Standard for Safety First Edition: Mounting Systems, Mounting Devices, Clamping/ Retention Devices, and Ground Lugs for Use with Flat-Plate Photovoltaic Modules and Panels.

- Maximum size of modules: 25.6 ft.
- Maximum system voltage is 1500 VDC
- Maximum Fuse Rating: 25A
- Module orientation: Portrait and landscape.

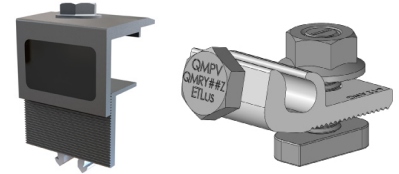

Image 1.4.1
QMR-GLQ-A-50 with
Product Marking

Marking (ANSI / UL 2703)

Product markings are located on the QMR-GLQ-A-50 Grounding Lug or Universal End Clamp as shown in image 1.4.1.

System Fire Rating (ANSI / UL 2703)

The QRail system is intended for roof mounting over a fire-resistant roof covering rated for the application. The QRail fire rating is valid for the following:

- Flush Mounted Systems with any roof slope with Module Types 1 and 2. Maximum system voltage is 1500 VDC
- Tilt Mounted Systems for low roof slope (< 9.5°) applications with Module Types 1 and 2.
- Any module-to-roof gap is permitted, with no perimeter guarding required (QSkirt is optional). This rating is applicable with any third-party roof attachments.
- Class A rated PV systems can be installed on Class A, B, and C roofs without affecting the roof fire rating.

Grounding & Bonding (ANSI / UL 2703)

This racking system may be used to ground and/or mount a PV module complying with UL 1703 only when the specific module has been evaluated for grounding and/or mounting in compliance with the included instructions. The Universal Mid Clamp has been evaluated for multiple use, with no location restrictions.

Mechanical Load Rating (ANSI / UL 2703)

The QRail system has been mechanically tested according to UL 2703 Edition 1 to the following load ratings:

- Downward Pressure: 10 PSF
- Upward Pressure: 5 PSF
- Down-Slope Load: 5 PSF

2. Technical Description

2.1 System Overview

The following is an overview of the major QRail system components as shown in Image 2.1.1.

Note that the actual configuration of each individual system can vary depending on:

- Type of roof (substructure and roofing)
- Type of module
- Number of modules and configuration
- Local conditions

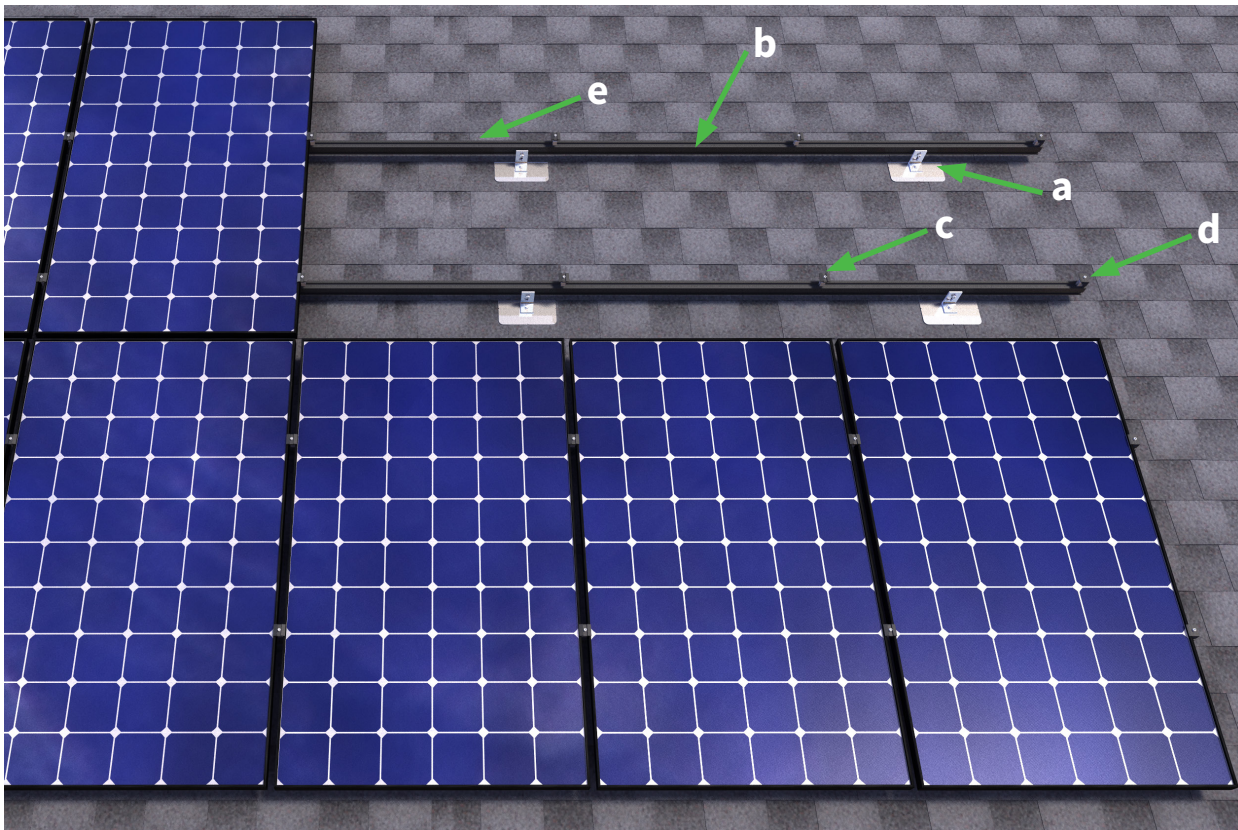
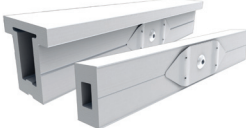





Image 2.1.1

- a** Roof attachment
- b** QRail
- c** Mid clamp
- d** End clamp
- e** Internal QSsplice (not visible)

2.2 QRail System Components

Components	Product Rendering	Torque Value
<p>QRail options: Standard in various lengths Light in various lengths Mill or Black finish</p>		
<p>Internal QSplice: For Standard & Light QRail sizes</p>		
<p>Fixed Size End Clamps w/ QClick Technology®: For modules from 31-50mm thick Mill or Black finish</p>		<p>96 in-lbs (11N-m)</p>
<p>Universal End Clamps w/ QClick Technology®: 2 clamps for modules from 30-45mm or 38-50mm thick Mill or Black finish</p>		<p>96 in-lbs (11N-m)</p>
<p>Hidden End Clamps</p>		<p>108 in-lbs (12N-m)</p>
<p>Universal Bonding Mid Clamps w/ QClick Technology®: 2 clamps for modules from 30-45mm or 38-50mm thick Mill or Black finish</p>		<p>144 in-lbs (16N-m)</p>
<p>QMR-GLQ-A-50 Grounding Lug: Can be installed in any rail channel</p>		<p>T-bolt: 192 in-lbs (22N-m) Wire capture bolt: 6-8 AWG: 60 in-lbs (7N-m) 10-12 AWG: 36 in-lbs (4N-m)</p>
<p>T-Bolt: For attaching roof attachments, MLPEs, and grounding lugs to the rail</p>		<p>192 in-lbs (22N-m)</p>
<p>End Cap options: For Standard & Light QRail sizes Black finish</p>		

2.3 Technical Data

Application	Low and steep slope roofs
Roofing type	Suitable for most types of roofing
Roof slope	Up to - 45° ¹ (up to 12:12)
Building height	Up to 60 ft / 18.25 m ¹
PV modules	Framed
Module orientation	Landscape or portrait
Size of module array	Any size possible ¹
Position of the module array	No special requirements ¹
Distance between roof attachment points	Up to 10 ft / 3 m ¹
Maximum Rail Cantilever	1/3 maximum allowable span for project ¹
Codes & Standards³	IBC/IRC 2018 IBC/IRC 2015 IBC/IRC 2012 ICC-AC428 2012 ASCE 7-05 ASCE 7-10 ASCE 7-16 CBC/CRC 2016 CBC/CRC 2019 ANSI/ UL 2703 Ed. 1 FBC/FRC 2017 Aluminum Design Manual 2010, 2015 SEAOC PV2 - 2012, 2017
Supporting profiles	Extruded Aluminum
Small parts	Stainless steel
Color	Mill or Black finish
Warranty	25 years ²

¹ Different maximum values may apply, depending on site, building, choice of roof attachment and module type. Refer to QRail Code Compliance letters or site-specific engineering.

²Limited product warranty.

2.4 System Electrical Bonding

The QRail system, when properly assembled and installed, provides an integrated electrical bonding path, ensuring that all exposed metal parts and the PV module frames are electrically connected. The QRail employs a number of features to ensure reliable electrical connectivity.

Bonding and Fault Path

Images 2.4.1 and 2.4.2 show the available current path(s) in the QRail system for standard (2 or more rails per row of modules) and shared rail configurations, respectively.

Images 2.4.4 through 2.4.15 provide detail drawings of the labeled connection points.

2.4.1 Standard configuration bonding path (two rail system shown)

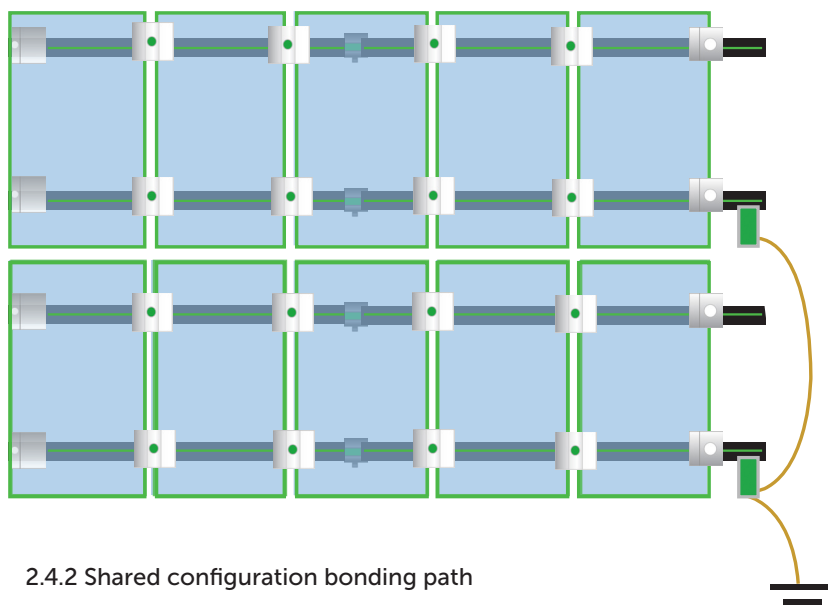



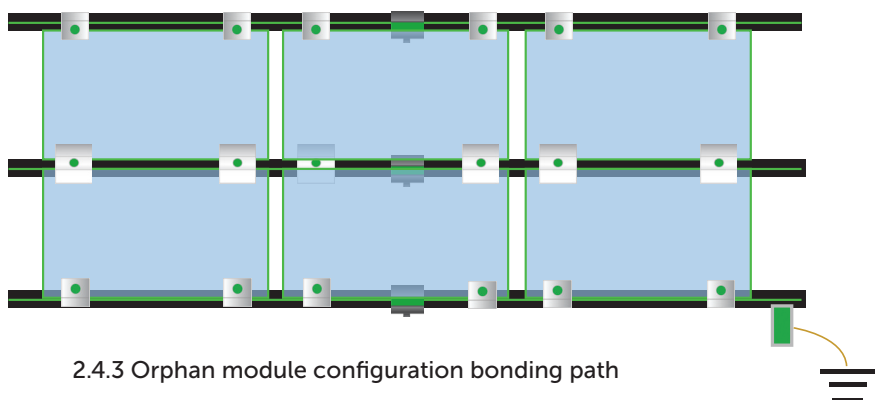



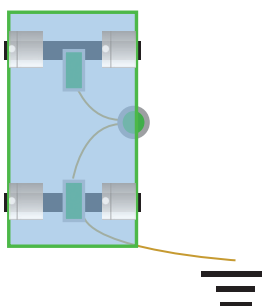

2.4.2 Shared configuration bonding path



2.4.3 Orphan module configuration bonding path



-  Bonding mid clamp
-  Internal bonding splice
-  Standard end clamp
-  Copper ground conductor
-  End clamp w/ WEEB-BMC
-  Hidden end clamp
-  QMR-GLQ-A-50 Grounding lug
-  Alternate module bonding device

NOTE!

The QRail Hidden End Clamp is not NOT a bonding solution and therefore in the case of orphaned modules, an alternative listed module grounding device in conjunction with all rails being grounded must be utilized. See Diagram 2.4.3. Alternatively, use Universal End Clamps with WEEB-BMC installed per diagram 2.4.10.

Bonding with QClick Technology®

As shown in Image 2.4.4 and 2.4.5, the QRail Clamps with QClick Technology and rails are designed with sharp hooks. When the clamp is installed in the rail and the bolt is tightened, the bolt forces the hooks into the rail. Then, as the clamp engages the module and the bolt is tightened to the recommended torque specification [144 in-lbs (16 N-m) for Mid Clamps and 96 in-lbs (11 N-m) for End Clamps], these hooks are pulled into the QClick channel and penetrate the aluminum oxide or painted coating on the rail and electrically bond to the rail, clamp, and bolt. A serrated flange bolt head serves to electrically bond the bolt to the body of the mid or end clamp, thus forming a secure electrical bonding

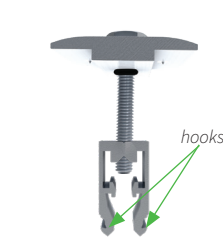

Image 2.4.4
Clamp hooks

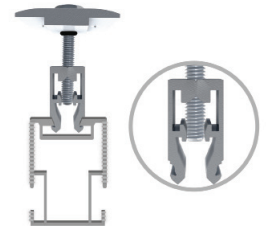

Image 2.4.5
Clamp hooks and rail

PV Module Bonding

PV module frames are electrically bonded to the QRail system by the bonding mid clamps. Bonding mid clamps are preassembled and bonded with stainless steel bonding pins below the clamp head. The stainless steel bonding pins pierce the oxide of the PV module, forming an electrical bond between the module, the clamp head, and thus to the rest of the QRail system. Bonding mid clamps are available in either mill or black finish.

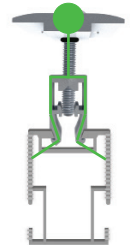

Image 2.4.6
Clamp bonding path

Universal height end clamps may be converted to bonding version by adding optional bonding clips (WEEB-BMC-1¹). Bonding versions of the end clamps are useful when mounting a single module or in shared rail configuration where bonding mid clamps are not utilized. The WEEB-BMC-1 is a stainless steel bonding clip formed with spikes that pierce the oxide of the clamp head and the PV module, forming an electrical bond between the module, the clamp head, and thus to the rest of the QRail system.

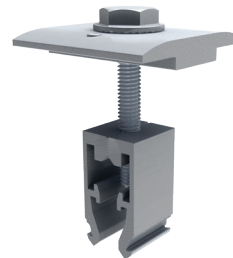

Image 2.4.7
Bonding plate mid clamp
[144 in-lbs (16 N-m)]

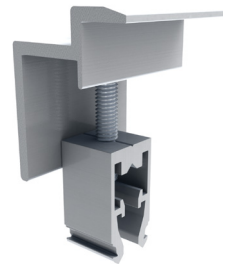

Image 2.4.8
Fixed end clamp
[96 in-lbs(11 N-m)]

NOTE!

The installer is responsible for and shall provide an appropriate method of direct-to-earth grounding according to the latest edition of the National Electrical Code, including NEC 250: Grounding and Bonding and NEC 690: Solar Photovoltaic Systems.

The QRail Hidden End Clamp is NOT a bonding solution and therefore in the case of orphaned modules, an alternative listed module grounding device in conjunction with all rails being grounded must be utilized. See Diagram 2.4.3. Alternatively, use Universal End Clamps with WEEB-BMC installed per diagram 2.4.10.



Image 2.4.9
Universal end clamp
[96 in-lbs (11 N-m)]



Image 2.4.10-1
Universal end clamp
w/WEEB-BMC
[96 in-lbs (11 N-m)]

¹WEEB-BMC -1 is evaluated as an alternative component and may be used interchangeably with a WEEB-BMC Bonding Clip.

Rail Bonding with Internal QSplice

All QRails can be spliced into longer units by means of the QRail Internal QSplice (Image 2.4.11). The bonding splice joins the two rail segments mechanically and electrically for the Standard and Light rails.

The Internal QSplice has a bonding plate that pierces any paint or aluminum oxide layer on the rails. This forms an electrical bond from rail-to-rail through the bonding plate. The splice body is electrically bonded through the bonding

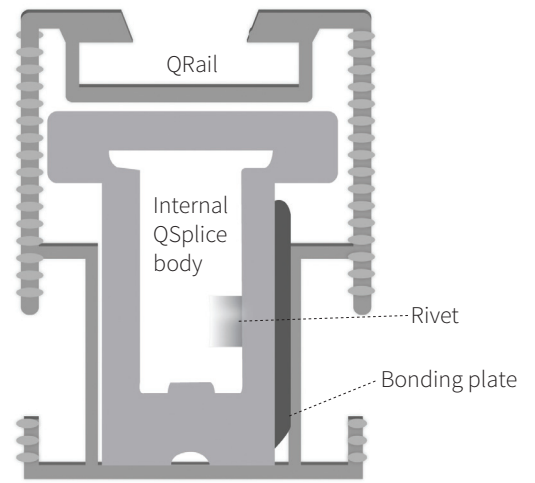

Image 2.4.11 QRail Internal QSplice

Roof Attachment Bonding

The QRail is attached to the roof by roof attachments.

The connection from the attachment device to the rail is made via a stainless steel T-bolt and a stainless steel, serrated flange nut (Image 2.4.12-1 and 2.4.12-2). When secured to the rail [192 in-lbs (22 N-m)], the T-bolt crushes and pierces the aluminum oxide or paint and forms an electrical bond with the rail. The serrated flange nut pierces the coating on the roof attachment and forms an



Image 2.4.12-1
T-bolt

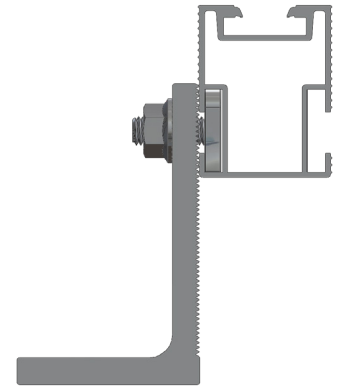



Image 2.4.12-2
L-foot / Rail / T-bolt



WARNING

Full engagement of T-bolt is confirmed when the alignment indicator line on the end of the T-bolt is vertical.

INCORRECT



CORRECT



Module Level Power Electronic (MLPE) or Accessory Bonding

The MLPE is attached to the QRail with the same stainless steel T-Bolt and stainless steel serrated flange nut used for the roof attachment. (Image 2.4.11-1). When secured to the rail [192 in-lbs (22 N-m)], the T-bolt crushes and pierces the aluminum oxide or paint and forms an electrical bond with the rail. The serrated flange nut pierces the coating on the MLPE bracket and forms an electrical bond that is carried through the T-Bolt to the rail.

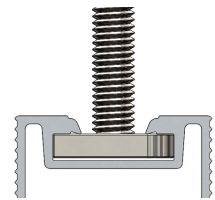



Image 2.4.13
T-bolt in QRail



CAUTION

Use only 20mm long T-bolts when mounting Module Level Power Electronics (MLPE) to top of rail. Place MLPE in a location on the rail that reduces the risk of contact with the module backsheet under load.

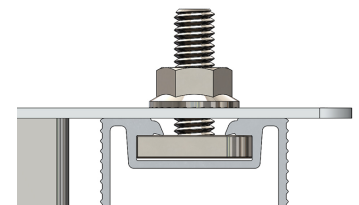

Image 2.4.14
T-bolt in QRail with MLPE installed

NOTE!

Roof attachments and accessories are outside the scope of UL-2703 on grid interactive PV systems. QRail is attached to the roof utilizing compatible roof attachments.

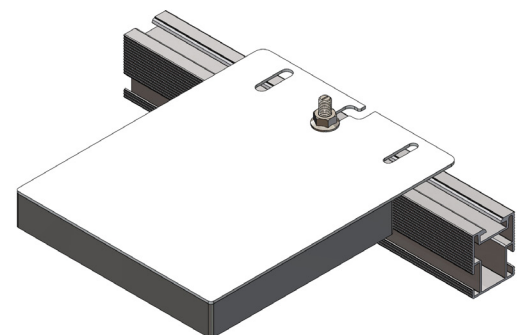

Image 2.4.15
MLPE mounted to QRail with T-bolt.

2.5 System Electrical Grounding

Array Grounding Lug

The QRail system is listed to UL 2703 with the QMR-GLQ-A-50 Grounding Lug as the means to connect the QRail array to the Equipment Grounding Conductor (EGC). It is the system installer's responsibility to determine the appropriate wire size for grounding the array.

To ease and facilitate the process of bonding and grounding the array, it is recommended that these steps are accomplished after the roof attachments and rails are in place prior to module installation. The QMR-GLQ-A-50 Grounding Lug is a special, preassembled lay-in lug designed specifically for use in bonding the array segments (module rows) electrically and for connecting the bonded array to ground. QMR-GLQ-A-50 Grounding Lug is shown in Image 2.5.1:

- a** Lug
- b** Wire capture bolt
- c** M8x20 T-head bolt
- d** M8 serrated flange nut

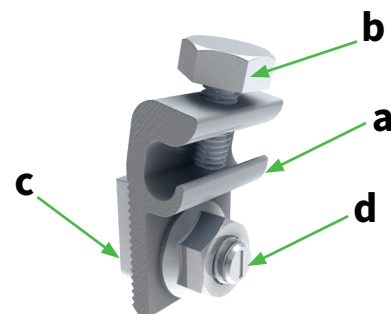

Image 2.5.1
QLug Grounding Lug components
T-bolt:
192 in-lbs (22N-m)
Wire capture bolt:
6-8 AWG: 60in-lbs (7N-m)
10-12 AWG: 36in-lbs (4N-m)

When the PV modules are properly installed, the QRail QClick bonding clamps ensure that all the exposed metal parts and the module frames in each module row or array segment are integrally electrically connected (bonded) with a high-ampacity bond. Each module row must also be connected to ground through the system ground electrode. This is accomplished by using QMR-GLQ-A-50 Grounding Lug to bond each of the array segments or module rows together and for connecting the entire array to the ground electrode. This arrangement is shown in Image 2.5.2.

It is the installer's responsibility to determine the correct wire type, size, and temperature rating for the particular array. The wire sizes and capacities, which can be accommodated

NOTE!

The QRail QSplices have been evaluated and listed to UL 2703; therefore, a spliced rail can be treated as a single solid rail. Additional QMR-GLQ-A-50 Grounding Lugs or bonding jumpers are not required for spliced rails within the thermal break guidelines.

When using a WEEB-Lug 8.0 see our supplemental instructions

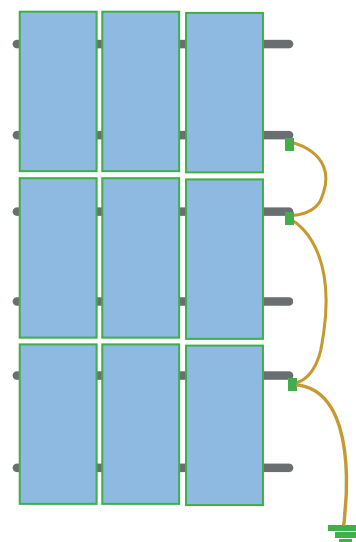

Image 2.5.2
Array bonding connections at each module row

QMR-GLQ-A-50 Grounding Lug Installation

The QMR-GLQ-A-50 Grounding Lug is preassembled with a M8-T-bolt, serrated flange nut, and a wire capture bolt. The lug can be installed in the top or side channel of the QRail rail in any orientation.

- Insert T-head bolt head into the rail's top or side channel. Be sure to allow the bolt head to rotate as far as possible in the T-bolt channel to ensure full engagement of the bolt head with the sides of the channel.
- Tighten M8 nut to [192 ft-lbs (22 N-m)]

Using the above procedure, install a QMR-GLQ-A-50 Grounding Lug on each segment of the array. Once all the QMR-GLQ-A-50 Grounding Lug are installed, use a continuous length of wire to connect each rail by laying wire in the lug wire channel and secure with the wire capture bolt. Torque to 60in-lbs (7N-m) for a 6-8 AWG wire or 36in-lbs (4N-m) for a 10-12 AWG wire.

AWG Wire Size	QMR-GLQ-A-50 Capacity
12 - 6	1 wire
10	2 wires
12	2 wires

Table 2.5.1
Grounding Lug wire capacity

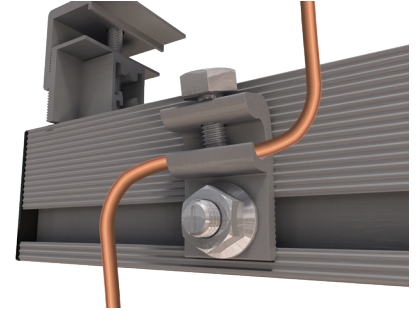

Image 2.5.3
Lug installed in side channel

Array Grounding

The bonded array segments must be connected to the system ground electrode using a single continuous copper wire. This is achieved by routing the grounding cable through the QMR-GLQ-A-50 Grounding Lugs on each array segment. (Image 2.5.3 and 2.5.4)



ATTENTION

Galvanic Reaction

When dissimilar metals come into contact, it is possible that they will react with each other and cause corrosion in one or both of the metal surfaces. Aluminum and copper are particularly reactive with each other; care must be taken to prevent any contact between aluminum components and bare copper wire (Image 2.5.3 and 2.5.4).

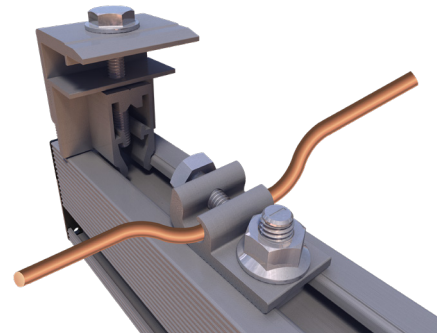

Image 2.5.4
Lug installed in top channel



Caution

Place QMR-GLQ-A-50 grounding lug in a location on the top of the rail that reduces the risk of contact with the module backsheet under load. Side channel installs may also be used to further reduce risk.

3. Important Installation Information

3.1 Conditions of Use

The QRail on-roof system is available with different rail and roof attachment types designed in accordance to and/or compliance with the following codes and standards¹:

- IBC/IRC 2018
- IBC/IRC 2015
- IBC/IRC 2012
- ICC-AC428 2012
- ASCE 7-05
- ASCE 7-10
- ASCE 7-16
- CBC/CRC 2016
- CBC/CRC 2019
- ANSI/ UL 2703 Ed. 1
- FBC/FRC 2017
- Aluminum Design Manual 2010, 2015
- SEAOC PV2 - 2012, 2017

¹Check code-compliance letters for applicable approvals.



DANGER

Risk of injury from damage to roof, Excessive loads can severely damage the roof and cause injury.

- Before mounting and installation, please make sure that the building and especially the roofing meet the increased structural requirements of the PV system and the installation operations.



DANGER

Risk of fatal injury from falling objects. Parts falling from the roof can result in serious injuries or death.

- Before beginning the installation, please ensure that proper safety precautions are observed, that only authorized personnel are permitted in and around the construction area, and that proper protective clothing and equipment are worn.

The design of each system should be verified using QRail Code Compliance letters or site-specific engineering. Please observe the constraints listed in Section 2.3, “Technical Data.”

3.2 Mounting Preparation

Quick Mount PV recommends you ascertain the local conditions and requirements before ordering the QRail. In particular, acquaint yourself with:

- The roof structure and any irregularities
- Dimensions, material, quality, and spacing of the rafters
- Type, quality, and attachment method of the roofing.

3.3 Mounting Aids and Required Tools

In addition to standard hand tools, you will need the following tools:

- ½" or 13mm socket / ½" or 13mm box or open-end wrench
- Drill driver
- Torque wrench (0-200 in-lbs.)
- Reciprocating saw and/or band saw
- Chalk line
- Tape measure
- 5 mm Allen key / 5 mm Allen key power driver (for fixed end clamps only)

Please adhere to the mounting steps listed and be sure to follow the safety instructions. DO NOT use an impact gun.



3.4 Fastener Torque Settings

Proper torque is important to a safe and secure installation. Please refer to Section 2.2 QRail Components for recommended torque values for the various fasteners in the QRail system. Unless specifically directed otherwise, these values should be used for all metal-to-metal attachments.

4. Planning the Module Area

For installation, the QRails are fastened to the building structure with roof attachments (e.g. flashed roof attachments). The roof attachments must be mounted at defined distances, depending on the spacing of the supporting structure, the position on the roof, and the site conditions. The design should be verified using QRail Code Compliance letters or site-specific engineering.

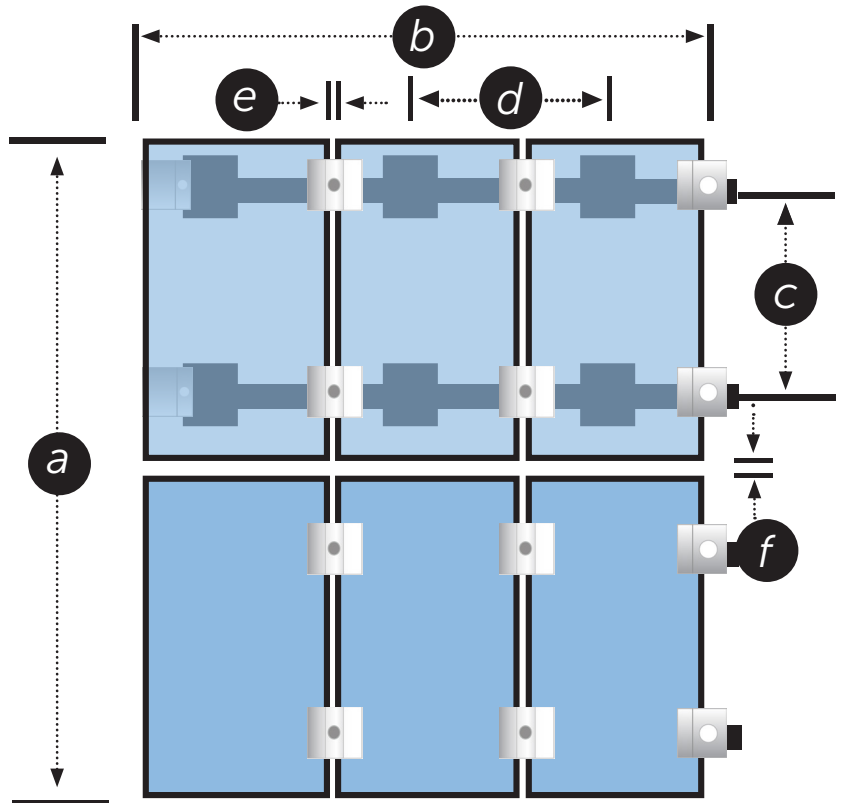

Image 4.1
Module Area

a Height of the module field: Number of modules vertically x module length (+ any clearances)

b Width of the module array:
Using standard end clamps : [number of modules horizontally x module width] + [number of 17mm (11/16in) module gaps] + [2 x 1.2 in (30.5mm) to account for rail extending beyond modules].

Using hidden end clamp: [number of modules horizontally x module width] + [number of 17mm (11/16 in) module gaps].

c Vertical spacing of the base rails: Refer to module manufacturer’s acceptable clamping zones or mounting point locations.

d Horizontal attachment point spacing: Dependent upon roof attachment method and site-specific parameters.

e Distance between the modules = 17mm (1 1/16 in)

f Distance between module rows = 0.25 in. minimum, no maximum distance provided gap does not result in snow damming



DANGER

Risk of fatal injury due to falling. Falling from the roof can result in serious injuries or death.

- Please wear and use proper protective equipment.
- Secure yourself against falling.
- Do not perform any work in strong winds.



DANGER

Risk of fatal injury from falling objects. Parts falling from the roof can result in serious injuries or death.

- Block off the hazard area on the ground prior to beginning work to prevent falling objects injuring persons.
- Ensure that no parts can fall off the roof.
- Please wear required protective equipment.
- Do not linger in the hazard area.
- After completion of the installation, re-check area for loose objects and re-check for proper attachment of racking and modules.

5. Installation of Roof Attachments and QRails

The roof attachments are attached to the roof structure and support the QRails. The permissible distance between the roof attachments depends on several factors and must be calculated specifically for each project. Roof attachments are available for a wide variety of roof types. In many cases, additional items may be required to accomplish flashing or other weather sealing. Suitable products are available from a number of sources. It is the responsibility of the installer to select the appropriate products and to install them correctly.

5.1 Select QRail Configuration

Standard Rail Configuration

Image 5.1.1-1 shows a typical standard rail configuration. In this configuration, a row of modules is supported by two rails under each row of modules. In areas with exceptionally high snow or wind loads it may be necessary to support the modules with three rails, image 5.1.1-2. Can be installed in both flush mounted or at an angle to the roof.

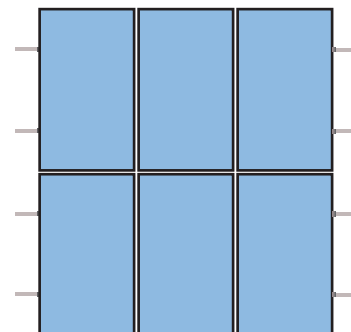

Image 5.1.1-1
Two-rail configuration

Shared Rail Configuration

The rail design of the QRail system allows the use of shared configurations for the Standard rail with standard mid and end clamps. In this configuration, a single rail supports two rows of modules as shown in Image 5.1.2. Shared rails may be used for both landscape and portrait array configurations.

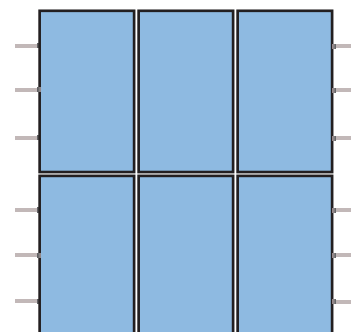

Image 5.1.1-2
Three-rail configuration

Modified Shared Rail Configuration

Modified shared rail configuration is a hybrid of standard and shared rail configurations, image 5.1.3. The first and last rail are set back from the end of the modules in standard module clamping zones to provide additional adjustability while the remaining rails are in shared rail configuration. This configuration maintains the benefits of shared rail configuration using the same clamps, 25% less rails, and full array bonding. May be used for both landscape and portrait module orientations.

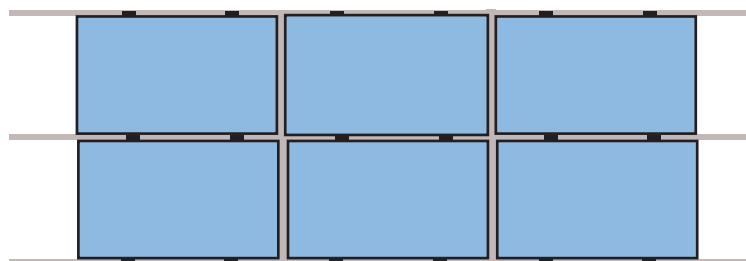

Image 5.1.2
Shared rail configuration

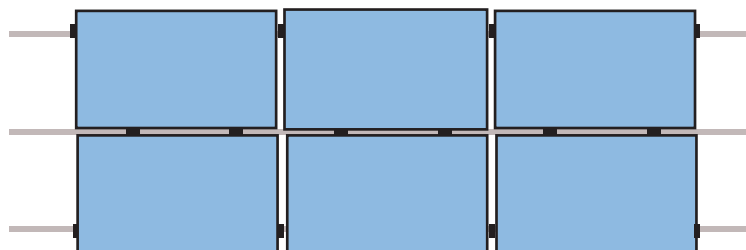

Image 5.1.3
Modified shared rail configuration

NOTE!

When selecting QRail configuration, insure the modules have the appropriate ratings for the project site conditions in the selected configuration. Check the module installation manual to determine if the clamping area falls within the acceptable range for the project design loads.

Precise rail positioning and alignment is critical when installing shared rail systems. Roof attachments which are adjustable in the N-S direction are recommended when installing shared rail systems.

5.2 QRail Preparation

The QRail internal QSplices are used to join two rail sections to provide a single rail section of a desired length.

Internal QSplice Installation

- The internal QSplice is a floating splice, no attachments necessary.
- To join any rail using the Internal QSplice, join the rail sections by sliding the splice into the end of the rail until the bonding plate tabs come into contact with the end of the rail.
- Slide the other rail onto the splice until the end of the rail comes in contact with the bonding plate tabs. Make sure that both rail ends are tight against bonding plate tabs.
- When re-installing the QRail Internal QSplices, insert the splice backwards for optimal performance.

NOTE!

The QRail QSplices are “full-strength” splices. Once a splice is installed and when splice rules are followed it forms an essentially unbroken rail.

To allow for thermal expansion/contraction on wooden structures, spliced rail lengths should not exceed 45 feet without a thermal break of $\frac{3}{4}$ " or more. Do not install modules over this thermal break.

Other structures such as metal buildings and/or temperature deltas other than 100°F could result in increased or decreased thermal break calculations. If this is the case, site-specific calculations may be used in place of a 45 foot thermal break.

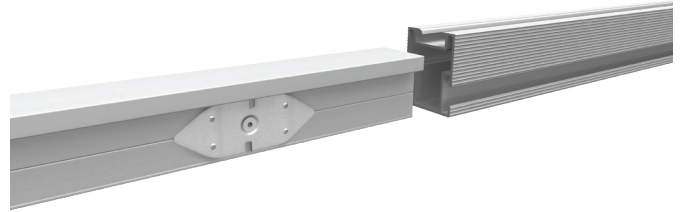

Image 5.2.6

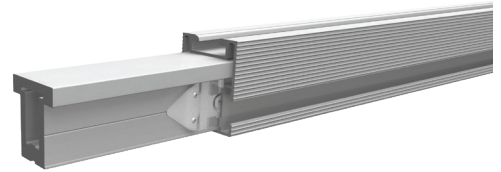

Image 5.2.7

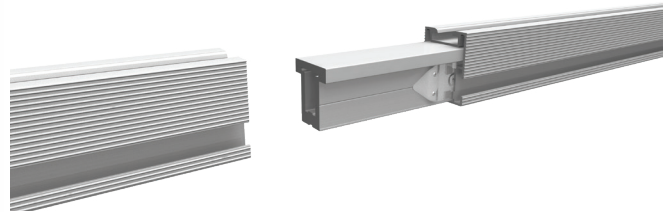

Image 5.2.8



DANGER

The outside edge of the QClick must be installed at least $\frac{1}{2}$ " from end of rail at a splice location.



Image 5.2.9



CAUTION

Spliced rails must have more than one support on both sides of the splice unless conditions in the Code Compliance Letter Installation Notes are met. Find the Code Compliance Letters at quickmountpv.com. Splices cannot be used in cantilever areas.



Image 5.2.10

Thermal Break

In cases where a thermal break is necessary it is recommended to use the splices in conjunction with the Wiley WEEB-BNDJMP8.0 to insure continuous bonding across the thermal break.

Internal Splice:

- Install the internal splice with a $\frac{3}{4}$ " gap between the rails.
- After installing the rails install the WEEB-BNDJMP8.0 across the gap with T-bolts. Insure a loop is left to allow for thermal expansion and contraction and torque T-bolts to [192 in-lbs (22 N-m)].

NOTE!

Align module a minimum of 1.2" from the end of the rail unless utilizing a Hidden End Clamp.



CAUTION

Modules cannot be installed over thermal break. The row of continuous modules must end before the break and a new row must start after the thermal break.

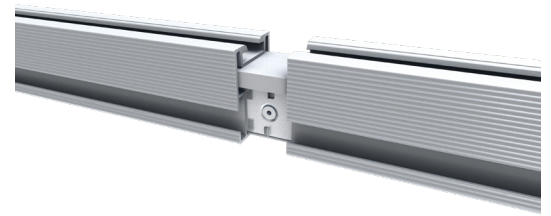

Images 5.2.11
 $\frac{3}{4}$ " thermal break with Internal QSplice

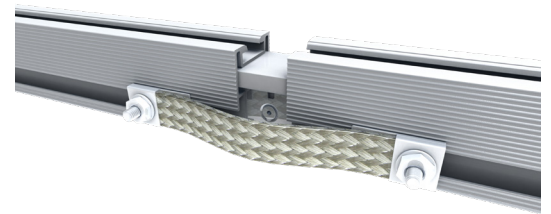

Images 5.2.12
WEEB-BNDJMP8.0 installed with Internal QSplice

5.3 QRail Installation on Roof-top

Installation of the QRail system on most roof-types requires that any penetrations of the roof system be flashed in accordance with the appropriate local codes and roofing best practices.

Installing Standard Rail Configuration

- After determining the location of the array on the roof, mark the rail locations with chalk lines or other suitable method.
- Determine the rafter locations and mark them on the E-W chalk lines.
- For standard rail configuration installations, install roof attachments per the mount manufacturer's instructions.
- Install the roof attachments with mounting brackets along the chalk line per the manufacturer's instructions. For rafter attached systems take care to align the mounting point (mount bolt) as closely as possible to the intersection of the rafter and the chalk line.
- Loosely install the T-bolts on the mounting bracket with the T-bolt facing the rail channel. The mounting bracket may be aligned any direction.
- Position the rail in place and hold each end of the rail against the end mounting bracket. Insert the pre-assembled T-bolt rail fasteners in the end mounting bracket into the slot on the side of the QRail. Set and hold the rail level at the desired height by moving the T-bolt up or down in the mounting bracket.
- Using a ½" or 13 mm socket, tighten the rail fastener nuts to 192in-lbs (22 N-m).
Be sure to allow the bolt head to rotate as far as possible in the T-bolt channel to ensure full engagement of the bolt head with the sides of the channel. **Full engagement is confirmed when the alignment line on the end of the T-bolt is vertical.**
- Proceed along the line of mounting bracket, inserting the T-bolts and tightening as above.
- Repeat the above steps for each rail in the array.

INCORRECT



CORRECT



NOTE!

If rails are to be spliced, the splice should be installed prior to installing the rails onto the L-feet or other roof attachments. See Section 5.2 for rail splicing instructions.



DANGER

Rail must be installed so the mount is fully engaged (edge of rail line to line with edge of mount) and maintain a minimum of 3/4" from the end of the rail to center of T-bolt.

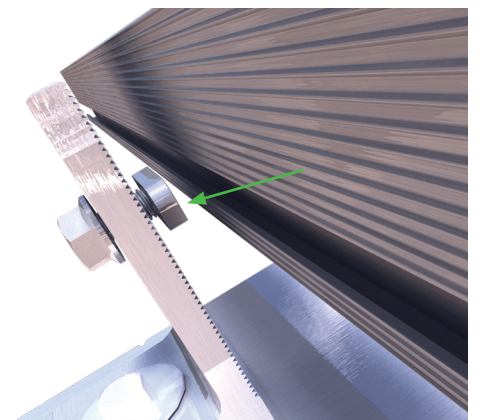

Image 5.3.2

T-bolt correctly positioned for insertion

Installing Shared QRail Configuration

Optional gauge fabrication:

- Fabricate an installation jig shown in image 5.3.3

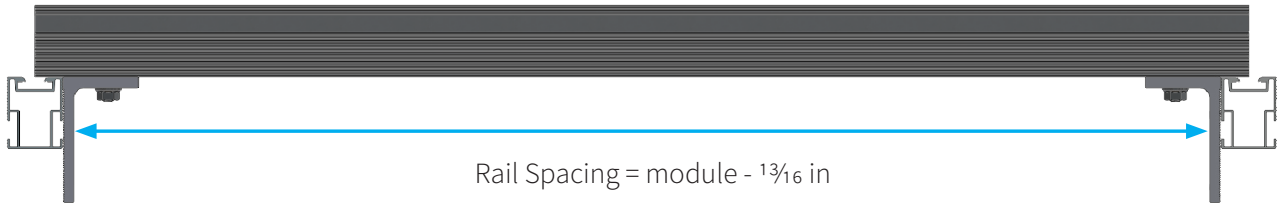

Image 5.3.3
Shared rail distance gauge

Array Installation:

- After determining the location of the array on the roof, mark the location of the lower rail with a chalk line or other suitable method.
- Determine the rafter locations and mark them on the E-W chalk lines.
- Install the roof attachments along the chalk line per the manufacturers' instructions taking care to align the L-foot mounting point (mount bolt) as closely as possible to the intersection of the rafter and the chalk line, accounting for offset of the L-feet. Mounts that are adjustable in the N-S position, such as the Quick Mount PV Shared Rail Composition Mount are recommended.
- Install and tighten the L-feet on the two end mounting/ flashings taking care to place the upright stays of the L-feet as closely aligned with the marked line as possible with the faces of the stays as closely parallel to the line as possible.
- Stretch a reference string between the end L-feet and attach the remaining L-feet with the upright stays just touching the reference string and secure them in position.
- Using the gauge fabricated earlier or using a measuring tape or other suitable method, locate and mark the positions of the remaining rows of the array.
- Install the remaining mounting/ flashings and L-feet and check frequently to ensure proper N-S spacing of the upright surfaces of the L-feet stays within the distance gauge.
- Position the rail in place E-W and hold each end of the rail against the end L-feet. Insert the pre-assembled T-head rail fasteners in the end L-feet into the slot on the side of the QRail rail. Using a spirit level or other suitable device, set and hold the rail level at the desired height by moving the T-head bolt up or down in the L-foot. See Image 5.3.4.
- Using a 1/2" or 13mm socket, tighten the rail fastener nuts to 192 in-lbs (22 N-m). (Be sure to allow the bolt head to rotate as far as possible in the T-head channel to ensure full engagement of the bolt head with the sides of the channel). **Full engagement is confirmed when the alignment line on the end of the T-bolt is vertical.** See Image 5.3.5.
- With each end of the rail secured and the rail level, proceed along the line of L-feet, inserting the T-head bolts into the rail side channel and tightening as above.

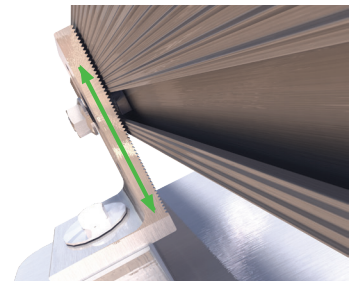
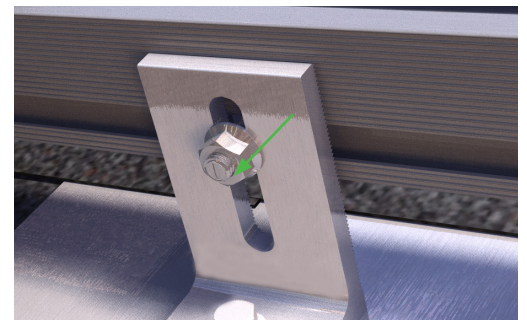

Image 5.3.4



INCORRECT

CORRECT

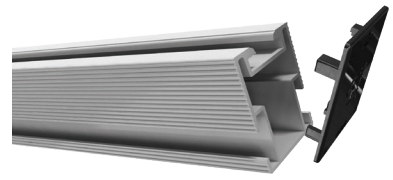

Image 5.3.5

- At this point, it is recommended to install the rail at the opposite side of the array and level it at both ends with respect to the first rail. That is, if the lower-most rail was installed first, the uppermost rail should be installed second and leveled N-S with the first rail and E-W.
- Stretch strings from each corner of the upper and lower rails.
- Position the next rail and attach it as described above, leveling it both E-W and N-S using the strings installed above as reference.
- Repeat the above steps for each rail in the array.

5.4 End Caps

End caps are installed either by simply inserting them into the ends of the rails. See Images 5.6.1-1 & 2.



1



2

Images 5.6.1-1 & 2
End cap installation

6. Module Installation

6.1 Module Level Power Electronic Installation

If module level power electronics (MLPE) are to be used with the array and mounted on the rails, they should be installed prior to installing the PV modules. There are two methods for attaching these components, either the Rail / MLPE Attachment or the Rail/ Low Mount MLPE Attachment. The two options should be selected by the installer based on site conditions, panel clearance, and system configuration.

Rail / MLPE Attachment Installation:

- Insert the T-bolt and flanged nut through the mounting flange of the device to be mounted to the QRail with the T-bolt below the mounting flange.
- Insert T-head into the top channel of the QRail rail and, using a ½" or 13mm wrench or socket, tighten the nut to 192 in-lbs (22 N-m).

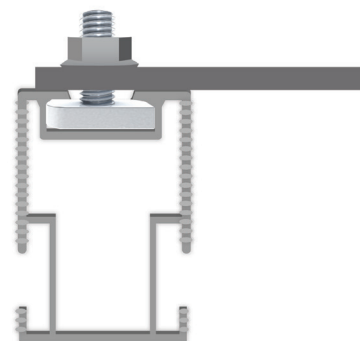

Image 6.1.1
Rail/MLPE Attachment

Rail/ Low Mount MLPE Attachment Installation:

- Insert the T-bolt on the base of the L-Foot into the downslope channel of the QRail Rail and tighten nut to a torque of 192 in-lbs (22 N-m).
- Install additional bolt into the mounting flange of the device and slot in the L-Foot, Bolt facing downward, then install the provided flange nut and torque to 192 in-lbs (22 N-m).

Compatible MLPE:

- Enphase: M250-72, 250-60, M215-60, C250-72, S230, S280, IQ 6, IQ 6+, IQ IQ7, IQ 7A, IQ 7+, IQ 7X, Q Aggregator
- Solar Edge: M1600, P300, P320, P340, P370, P400, P401, P405, P485, P505, P600, P700, P730, P800p, P800s, P801, P850, P860, P950, P960

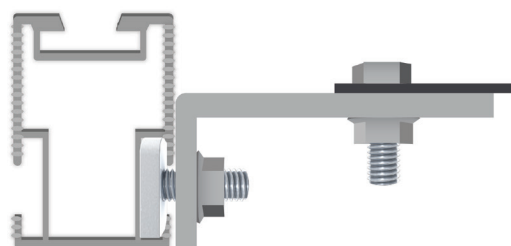

Image 6.1.2
Rail/Low MLPE Adapter



CAUTION

Use only 20mm long T-bolts when mounting Module Level Power Electronics (MLPE) to top of rail. Place the MLPE in a location on the rail that reduces the risk of contact with the module back sheet under load.

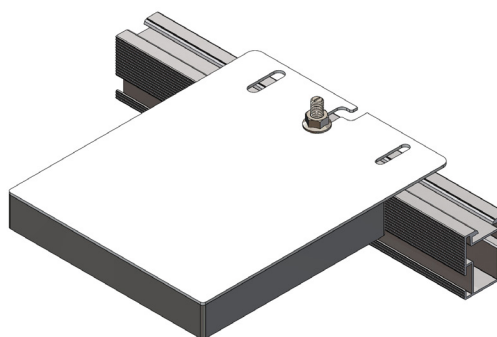

Image 6.1.3
MLPE mounted to QRail with T-bolt.

6.2 Installing Clamps w/ QClick Technology®

Quick Mount PV's patented QClick Technology is a special clip with which the module clamps are fastened in the QRail. You need only a ½" or 13mm socket for the installation. The QClick is inserted from above into the top channel of the QRail.

Installation Steps:

- Insert the QClick at a slight angle into the rail channel.
- While holding it firmly in place, rock the QClick upright until it clicks into place. (Do not squeeze the QClick.)

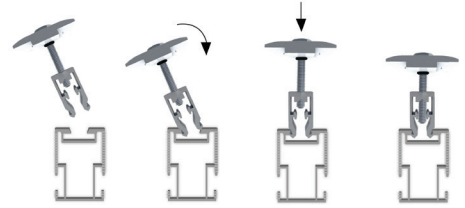

Image 6.2.1
Installation of clamps w/ QClick Technology

Removing the Clamps w/ QClick:

Spreaders on the inside of the QClick are designed so that once the bolt of the clamp has been tightened, the QClick cannot unlatch from the rail.

To remove a QClick, first unscrew the bolt so that it is clear of the spreaders then, with pressure on one of the QClick "legs," rock the QClick to unlatch it from the rail and lift it out.

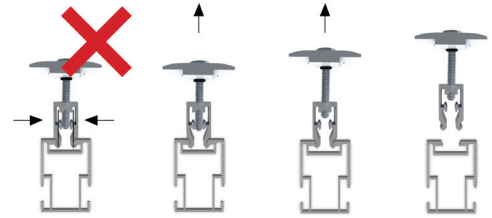

Image 6.2.2
Removing clamps w/ QClick Technology

Moving the Clamps w/ QClick:

The shape of the QClick corresponds exactly to the profile of the rail channel. To move the QClick, press lightly on the base of the QClick legs and slide the QClick along the channel.

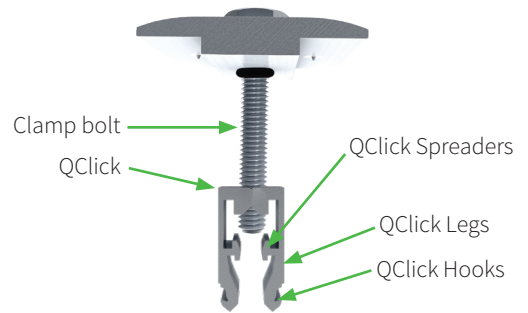

Image 6.2.3
QClick Components



DANGER

The outside edge of the QClick must be installed at least ½" from end or rail at a splice location.



CAUTION

Material damage caused by deformed QClicks

If clearly deformed QClicks are used, the safety of the module attachment is not assured. PV modules can fall and be damaged. Use only QClick where the legs are parallel to each other and you can clearly hear them clicking into the rail channel. Replace the deformed QClick prior to installation.

6.3 Installing the End Modules

The end modules of the PV system are fastened on the outer side with two module end clamps each. Three types of module end clamps are available from Quick Mount PV. Fixed end clamps are sized to fit a particular module thickness and will not work on modules of other thicknesses. Hidden End Clamps (P/N QMR-HEC-A-20) will work on almost all modules with a flange in the acceptable clamping zone. Universal end clamps are designed to fit 2 ranges of module thicknesses. Universal end clamps are available in either mill or black finish in the following size ranges:

Part Number	Finish	Clamping Range (mm)
QMR-UEC3045-A-20	mill	30-45
QMR-UEC3045-B-20	black	30-45

Mounting Steps, Fixed Height End Clamps:

- Place and align an outside module. The QRail must extend beyond the module frame by a minimum of 1.2 in.
- Insert the QClick of the end clamp into the channel of the QRail.
- Push the module end clamp flush to the module frame.
- Tighten the bolt to 8 ft-Lb (11 N-m), thus clamping the module.

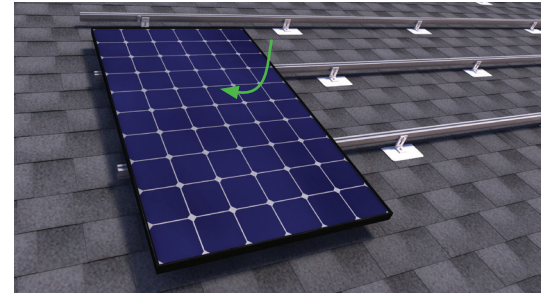

Image 6.3.1

Mounting steps, Universal End Clamps:

- Place and align an outside module. The QRail must extend beyond the module frame by 1.2 in. (30 mm).
- Insert the QClick of the end clamp flush against the module frame. The lip of the upper clamp body should be flush against the edge of the module.
- Ensure that the lower section of the clamp body sits squarely on the top of the rail.
- While holding the upper clamp body against the module and the lower clamp body, tighten the clamp bolt to 96 in-lbs (11 N-m).

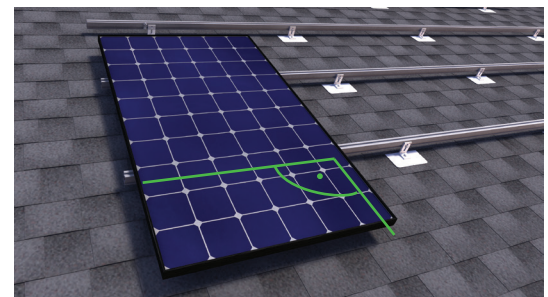

Image 6.3.2

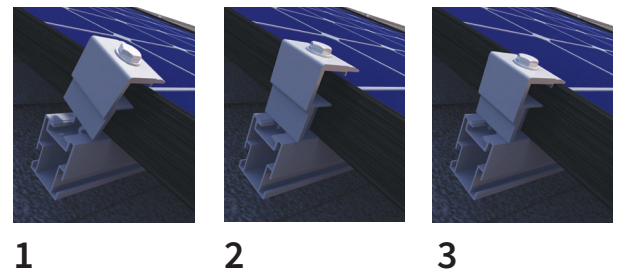

Image 6.3.3
End Clamp installation



DANGER

Material damage due to incorrect installation

Incorrectly mounted clamps are a hazard to the integrity of the PV system. PV modules can fall and be damaged. Mount all clamp connections in accordance with the instructions.

- Make sure the clamps are installed correctly.
- Ensure the module is installed flush and tight against the side of the end clamp.
- Ensure proper torque of the end clamp mounting bolt [96 in-lbs (11 N-m) for fixed height and universal end clamps or 108 in-lbs (12 N-m) for hidden end clamps].

Mounting Steps, Hidden End Clamps:

- After installation of rails and prior to installation of the modules slide the Hidden End Clamp into both sides approximately 4 inches from the end of the rail. See Image 6.3.4
- Install first module insuring the module frame is flush with the end of the rails. See Image 6.3.5
- Slide Hidden End Clamp over until it fully engages with the module flange. See Image 6.3.6
- Tighten Hidden End Clamp bolt to 9 ft-lbs (12 N-m). See Image 6.3.7
- At end of module row place final module in place (Do not tighten mid clamps) and mark the edge of the module on the rail and pick up module.
- Cut Rail at the marked location
- Replace module and tighten Mid Clamps
- Slide final Hidden End Clamp over to fully engage flange of the module
- Tighten Hidden End Clamp Bolt to 9 ft-lbs (12 N-m). Place End Caps onto rails

NOTE!

When working at steep pitches it may be advantageous to utilize Universal End Clamps while setting the module line. The Hidden End Clamp can be tightened once the line is set and the Universal End Clamp removed.

NOTE!

The QRail Hidden End Clamp is NOT a bonding solution and therefore cannot be used on single modules. It must always be installed in conjunction with at least one Bonding Mid Clamp.

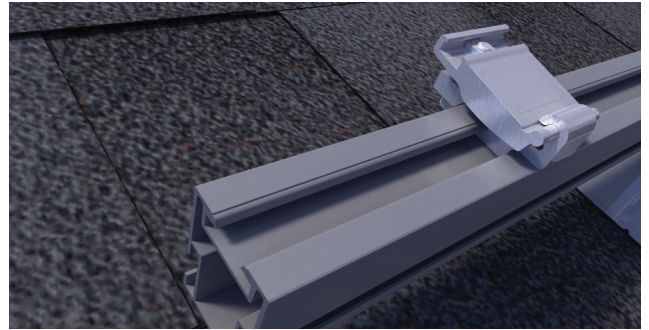

Image 6.3.4

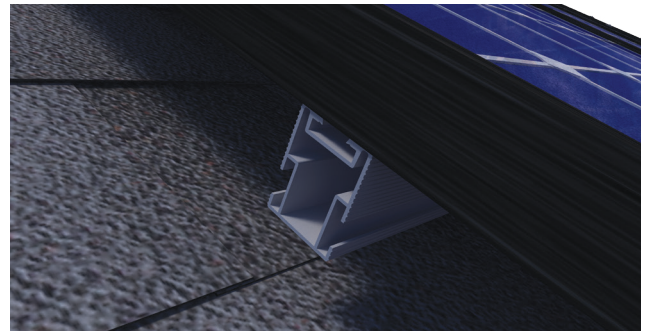

Image 6.3.5

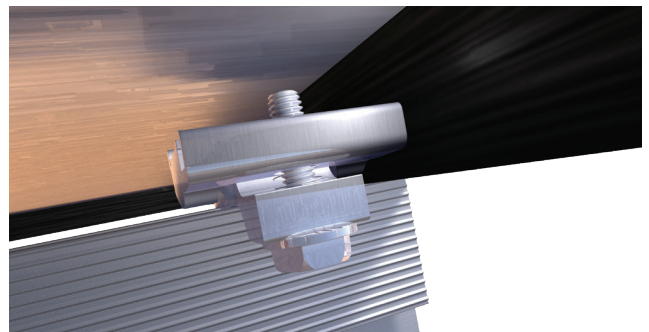

Image 6.3.6

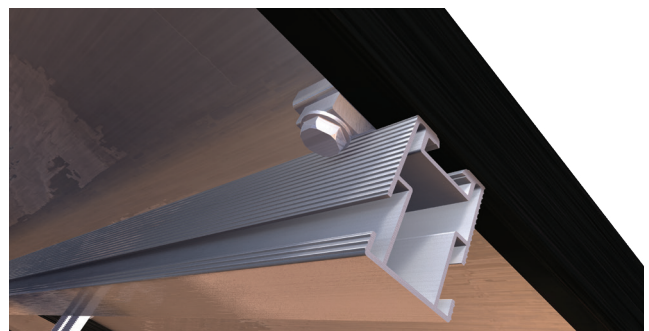

Image 6.3.7

6.4 Installing the Inner Modules

Inner modules of the array are secured with mid clamps. All mid clamps are provided with integral bonding. Mid clamps are designed to fit modules within a particular range. Mid clamps are available in either mill or black finish in the following size ranges:

Part Number	Finish	Clamping Range (mm)
QMR-UMC3045BP1.2 A 20	mill	30-45
QMR-UMC3045-B-20	black	30-45

Table 6.4.1

Mounting steps:

- Insert the QClick of the mid clamp into the QClick channel of the rail. The flat sides of the QClick make it possible to install the QClick flush against the module side.
- Slide the module clamp flush against the side of the module by pushing the clamp against the side of the module.
- Slide the next module under the clamp head and flush against the QClick body.
- Using a ½" or 13mm socket, tighten the clamp bolt onto the modules. Tighten the clamp bolt to 144 in-lbs (16 N-m).



DANGER

Material damage due to incorrect mounting

Incorrectly mounted modules can fall and become damaged

- Make sure the clamps are installed correctly.
- Ensure the module is installed flush and tight against the side of the mid clamp.
- Ensure proper torque of the mid clamp mounting bolt 144 in-lbs (16 N-m).

NOTE!

Mid Clamps have been tested and approved for multiple use per ANSI/UL-2703 Edition 1.

6.5 Installing Additional Module Rows

Mounting steps:

- Additional module rows are by repeating steps in sections 6.1-6.4.

NOTE!

Use of a spare module clamp QClick or other item as a spacing gauge between the top of one row of modules and the bottom of another can help provide a neat, aesthetically pleasing array.



Image 6.4.1
Inner module installation step 1

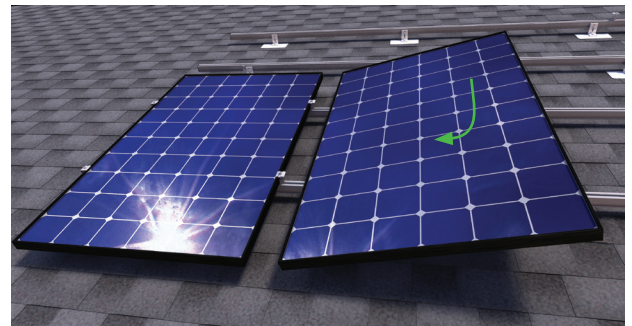
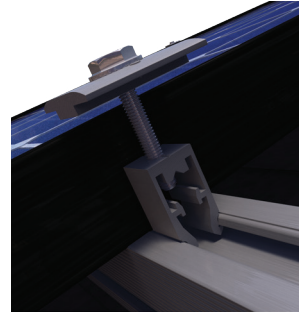

Image 6.4.2
Inner module installation step 2

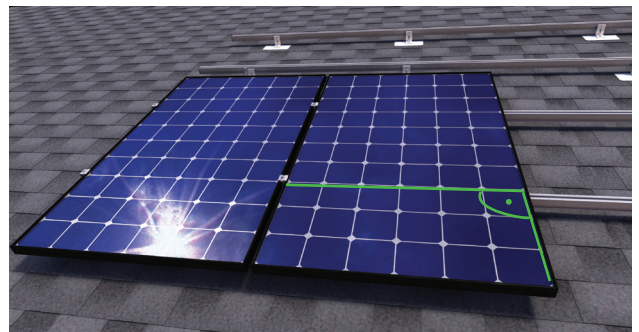

Image 6.4.3
Inner module installation step 3

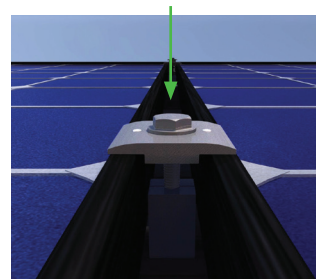

Image 6.4.4
Tighten clamp bolt
[144 in-lbs (16 N-m)]



DANGER

Material damage due to incorrect mounting

Incorrectly fastened modules can fall and become damaged.

- Make sure the QClicks click in securely
- Ensure the modules are flush against both sides of the clamp.
- Observe and adhere to the recommended torque specifications

7. Maintenance

When properly assembled, the QRail is a reliable and trouble-free system and should require little in the way of ongoing maintenance or repair. Nevertheless, Quick Mount PV recommends maintaining a regular inspection and maintenance schedule. Such a program can detect and address potential problems before they become serious and help ensure the system's excellent long-term durability and reliability.

The following procedure pertains only to the QRail mounting system structure. Maintenance and repair of other PV system components should be carried out in accordance with the respective manufacturers' recommendations.

7.1 Inspection

The system should be visually inspected periodically for loose components, loose fasteners, and any corrosion. If any of these conditions are found, the affected components should be immediately adjusted, repaired, or replaced.

7.2 Testing

After one year in service, it is a good practice to check the torque settings of a representative sample of system connections, including module clamps and rail clamps. If a disproportionate number of loose connections (more than 10% of connections) are found, it may be an indication of improper assembly and it may be necessary to take comprehensive corrective action.

A smaller sampling of connections can be tested annually thereafter. Quick Mount PV recommends keeping records of the connections sampled each year and testing and, if necessary, adjusting previously untested connections in succeeding years. After all connections have been tested, sample sizes and test frequency can be reduced.

8. List of UL Tested and/or Evaluated PV Modules

The Qrail system may be used to ground and/or mount UL1703 or UL 61730 listed PV module only when the specific module has been evaluated for grounding and/or mounting under UL 2703 and in compliance with the included instructions. Unless otherwise noted, “xxx” refers to the module power rating and both black and silver frames are included in the certification. Review module and any 3rd party manufacturer’s documentation for compatibility and compliance with warranty terms and conditions.

Manufacturer	Model Number
Adani	Adani modules with 35 and 40mm frames ASX-Y-ZZ-xxx Where "X" can be B, M or P, "Y" can be 6 or 7, and "ZZ" can be blank, PERC, B-PERC, or AB-PERC
Amerisolar	Amerisolar modules with 35, 40 and 50 mm frames AS-byxxxZ Where "b" can be 5 or 6; "Y" can be M, P, M27, P27, M30, or P30; and "Z" can be blank, W or WB
Aptos Solar	Aptos modules with 35 and 40 mm frames DNA-yy-zz23-xxx Where "yy" can be 120 or 144; and "zz" can be MF or BF
Astronergy Solar	Astronergy modules with 30, 35, 40, and 45 mm frames aaSMbbyC/zz-xxx Where "aa" can be CH or A; "bb" can be 60, 66, or 72; "yy" can be blank, 10 or 12; "C" can be M, P, M(BL), M-HC, M(BL)-HC, P-HC, M(DG), or M(DGT); and "zz" can be blank, HV, F-B, or F-BH
ASUN	ASUN modules with 35 and 40 mm frames ASUN-xxx-YYZZ-aa Where "YY" can be 60 or 72; "ZZ" can be M, or MH5; and "aa" can be blank or BB
Auxin	Auxin modules with 40 mm frames AXN6y6zAxxx Where "y" can be M or P; "z" can be 08, 09, 10, 11, or 12; and "A" can be F or T
Axitec	Axitec Modules with 35 and 40 mm frames AC-xxxY/aaZZb Where "Y" can be M, P or MH; "aa" can be blank, 125- or 156-; "ZZ" can be 54, 60, 72, 120, or 144; "b" can be S, X, V, XV, or MX
Boviet	Boviet modules with 35 and 40mm frames BVM66aaYY-xxxBcc Where "aa" can be 9, 10 or 12; "YY" is M or P; and "B" can be blank, L or S; and "cc" can be blank, H, H-BF, H-HC, HC-BF or H-HC-BF
BYD	BYD modules with 35 mm frames BYDxxxAY-ZZ Where "A" can be M6, P6, MH or PH; "Y" can be C or K; and "ZZ" can be 30 or 36

Manufacturer**Model Number**

Canadian Solar	Canadian Solar modules with 30, 35 and 40 mm frames CSbY-xxxZ Where "b" can be 1, 3 or 6; "Y" can be H, K, L, N, P, U, V, W, X or Y; and "Z" can be M, P, MS, PX, M-SD, P-AG, P-SD, MB-AG, PB-AG, MS-AG, or MS-SD
CertainTeed	CertainTeed modules with 35 and 40 mm frames CTxxxYZZ-AA Where "Y" can be M, P, or HC; "ZZ" can be 00,01, 10, or 11; and "AA" can be 01, 02, 03, or 04
CSUN	Csun modules with 35 and 40 mm frames YYxxx-zzAbb Where "YY" is CSUN or SST; "zz" is blank, 60, or 72; and "A" is blank, P or M; "bb" is blank, BB, BW, or ROOF
Dehui	Dehui modules with 35 and 40mm frames DH-MYYYZ-xxx Where "YYY" can be 760, 772, 860, 872; and "Z" can be B or W
Ecosolargy	Ecosolargy modules with 35, 40, and 50 mm frames ECOxxxYzzA-bbD Where "Y" can be A, H, S, or T; "zz" can be 125 or 156; "A" can be M or P; "bb" can be 60 or 72; and "D" can be blank or B
ET Solar	ET Solar modules with 35, 40, and 50 mm frames ET-Y6ZZxxxAA Where "Y" can be P, L, or M; "ZZ" can be 60 or 72 or 72BH; and "AA" can be WB, WW, BB, WBG, WWG, WBAC, WBCO, WWCO, WWBCO or BBAC
Flex	Flex modules with 35, 40, and 50 mm frames FXS-xxxYY-ZZ; Where "YY" can be BB or BC; and "ZZ" can be MAA1B, MAA1W, MAB1W, SAA1B, SAA1W, SAC1B, SAC1W, SAD1W, SBA1B, SBA1W, SBC1B, or SBC1W
GCL	GCL modules with 35 mm and 40 mm frames GCL-ab/YY xxx Where "a" can be M or P; "b" can be 3 or 6; and "YY" can be 60, 72, 72H, or 72DH
GigaWatt Solar	Gigawatt modules with 40 mm frames GWxxxYY Where "YY" can be either PB or MB
Hansol	Hansol modules with 35 and 40 mm frames HSxxxYY-zz Where "YY" can be PB, PD, PE, TB, TD, UB, UD, or UE; and "zz" can be AH2, AN1, AN3, AN4, HH2, HV1, or JH2
Hanwha Solar	Hanwha Solar modules with 40, 45, and 50 mm frames HSLaaP6-YY-1-xxxZ Where "aa" can be either 60 or 72; "YY" can be PA or PB; and "Z" can be blank or B

Manufacturer

Model Number

<p>Hanwha Q CELLS</p>	<p>Hanwha Q CELLS Modules with 32, 35, 40, and 42 mm frames aaYY-ZZ-xxx where "aa" can be Q. or B.; "YY" can be PLUS, PRO, PEAK, LINE PRO, LINE PLUS, PLUS DUO or PEAK DUO; and "ZZ" can be G3, G3.1, G4, G4.1, L-G2, L-G2.3, L-G3, L-G3.1, L-G3y, L-G4, L-G4.2, L-G4y, LG4.2/TAA, BFR-G3, BLK-G3, BFR-G3.1, BLK-G3.1, BFR-G4, BFR-G4.1, BFR G4.3, BLK-G4.1, G4/SC, G4.1/SC, G4.1/TAA, G4.1/MAX, BFR G4.1/TAA, BFR G4.1/MAX, BLK G4.1/TAA, BLK G4.1/SC, EC-G4.4, G5, G5/SC, G5/TS, BLK-G5, BLK-G5/SC, BLK-G5/TS, L-G5, L-G5.1, L-G5.2, L-G5.2/H, L-G5.3, G6, G6/SC, G6/TS, G6+, BLK-G6, L-G6, L-G6.1, L-G6.2, L-G6.3, G7, BLK-G6+, BLK-G6+/AC, BLK-G6+/SC, BLK-G6/TS, G6+/TS, BLK-G6+/TS, BLK-G7, G7.2, G8, BLK-G8, G8+, BLK-G8+ L-G7, L-G7.1, L-G7.2, L-G7.3, L-G8, L-G8.1, L-G8.2, L-G8.3, L-G8.3/BFF, ML-G9, BLK ML-G9, ML-G9+, BLK ML-G9+, XL-G9, XL-G9.2 or XL-G9.3</p>
<p>Heliene</p>	<p>Heliene modules with 40 mm frames YYZZxxxA Where "YY" can be 36, 60, 72, or 96; "ZZ" can be M, P, or MBLK; and "A" can be blank, HomePV, or Bifacial</p>
<p>HT-SAAE</p>	<p>HT-SAAE modules with 35 and 40 mm frames HTyy-156Z-xxx Where "yy" can be 60 or 72, "Z" can be M, P, M-C, P-C, M(S), M(VS), M(V), P(V), M(V)-C, P(V)-C</p>
<p>Hyundai</p>	<p>Hyundai modules with 33, 35, 40 and 50 mm frames HiY-SxxxZZ Where "Y" can be A, D, M or S; and "ZZ" can be HG, HI, KI, MI, MF, MG, PI, RI, RG, RG(BF), RG(BK), SG, TI, or TG</p>
<p>Itek</p>	<p>Itek Modules with 40 and 50 mm frames IT-xxx-YY Where "YY" can be blank, HE, or SE, or SE72</p>
<p>JA Solar</p>	<p>JA Solar modules with 30, 35, 40 and 45 mm frames JAyyzz-bbww-xxx/aa Where "yy" can be M, P, M6 or P6; "zz" can be blank, (K), (L), (R), (V), (BK), (FA), (TG), (FA)(R), (L)(BK), (L)(TG), (R)(BK), (R)(TG), (V)(BK), (BK)(TG), or (L)(BK)(TG); "bb" can be 48, 60, or 72; "ww" can be D09, S01, S02, S03, S06, S09, S10, or S12; and "aa" can be BP, MR, SI, SC, PR, 3BB, 4BB, 4BB/RE, 5BB</p>
<p>Jinko</p>	<p>Jinko modules with 35 and 40 mm frames JKMYxxxZZ-aa Where "Y" can either be blank or S; "ZZ" can be M, P, or PP; and "aa" can be blank, 60, 60B, 60H, 60L, 60BL, 60HL, 60HB, 60HBL, 6HBL-EP, 60-J4, 60B-J4, 60B-EP, 60(Plus), 60-V, 60-MX, 6RL3-B, 6TL3-B, 7RL3-V, 7RL3-TV, 72, 72B, 72-J4, 72B-J4, 72(Plus), 72-V, 72H-V, 72L-V, 72HL-V, 72-MX, 72H-BDVP, 72HL-TV, or 72HL-V-MX3</p>

Manufacturer**Model Number**

Kyocera	<p>Kyocera Modules with 46mm frames KYxxxZZ-AA Where "Y" can be D or U; "ZZ" can be blank, GX, or SX; and "AA" can be LPU, LFU, UPU, LPS, LPB, LFB, LFBS, LFB2, LPB2, 3AC, 3BC, 3FC, 4AC, 4BC, 4FC, 4UC, 5AC, 5BC, 5FC, 5UC, 6BC, 6FC, 8BC, 6MCA, or 6MPA</p>
LG	<p>LG modules with 35, 40, and 46 mm frames LGxxxYaZ-bb Where "Y" can be A, E, M, N, Q, S; "a" can be A, 1 or 2; "Z" can be C, K, T, or W; and "bb" can be A3, A5, A6, B3, B6, E6, G3, G4, J5, K4, L5, N5, or V5</p>
Longi	<p>Longi modules with 30, 35 and 40 mm frames LRa-YYZZ-xxxM Where "a" can be 4 or 6; "YY" can be blank, 60 or 72; and "ZZ" can be blank, BK, BP, HV, PB, PE, PH, HBD, HIB, HII, HPB, HPH, or HIBD</p>
Mission Solar	<p>Mission Solar modules with 33 and 40 mm frames MSEbbxxxZZaa Where "bb" can be blank or 60A; "ZZ" can be blank, MM, SE, SO, SQ, SR, or TS; and "aa" can be blank, 1J, 4J, 4S, 5K, 5T, 60, 6J, 6S, 6W, 8K, 8T, or 9S</p>
Mitsubishi	<p>Mitsubishi modules with 46 mm frames PV-MYYxxxZZ Where "YY" can be LE or JE; and "ZZ" can be either HD, HD2, or FB</p>
Motech	<p>IM and XS series modules with 40, 45, and 50 mm frames</p>
Next Energy Alliance	<p>Next Energy Alliance modules with 35 and 40mm frames yyNEA-xxxZZ where "yy" can be blank or US; "ZZ" can be M, MB or M-60</p>
Neo Solar Power	<p>Neo Solar Power modules with 35 mm frames D6YxxxZZaa Where "Y" can be M or P; "ZZ" can be B3A, B4A, E3A, E4A, H3A, H4A; and "aa" can be blank, (TF), ME or ME (TF)</p>
Panasonic (HIT)	<p>Panasonic modules with 35 and 40 mm frames VBHNxxxYyzzA Where "YY" can be either KA, RA, SA or ZA; "zz" can be either 01, 02, 03, 04, 06, 06B, 11, 11B, 15, 15B, 16, 16B, 17, or 18; and "A" can be blank E, G or N</p>
Panasonic (EverVolt)	<p>Panasonic modules with 30 mm frames EVPVxxxA Where "A" can be blank or K</p>
Peimar	<p>Peimar modules with 40 mm frames SbxxxYzz Where "b" can be G, M or P; "Y" can be M or P; and "zz" can be blank, (BF), or (FB)</p>

Manufacturer

Model Number

Philadelphia Solar	Philadelphia modules with 35 and 40 mm frames PS-YzzAA-xxx Where "Y" can be M or P; "zz" can be 60 or 72; and "AA" can be blank or (BF)
Phono Solar	Phono Solar modules with 35, 40, and 45 mm frames PSxxxY-ZZ/A Where "Y" can be M, M1, MH, or M1H or P; "ZZ" can be 20 or 24; and "A" can be F, T, U, or TH
Recom	Recom modules with 35 and 40 mm frames RCM-xxx-6yy Where "yy" can be MA, MB, ME or MF
REC Solar	REC modules with 30, 38 and 45 mm frames RECxxxYZZ Where "YY" can be AA, M, NP, PE, PE72, TP, TP2, TP2M, TP2SM, TP2S, TP3M; and "ZZ" can be blank, Black, BLK, BLK2, SLV, or 72
Renesola	ReneSola modules with 35, 40 and 50 mm frames AAxxxY-ZZ Where "AA" can be SPM(SLP) or JC; "Y" can be blank, F, M or S; and "ZZ" can be blank, Ab, Ab-b, Abh, Abh-b, Abv, Abv-b, Bb, Bb-b, Bbh, Bbh-b, Bbv, Bbv-b, Db, Db-b, or 24/Bb
Renogy	Renogy Modules with 40 and 50 mm frames RNG-xxxY Where "xxx" is the module power rating; and "Y" can be D or P
Risen	Risen Modules with 35 and 40 mm frames RSMyy-6-xxxZZ Where "yy" can be 60, 72, 120, 132 or 144; and "ZZ" can be M, P
S-Energy	S-Energy modules with 35 and 40mm frames SABB-CCYY-xxxZ Where "A" can be C, L or N; "BB" can be blank, 20, 40 or 45; "CC" can be blank, 60 or 72; "YYY" can be blank, MAE, MAI, MBE, MBI, MCE or MCI; and "Z" can be V, M-10, P-10 or P-15
Seraphim Energy Group	Seraphim modules with 35 and 40 mm frames SEG-aYY-xxxZZ Where "a" can be blank, 6 or B; "YY" can be blank, MA, MB, PA, or PB; and "ZZ" can be blank, BB, BG, BW, HV, WB, WW, BMB, BMA-HV, BMB-HV
Seraphim USA	Seraphim modules with 40 and 50 mm frames SRP-xxx-6YY-ZZ Where "xxx" is the module power rating; and "YY" can be MA, MB, PA, PB, QA-XX-XX, and QB-XX-XX; ZZ is blank, BB or HV

Manufacturer**Model Number**

Sharp	Sharp modules with 35 and 40 mm frames NUYYxxx Where "YY" can be SA or SC
Silfab	Silfab Modules with 38 mm frames SYY-Z-xxxAb Where "YY" can be IL, SA, LA, SG or LG; "Z" can be blank, M, P, or X; "A" can be blank, B, H, M, N; and "b" can be A, L, G, K or T
Solaria	Solaria modules with 40 mm frames PowerXT xxxY-ZZ Where "Y" can be R or C; and "ZZ" can be AC, BD, BX, BY, PD, PM, PM-AC, PX, PZ, WX or WZ
Solarcity (Tesla)	Solarcity modules with 40 mm frames SCxxxYY Where "YY" can be blank, B1 or B2
SolarTech	SolarTech modules with 42 mm frames STU-xxxYY Where "YY" can be PERC or HJT
SolarWorld AG	SolarWorld Sunmodule Plus, Protect, Bisun, XL, Bisun XL, may be followed by mono, poly, duo, black, bk, or clear; modules with 31, 33 or 46 mm frames SW-xxx
SolarWorld Americas	SolarWorld Sunmodule Plus, Protect, Bisun, XL, Bisun XL, may be followed by mono, poly, duo, black, bk, or clear; modules with 33 mm frames SWA-xxx
Sonali	Sonali Modules with 40 mm frames SSxxx
Stion	Stion Thin film modules with 35 mm frames STO-xxx or STO-xxxA
SunEdison	SunEdison Modules with 35, 40 & 50 mm frames SE-YxxxZABCDE Where "Y" can be B, F, H, P, R, or Z; "Z" can be 0 or 4; "A" can be B,C,D,E,H,I,J,K,L,M, or N ; "B" can be B or W; "C" can be A or C; "D" can be 3, 7, 8, or 9; and "E" can be 0, 1 or 2
Suniva	Suniva modules with 35, 38, 40, 46, and 50 mm frames OPTxxx-AA-B-YYY-Z MVXxxx-AA-B-YYY-Z Where "AA" is either 60 or 72; "B" is either 4 or 5; "YYY" is either 100,101,700,1B0, or 1B1; and "Z" is blank or B
Sunpower	Sunpower standard (G3 or G4) or InvisiMount (G5) 40 and 46 mm frames SPR-Zb-xxx-YY Where "Z" is either A, E, P or X; "b" can be blank, 17, 18, 19, 20, 21, or 22; and "YY" can be blank, BLK, COM, C-AC, D-AC, E-AC, BLK-E-AC, G-AC, BLK-C-AC, or BLK-D-AC

Manufacturer

Model Number

Sunspark	Sunspark modules with 40 mm frames SYY-xxxZ-A Where “YY” can be MX or ST; and “Z” can be M, MB, M3, M3B, P or W; and “A” can be 60 or 72
Suntech	Suntech Modules with 35, 40 and 50mm frames STPxxxz-aa Where “y” is blank or S; and “zz” can be 20, 24, A60 or A72U; and “aa” can be Vd, Vem, Vfw, Vfh, Wdb, Wde, Wd, or Wfhb
Talesun	Talesun modules with 35 and 40mm frames TP6yZZaaxxx-b Where “y” can be blank, F, H, or L; “ZZ” can be 60 or 72; “aa” can be M, M(H), or P; and “b” can be blank, B, T, or (H)
Trina	Trina Modules with 30, 35, 40 and 46mm frames TSM-xxxYYZZ Where “YY” can be DD05, DD06, DD14, DE14, DE15, DEG15, PA05, PC05, PD05, PD06, PA14, PC14, PD14, PE14, or PE15 ; and “ZZ” can be blank, .05, .08, .10, .18, .08D, .18D, 0.82, .002, .00S, 05S, 08S, A, A.05, A.08, A.10, A.18, A(II), A.05(II), A.08(II), A.082(II), A.10(II), A.18(II), H, H(II), H.05(II), H.08(II), HC.20(II), HC.20(II), M, M(II), M.05(II), MC.20(II)
URE	URE modules with 35 mm frames DyZxxxHaa Where “y” can be 6 or 7; “Z” can be K or M; and “aa” can be H3A, H4A, or H8A
Vikram	Vikram solar modules with 40 mm frames VSyy.ZZ.AAA.bb Where “yy” can be M, P, MBB, MH, MS, MHBB, or PBB; “ZZ” can be 60 or 72; “AAA” is the module power rating; and “bb” can be 03, 04 or 05
VSUN	VSUN modules with 35 and 40 mm frames VSUNxxx-YYz-aa Where “YY” can be 60, 72, 120, or 144; “z” can be M, P, MH, PH, or BMH; and “aa” can be blank, BB or BW
Waaree	Waaree modules with 40mm frames WSyy-xxx where “yy” can be blank, or M
Winaico	Winaico modules with 35 and 40 mm frames Wsy-xxxZa Where “y” can be either P or T; “Z” can be either M, P, or MX; and “a” can be blank or 6
Yingli	Panda, YGE, YGE-U, and YLM series modules with 35, 40, and 50 mm frames

Quick Mount PV[®]

RESPECT THE ROOF



Intertek

Conforms to
UL STD 2703

