

ITEM NO	DESCRIPTION	QTY IN KIT
1	CAP SCREW, 5/16" X 1" W/ 1" CAPTIVE WASHER	1
2	WASHER, EPDM BACKED	1
3	POST, 1-1/4" X 6-1/2"	1
4	QBASE, 1-1/4"	1
5	CAP SCREW, HEX HEAD, 5/16" X 3/4"	1

PART NUMBER	DESCRIPTION	MOUNT HEIGHT
QM-QBB-01-M1	Qbase Base (incl. base to post h/w), Mill	na
QM-QBP-3.25-M1	Qbase 3.25" Post (incl. post to rack h/w), Mill	3.75"
QM-QBP-4.5-M1	Qbase 4.5" Post (incl. post to rack h/w), Mill	5"
QM-QBP-6.5-M1	Qbase 6.5" Post (incl. post to rack h/w), Mill	7"
QM-QBP-8.5-M1	Qbase 8.5" Post (incl. post to rack h/w), Mill	9"
QM-QBP-11.5-M1	Qbase 11.5" Post (incl. post to rack h/w), Mill	12"
QM-QBP-12.5-M1	Qbase 12.5" Post (incl. post to rack h/w), Mill	13"
QM-QBP-14.5-M1	Qbase 14.5" Post (incl. post to rack h/w), Mill	15"
QM-QBP-17.5-M1	Qbase 17.5" Post (incl. post to rack h/w), Mill	18"

1) CAP SCREW, 5/16" X 1" W/ 1" CAPTIVE WASHER

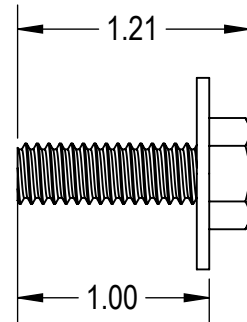
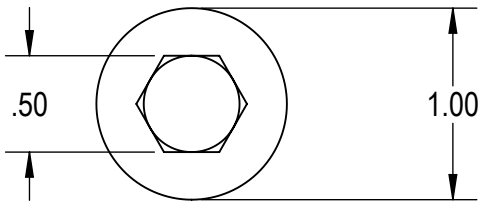

Property	Value
Material	300 Series Stainless Steel
Finish	Clear

2) WASHER, EPDM BACKED

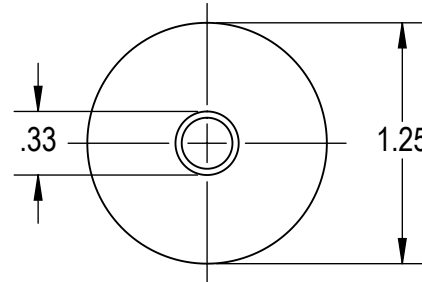
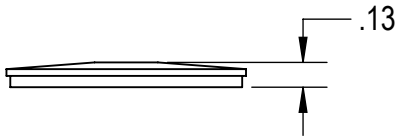

Property	Value
Material	300 Series Stainless Steel
Finish	Clear

3) POST, 1-1/4" X A

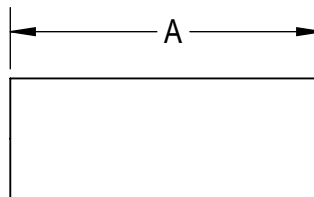
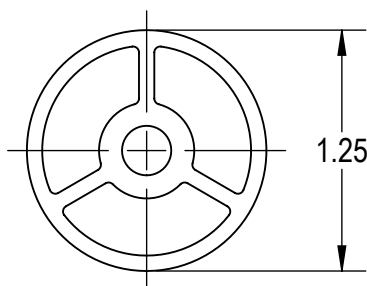

A
 POST LENGTHS AVAILABLE IN THE FOLLOWING SIZES:
 3.25", 4.5", 6.5", 8.5", 11.5",
 12.5", 14.5", 17.5"

Property	Value
Material	6000 Series Aluminum
Finish	Mill

4) QBASE, 1-1/4"

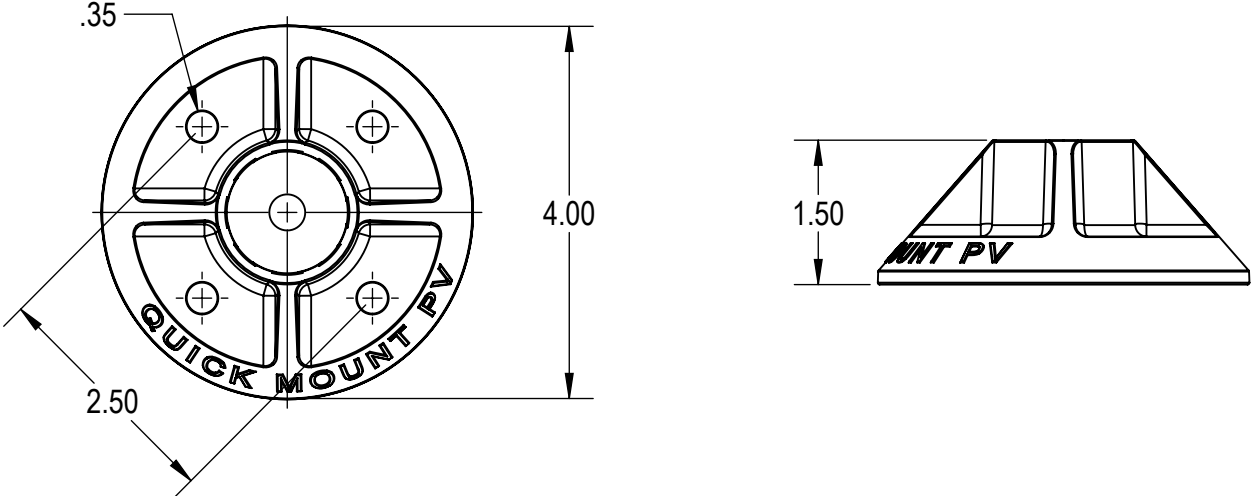

Property	Value
Material	A360 Aluminum
Finish	Mill

5) CAP SCREW, HEX HEAD, 5/16" X 3/4"



Property	Value
Material	300 Series Stainless Steel
Finish	Clear