



DC220-6 DEEP CYCLE

220AH @ 20Hr
6-Volt

Group Size: 27 (6V)

**Maintenance-Free
Sealed AGM Battery**

CYCLING CAPACITY

20 Hour Rate **220 Amp Hours**

RESERVE CAPACITY

Reserve @25 AMPS **425 Minutes** Reserve @75 AMPS **112 Minutes**

ELECTRICAL SPECIFICATIONS

Nominal Voltage	6 Volt
C100	242AH
C20	220AH
C10	198AH
C5	180AH
CCA	990
CA or MCA	1170
HPCA	2000 Amps
Internal Resistance	1.5m Ω

MECHANICAL SPECIFICATIONS

Group Size	27	
Terminal Type	M8	
Terminal Torque	See reverse side	
Height (w/ terminal)	8.90"	226mm
Height (case only)	8.66"	220mm
Width	6.85"	174mm
Length	12.05"	306mm
Weight	72.09 lbs.	32.7 kg
Case Type	ABS Plastic - Flame Res. Rating UL94-HB	

DISCHARGE TABLE (Constant Current)

Time	Amps	Rate
20hr	11.0	0.05CA
10hr	19.8	0.10CA
8hr	23.9	0.13CA
5hr	36.0	0.25CA
3hr	49.8	0.33CA
2hr	67.3	0.50CA
1hr	125	1.00CA

DISCHARGE PROFILE (Constant Current)

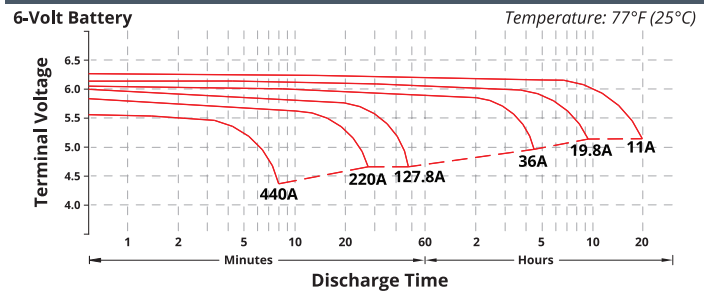

- All listed ratings are @ 100% SoC, T=77°F (25°C), 1.75VPC unless otherwise specified.

- Specifications listed are for estimation purposes only. Battery performance can vary depending on application. Battery design subject to change.

BATTERY & TERMINAL DIMENSIONS (All units shown in mm)

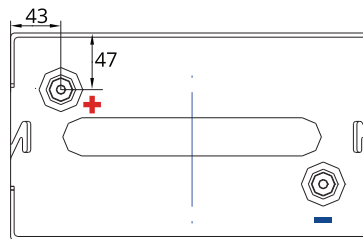
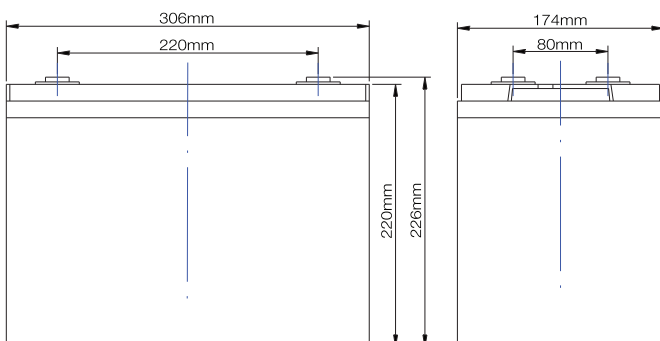

**Battery bank spacing required,
12.5mm (1/2" inch) minimum**

Terminal: M8

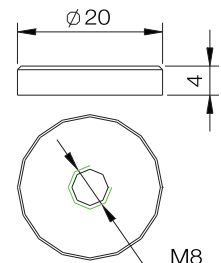

(unit: mm)

TEMPERATURE vs CAPACITY

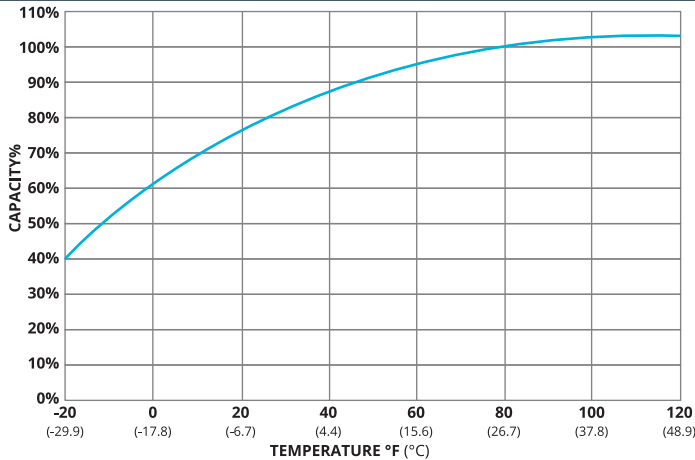

STATE of CHARGE (SOC) vs OPEN CIRCUIT VOLTAGE (OCV)

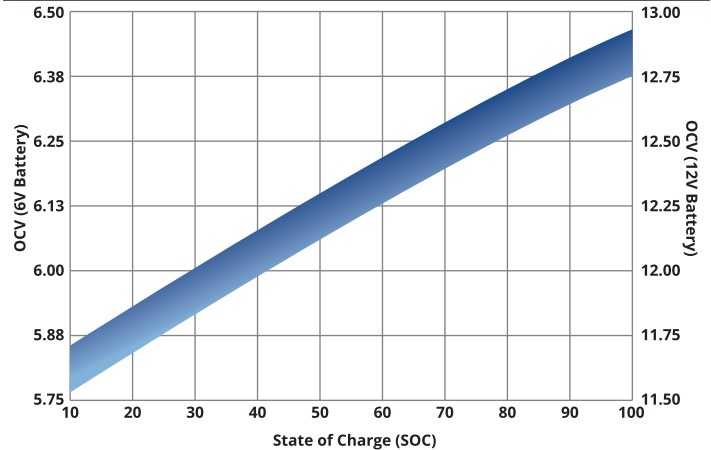

CYCLE LIFE vs DEPTH of DISCHARGE (DOD)

*(Based on BCI Testing @ 2-hr Rate)

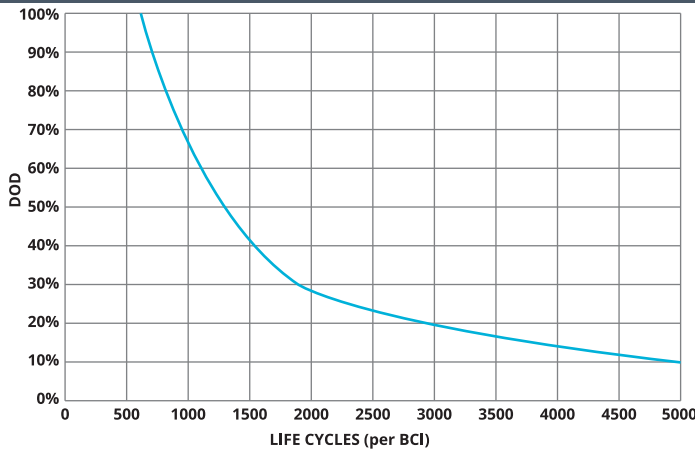

SELF DISCHARGE vs TIME/TEMPERATURE

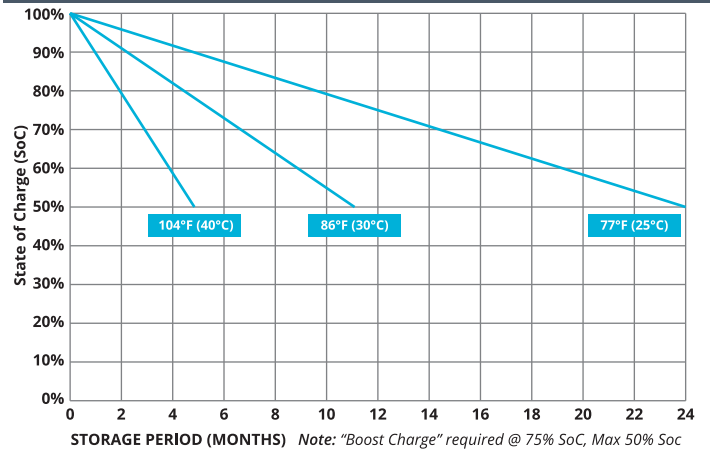

TEMPERATURE RANGE SPECIFICATIONS

Condition	Recommended	Maximum	Recommended	Maximum
Storage	5°F to 122°F	-40°F to 160°F	-15°C to 50°C	-40°C to 71°C
Operation	5°F to 104°F	-40°F to 160°F	-15°C to 40°C	-40°C to 71°C
Charge with TC	5°F to 122°F	-40°F to 160°F	-15°C to 50°C	-40°C to 71°C
Charge w/o TC	32°F to 104°F	5°F to 122°F	0°C to 40°C	-15°C to 50°C

*TC= Temperature Compensation

CHARGE VOLTAGES

Charge Stage	Battery Voltages			
	12V	24V	36V	48V
Bulk	14.7V	29.4V	44.1V	58.8V
Absorption	14.7V	29.4V	44.1V	58.8V
Float	13.6V	27.2V	40.8V	54.6V

TC Factor: (-2mV°F/cell) or (-4mV°C/cell)

TERMINAL TORQUE SPECS

Terminal Type	ft-lbs	in-lbs	Nm
AP, DT (AP), M6, M6M (Stud), TP07 (AP), TP08 (AP)	4.2 - 6.0	50-70	5.6 - 7.9
FR45	6.0 - 7.5	70-90	7.9 - 10.1
M8	7.1 - 8.0	85-95	9.6 - 10.7
DT (Stud), M10M (Stud)	9.2 - 10.4	110-125	12.2 - 14



9001:2008 Quality Management System
 14001:2004 Environmental Management System
 18001:2007 Occupational Health & Safety Management System



DELIVERY APPROVED!
**LAND, SEA
 & AIR**

Fullriver batteries are sealed lead acid batteries made with Absorbed Glass Mat (AGM) technology. The electrolyte is absorbed into the fiberglass separator material rather than in a free-flowing liquid form. Fullriver batteries are non-spillable electric storage batteries. They are exempted from the requirements of DOT's hazardous materials regulations, since they adhere to the requirements of code 49 CFR Section 173.159(D) - (CLASSIFIED APPROVED: DOT, CFR, HMR49, IATA, ICAO67, IMDG27)