

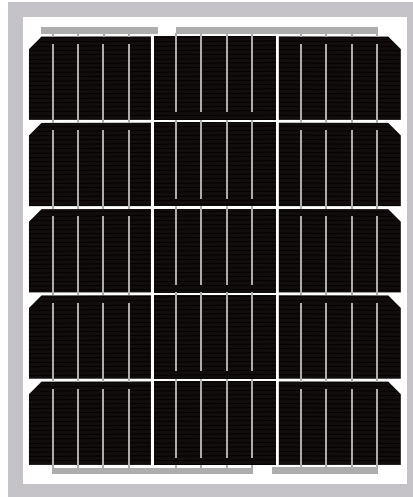

# ST-15P-06

## High Efficiency Monocrystalline PV Module

- Nominal 6V DC for standard output.
- Outstanding low-light performance.
- Heavy-duty anodized frames.
- High transparent low-iron, tempered glass.
- Designed to withstand high wind pressures, hail and heavy snow.
- Quality aesthetic appearance.



**15 CELL**  
MONOCRYSTALLINE MODULE

**15W**  
POWER OUTPUT

**20.00%**  
MODULE EFFICIENCY

**5%**  
POSITIVE TOLERANCE



### High Efficiency

Module Efficiency improved through advanced cell technology and manufacturing capabilities



### High PID Resistance

Advanced cell technology and qualified materials lead to high resistance to PID



### Withstands Harsh Environment

High PID resistance, 5400 Pa positive load, 2400 Pa negative load, Salt mist (IEC 61701)

## Performance Warranty

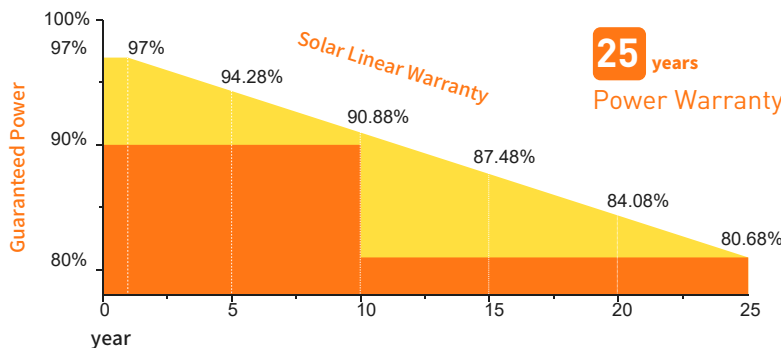

**2** years  
Product Warranty

**25** years  
Power Warranty

Wind Load/Snow Load:  
2400pa/5400pa

Positive Power Tolerance:  
0~+5W

Warranty Information:  
2 Year Product Workmanship

## Electrical Characteristics

Product code	015P1501A
Maximum power (Pmax)	15W
Voltage at Pmax (Vmp)	8.83V
Current at Pmax (Imp)	1.70A
Open-circuit voltage (Voc)	10.12V
Short-circuit current (Isc)	1.79A
Temperature coefficient of Voc	-(80±10)mV/°C
Temperature coefficient of Isc	(0.065±0.015)%/°C
Temperature coefficient of power	-(0.5±0.05)%/°C
NOCT (Air 20°C; Sun 0.8kW/m² wind 1m/s)	47±2°C
Operating temperature	-40°C to 85°C
Maximum system voltage	1000V DC
Power tolerance	± 5%

\*STC: Irradiance 1000W/m², AM1.5 spectrum, module temperature 25°C  
 \*NOCT: Nominal operating cell temperature (the data is only for reference)

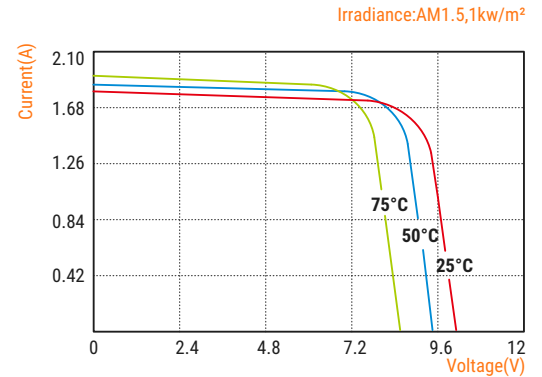

I-V Curves (STC)

## Specifications

Cells	Monocrystalline silicon solar cell
No. of cells and connections	15(3X5)
Module dimension	12.99in.x10.83in.x1.18in.[330mmx275mmx30mm]
Weight	2.75lbs[1.25kg]
Packing information(Carton)	14.76in.x12.60in.x2.56in.[375mmx320mmx65mm]/(1pc/ctn)

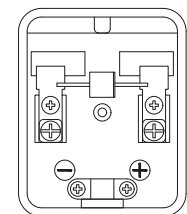
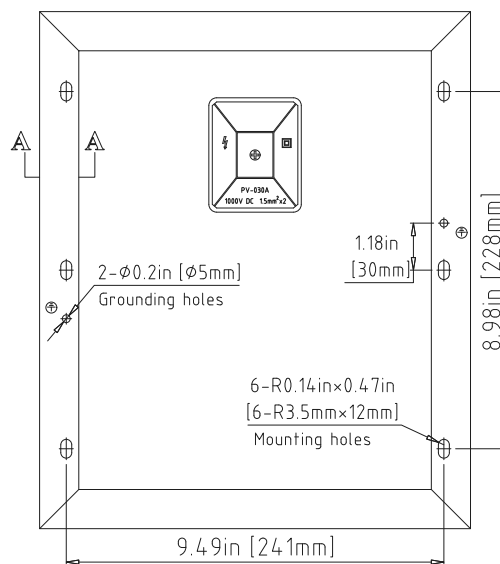
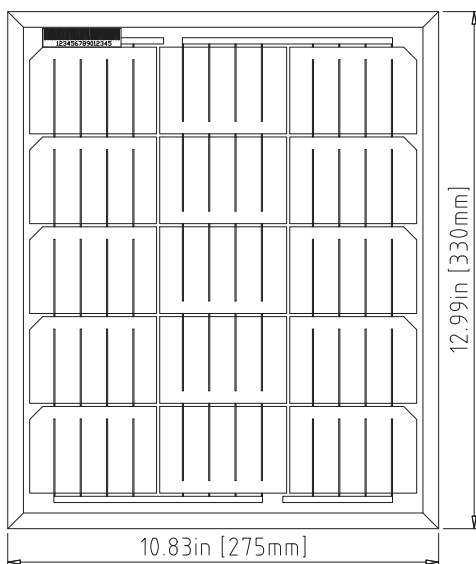

Junction Box Top View (Lid Open)

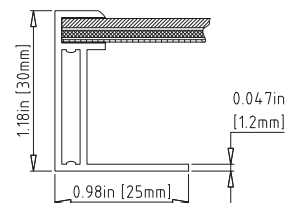

Section A-A