



POWERED BY

Dragonfly Model BBGC3 BBGC3H



Manual and Installation Guide

Dragonfly Energy Corp.

Please read this manual prior to installation and use.

Thank you for investing in a Battle Born Batteries system and welcome to the Battle Born Batteries family. This manual provides important information on how to install, operate, and care for your Battle Born Batteries. If you have purchased with us before, you will find this manual useful as a reference tool. If this is your first purchase with Battle Born Batteries, this manual can serve as an educational tool on how to properly use and care for your investment.

If you have a heat-enabled model, please refer to the additional Heat-Enable Instruction manual prior to use and installation.

Table of Contents

What is in the Box?.....	3
What Do I Need for Installation?	3
Connecting Load Specified Cables to the Batteries.....	3
Safety	4
How to Properly Charge the Batteries.....	4
Connecting the Batteries in Parallel	5
Connecting the Batteries in Series.....	6
How does the BMS Protect the Batteries	7
Voltage vs. Capacity	8
How to Properly Size Cables for System Install	8
How to Incorporate Fuses Into System Install	9
How to Properly Store Batteries	9
How to Maintain the Batteries	9
How to Properly Recycle and Dispose of the Batteries	9
Limited Warranty	9
Return Policy.....	9
Refund Policy	11
Shipping	11
Lithium-ion vs. Lead Acid	11
Recommended Accessories	12

QR Codes will appear throughout the manual linking to FAQ videos that may be useful.

To use the QR code, open a QR reader or the camera on your smartphone. Hold your device over the QR code so that the code is clearly visible within the device’s screen. Your phone will automatically scan the code and pull in the corresponding weblink.



Caution: Risk of Fire and Burns. Do Not Open, Crush, Heat Above 150°F or incinerate. Follow Manufacturer's Instructions



Attention, Risque d'incendie et de brulures. Veuillez ne pas ouvrir, percer, ou exposez à une chaleur égal ou supérieur à 66° C. Neas mettre dans le feu. Veuillez suivre les instructions du fabric

What is in the Box?

Included with your purchase:

(1) GC3 Battery

- Dimensions (L x W x H): 22.83" x 7.09" x 13.15"
- Weight: 80.8 lbs.
- Battery Charge Temperature Range: 25°F (-3°C) to 135°F (57.2°C)
- Battery Discharge Temperature Range: -4°F (-20°C) to 140°F (60°C)
- Water Resistant and Sealed (Batteries should not be submerged)
- Built-in BMS (Battery Management System)
- Made with Cylindrical Cells
- Mounting feet come standard, can be removed with a #3 Allen wrench
- Terminal covers come standard, can be removed with a Phillips head screwdriver
- Standard flag style terminal posts with a 3/8" hole to accommodate either a 3/8" or a 5/16" bolt

Finishing Hardware Kit

- (2) '18-8 Stainless Steel' 5/16-18 x 1" Bolts
- (2) '18-8 Stainless Steel' 5/16-18 x 1 1/4" Bolts
- (4) Washers
- (2) Nylok Nuts



GC3 Assembly Drawing



GC3 Direct Mount



GC3 Metal Bracket Mounting

What Do I Need for Installation?

If you already have your system set up and are ready to drop in your batteries, you will need a torque wrench that is able to fit to and properly torque your 5/16" finishing hardware. This is REQUIRED to make sure that you torque to the specification of 9 to 11 ft-lbs., otherwise you may cause system failures and damage.

Mounting Options

The BBGC3 has the ability to mount directly to a surface using the feet and #8 screws. See the "GC3 Direct Mount" QR code above. For more mounting options, you will need to purchase the GC3 Mounting Bracket kit at battlebornbatteries.com/shop/. See the "GC3 Metal Bracket Mounting" QR code above.

Connecting Load Specified Cables to the Batteries

1. Identify the positive and negative terminals. These are labeled and color-coded **red for positive (+)**, **black for negative (-)**.
2. Determine which finishing hardware set you will use. Verify that your bolt can fully seat into the nylok insert of the nut. If multiple lugs are used, longer bolts may be required for the bolt to fully seat into the nylok insert of the nut.
3. Connect your cable lugs to your battery terminal with the previously identified finishing hardware set. Make sure to connect your positive load specified cable lug to the positive terminal and the negative load specified cable lug to the negative terminal. The proper order to connect to your terminal with a finishing kit is shown in Fig. 1.

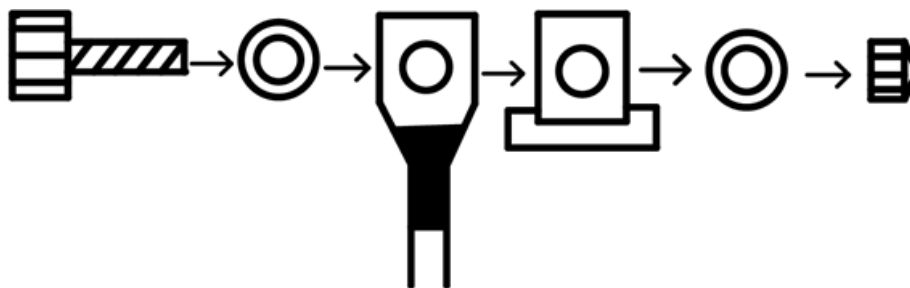
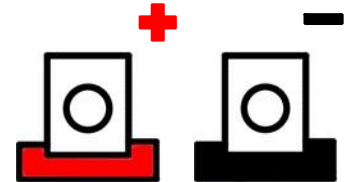

Figure 1: Proper order of hardware to connect cables. When going from left to right in the diagram the correct order is: bolt, washer, lug, terminal, washer, and nut. If multiple lugs are used, they should be on the same side of the terminal.

4. When connecting to your battery terminals, **DO NOT** finger tighten. Use a torque wrench to torque your hardware to the specification of 9 to 11 ft-lbs. Failure to adequately secure connections can result in severe damage and will void your warranty. Fig. 2 below demonstrates proper and improper connections.

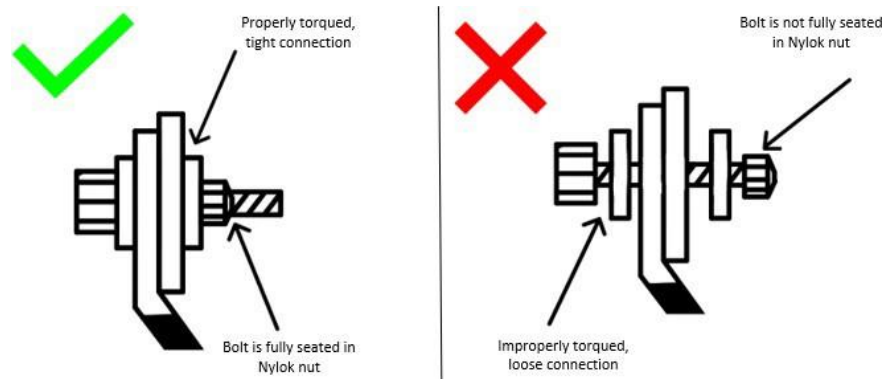

Figure 2: Proper and Improper Terminal Connections

Safety

While LiFePO4 batteries are inherently safe, as with all batteries, energy storage devices, and electrical equipment, safety and electrical hazards do exist. Failure to follow these safety instructions may result in electrical shock, injury, or death, or may damage the battery or other equipment or property.

Installation

- The battery should be installed as per national and local codes.
- The battery should only be installed in locations approved by local building codes.
- Electrical and shock hazards can be minimized by covering the solar array and using insulated tools.
- Do not short the battery terminals.
- Do not install the battery if there are any signs of physical damage.
- Do not install the battery in a location that may be flooded.

Operation

- Use only approved battery chargers for charging the battery.
- Do not disassemble the battery.
- A CSL is required for use with inverters 3500W or higher.

Emergency

- Disconnect the battery from the system.
- Wear a respirator, eye protection, and rubber gloves where appropriate.
- Use an ABC type dry chemical fire extinguisher.
- Dispose of as per local regulations.

⚠ **WARNING** ⚠

- Do not short battery terminal.
- Do not reverse polarity.
- Do not pierce battery casing.
- Do not attempt to disassemble.
- Do not drop or mishandle.
- Do not immerse in water.
- Do not operate with loose connections.
- Do not operate battery in series or in parallel with any other type of battery.
- Do not connect more than two batteries in series.
- Do not operate using cables that cannot accommodate the maximum current that can be delivered by the batteries (Please contact technical support to verify that you are using appropriate cables and contacts.)

How to Properly Charge the Batteries

To properly charge your Battle Born batteries, you will want to verify that any charging component in your system is capable of being programmed for the following specifications. Charging components can include, but are not limited to converters, inverter chargers, solar charge controllers, DC to DC chargers, etc.

- Bulk/Absorption: 14.2V – 14.6V
- Absorption Time: 60-90 minutes per battery (for parallel string)
- Float: 13.4V – 13.8V
- Equalization: 14.4V/ Disabled
- Temperature Compensation: 0/Disabled
- Charge Rate: .5c
- Battery Charge Temperature Range: 25°F (-3°C) to 135°F (57.2°C)
- Battery Discharge Temperature Range: -4°F (-20°C) to 140°F (60°C)
- Cell Charge Temperature: 32°F (0°C) to 131°F (55°C)
- Cell Discharge Temperature: -4°F (-20°C) to 140°F (60°C)

NOTE: Not all chargers are capable of multistage charging. If yours is not, you will want to verify it can be programmed for the Bulk/Absorption voltage and have the other items mentioned disabled if applicable. Consult your charger's manual or the manufacturer.

Connecting the Batteries in Parallel

Why Connect in Parallel?

Multiple BBGC3 batteries may be connected in parallel to increase the capacity and current of the system. When batteries are connected in parallel, the voltage of the system does not change, but the capacity and current limits are additive. For example, two BBGC3 batteries connected in parallel (shown in Fig. 3) create a 12V 540Ah bank that can deliver 600A continuously and 1,000A for 30 seconds.

How to Make a Parallel Connection

NOTE: All cables and connections MUST be able to accommodate the high currents that can be delivered by the battery. Appropriate fuses and circuit breakers are highly recommended to protect downstream components from current spikes and short circuits.

1. Identify the positive and negative terminals. These are labeled and color-coded **red for positive (+)**, **black for negative (-)**.
2. Determine the appropriate finishing hardware set you will use. Verify that your bolt can fully seat into the nylok insert of the nut. If multiple lugs are used, longer bolts may be required for the bolt to fully seat into the nylok insert of the nut.
3. Make the proper cable connections to the positive terminal of the first battery. Please reference Fig. 1 for the proper order of hardware.
4. When connecting to your battery terminals, **DO NOT** finger tighten. Use a torque wrench to torque your hardware to the specification of 9 to 11 ft-lbs. Failure to adequately secure connections can result in severe damage and will void your warranty.
5. Connect the other end of your positive cable to the positive terminal of the other battery you are connecting to. Repeat step 4.
6. Repeat steps 3-5 for the negative connections.
7. Repeat steps 3-6 for additional batteries in the system. An example of a finished connection can be found below in Fig. 3.1 and Fig. 3.2

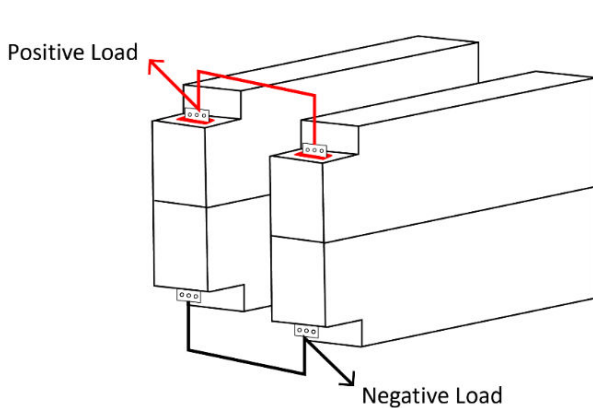

Figure 3.1: Two GC3 Batteries connected in Parallel to create a 12V 540Ah Battery Bank

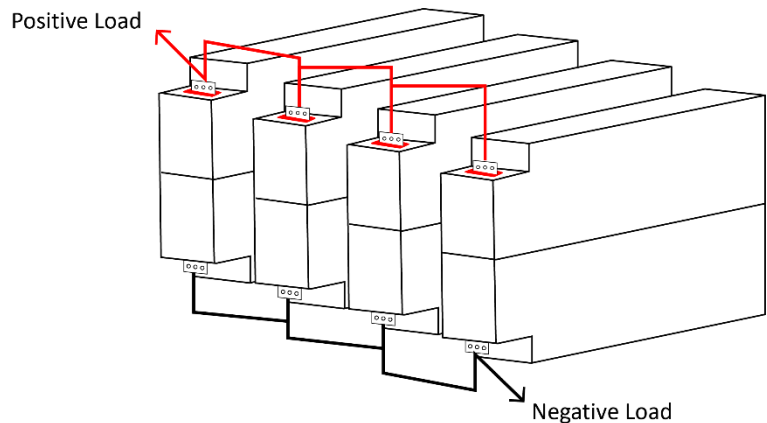

Figure 3.2: Four GC3 Batteries connected in Parallel to create a 12V 1,080Ah Battery Bank

Connecting the Batteries in Series

Why Connect in Series?

When batteries are connected in series, current capacities remain the same, but the system voltage is additive. For example, two BBGC3 batteries connected in series form a 24V 270Ah bank (shown in Fig. 4) and should be charged using a bulk and absorption voltage of 28.8V, and a float voltage of 27.2V.

How to Make a Series Connection

*Note: Battle Born GC3 batteries are capable of being connected in series up to 48V. **DO NOT** exceed a 48V setup or you will void the battery's warranty.*

1. Before making any connections, make sure to charge each battery up to 14.6V with a proper lithium charger. ALL BATTERIES SHOULD BE AT THE SAME STATE OF CHARGE PRIOR TO CONNECTING, otherwise you will encounter balance issues within your system. You can check your battery's state of charge with a multimeter.
2. Identify the positive and negative terminals. These are labeled and color-coded **red for positive (+)**, **black for negative (-)**.
3. Determine the appropriate finishing hardware set you will use. Verify that your bolt can fully seat into the nylok insert of the nut. If multiple lugs are used, longer bolts may be required for the bolt to fully seat into the nylok insert of the nut.
4. Make the proper cable connections to the negative terminal of the first battery. Please reference Fig. 1 for the proper order of hardware.
5. When connecting to your battery terminals, **DO NOT** finger tighten. Use a torque wrench to torque your hardware to the specification of 9 to 11 ft-lbs. Failure to adequately secure connections can result in severe damage and will void your warranty.
6. Connect the other end of your cable to the positive terminal of the other battery you are connecting to. Repeat step 4.
7. Repeat steps 3-6 for additional batteries, but **DO NOT** exceed 48V. An example of a correct series connection can be found below in Fig. 4.1 and Fig. 4.2.

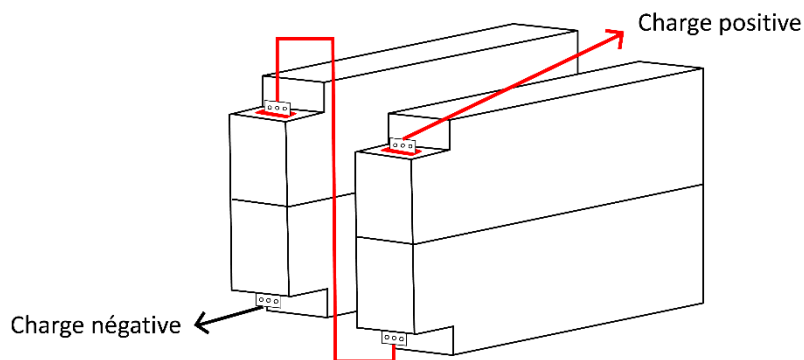

Figure 4.1: Two GC3 Batteries Connected in Series to create a 24V 270Ah Battery Bank

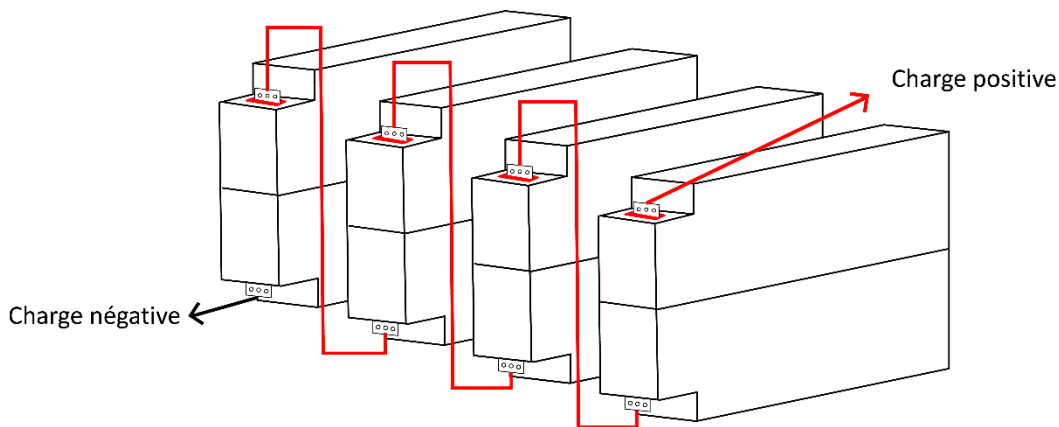

Figure 4.2: Four GC3 Batteries Connected in Series to create a 48V 270Ah Battery Ban

How Does the BMS Protect the Batteries?

All Battle Born Batteries come with a built-in battery management system (BMS) that protects the cells from many strenuous circumstances to protect the life cycles of the cells and your electrical system from potential damage. The BMS in the BBGC3 allows for 300 Amps continuous, 500 Amp surge for 30 seconds, and 1/2 second surge for loads over 500 Amps. All of our BMS' protect against the following conditions:

High Voltage Disconnect (> 14.7V)

If an individual cell voltage exceeds a prescribed threshold during charging, the BMS will prevent a charge current from continuing. Discharge is always allowed under this condition. If the batteries have not been balanced for a long time, high voltage disconnect could occur at a lower voltage. The batteries will rebalance after several full charges.

Low-Voltage Disconnect (< 10.6V)

If an individual cell falls below a prescribed threshold during discharge, the BMS will prevent further discharge. Although the battery is in "low-voltage disconnect" mode, it will still allow a charging current.

NOTE: Many chargers must detect a voltage over 10V to send a charge to the battery. Please be aware that some chargers may not sense a battery in low-voltage disconnect and you may need to jump it with a 12V source to "wake up" the battery. You should jump your battery within 24hrs of entering low-voltage disconnect otherwise you risk damaging your battery and voiding the warranty.

High Temperature Charging and Discharging (> 135°F/57.2°C)

The BMS will not allow a charging or discharging current if the internal temperature of the battery has reached 135°F (57.2°C).

Low Temperature Charging (< 25°F/-3.9°C)

The BMS will not allow a charging current under 25°F (-3.9°C) but will continue to discharge down to -4°F (-20°C).

NOTE: The BBGC3 has an operating temperature range of -4°F (-20°C) to 135°F (57.2°C).

High Current Discharge Surges

The BMS will not allow a current that exceeds 500 (+/- 5%) Amps for more than 30s, or anything larger for 0.5s. After a high current disconnection, the battery will automatically reconnect after 5 seconds.

Short Current Discharge Surges

Our BMS has built-in short circuit protection. If the short circuit protection is tripped, the BMS will shut the battery down and will remain disconnected until you remove the battery cables. While the battery cables are disconnected, we suggest taking the voltage of the battery with a voltmeter. If it reads above 10V, reconnect the battery cables. If you are unsuccessful at obtaining a voltage reading above 10V, please give our technical support team a call.

Balancing of Cells

A passive balancing process is activated by the BMS at the top of each charge cycle when the battery voltage exceeds around 14.2V. This ensures that all the cells remain at the same state of charge, which helps pack longevity and performance.

Voltage vs. Capacity

For a Single Battery

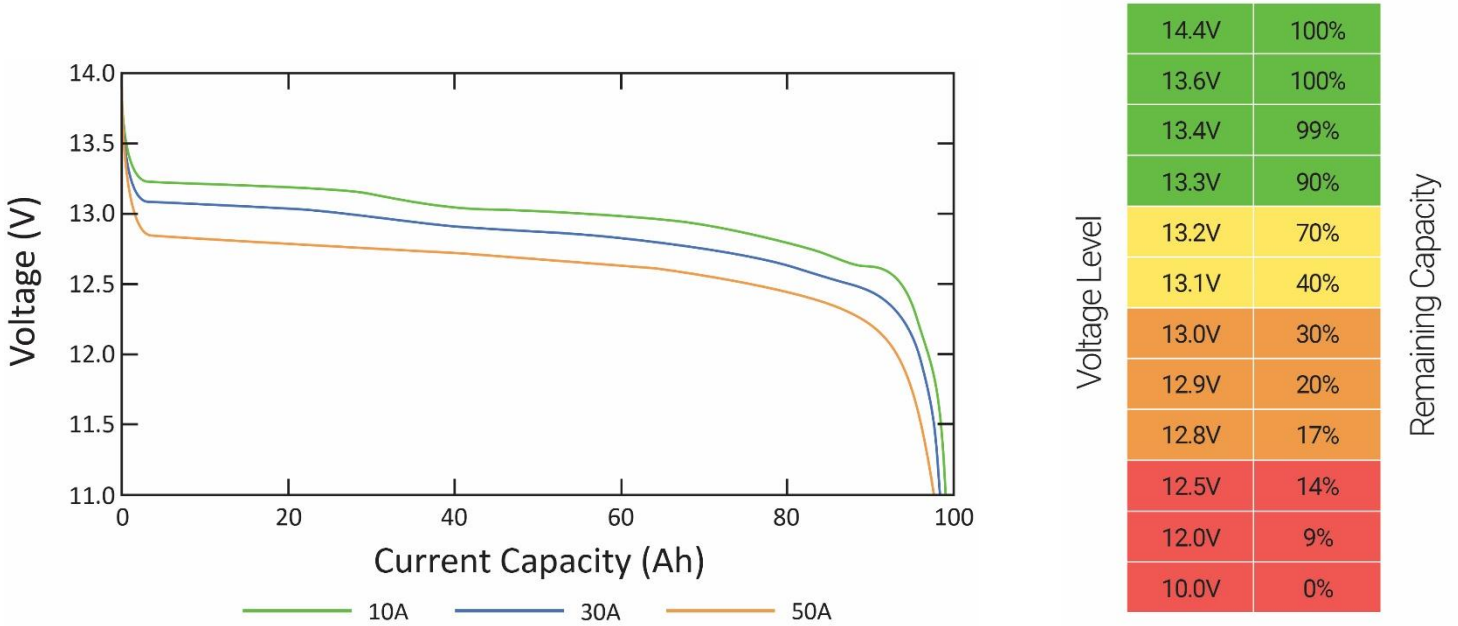

How to Properly Size Cables for System Install

When considering cable sizing there are a few factors to consider. First, what is the size of the load you are powering with the battery bank? Second, how far away from the battery is the load? You can do voltage drop calculations to see if you need to step up your cable size. Fig. 5 is a chart to use for reference. Do keep in mind that cables are only capable of carrying a certain amperage and you should verify the specifications of your cable and the power draws before implementing them into your system to avoid potential failures and damage.



Cable QR Code

CURRENT (A)	0-5	16 AWG	16 AWG	16 AWG	16 AWG	14 AWG	12 AWG	12 AWG
	5-10	16 AWG	16 AWG	14 AWG	12 AWG	10 AWG	10 AWG	10 AWG
	10-15	14 AWG	14 AWG	12 AWG	10 AWG	10 AWG	8 AWG	8 AWG
	15-20	14 AWG	12 AWG	12 AWG	10 AWG	8 AWG	6 AWG	6 AWG
	20-25	12 AWG	10 AWG	10 AWG	8 AWG	6 AWG	6 AWG	6 AWG
	25-30	10 AWG	10 AWG	10 AWG	8 AWG	6 AWG	6 AWG	4 AWG
	30-40	8 AWG	8 AWG	8 AWG	6 AWG	6 AWG	4 AWG	4 AWG
	40-50	8 AWG	8 AWG	6 AWG	6 AWG	4 AWG	4 AWG	2 AWG
	50-60	6 AWG	6 AWG	6 AWG	4 AWG	4 AWG	2 AWG	2 AWG
	60-70	6 AWG	6 AWG	4 AWG	4 AWG	2 AWG	2 AWG	1/0 AWG
	70-80	4 AWG	4 AWG	4 AWG	4 AWG	2 AWG	2 AWG	1/0 AWG
	80-90	4 AWG	4 AWG	4 AWG	2 AWG	2 AWG	1/0 AWG	1/0 AWG
	90-100	2 AWG	2 AWG	2 AWG	2 AWG	2 AWG	1/0 AWG	1/0 AWG
	100-120	2 AWG	2 AWG	2 AWG	2 AWG	1/0 AWG	1/0 AWG	2/0 AWG
	120-150	1/0 AWG	1/0 AWG	1/0 AWG	1/0 AWG	1/0 AWG	2/0 AWG	4/0 AWG
150-200	2/0 AWG	2/0 AWG	2/0 AWG	2/0 AWG	2/0 AWG	4/0 AWG	4/0 AWG	
		0-4	4-7	7-10	10-15	15-20	20-25	25-30
LENGTH IN FEET								

Figure 5: As a rule of thumb, you can use these numbers as a guideline.

How to Incorporate Fuses into System Install

ANL fuses are designed to melt and separate into two pieces for the purpose of breaking a circuit in the event of excessive current. These fuses are essential components for protecting against a catastrophic event and are typically placed between Battle Born Batteries and the inverter/load.



Fuse QR Code

How to Properly Store Batteries

We recommend bringing the Battle Born batteries to a 100% state of charge. Then, disconnect the battery from any loads by removing the negative cable from one battery. On average, the batteries lose approximately 2-3% capacity per month. This is subject to increasing if stored in extreme environmental conditions.



Storage QR Code

How to Maintain the Batteries

Battle Born Batteries require very little maintenance. If your batteries are in series and not being charged by a multi-bank charger it is recommended that you fully charge the batteries individually once a month if the system is used frequently. This will internally balance your batteries to ensure that they will reach their expected life span and allow you to get the full power out of them with each use. If your batteries are in parallel this is not necessary, just make sure the batteries are charged to 14.2V – 14.6V frequently for internal balance. Our BMS has a built-in passive balancing system that will take care of this for you.



FAQ QR Code

Please Note: A CSL is required for use with inverters 3500W or higher.

For more FAQs scan the QR code.

To see what else Battle Born Batteries has to offer, scan the QR code to the right or visit

<https://battlebornbatteries.com/shop/>



Battery Line QR Code

How to Properly Recycle and Dispose of the Batteries

Here at Dragonfly Energy our goal is to provide our customers with long lasting green energy that will support them for years on all their adventures. That is why we not only build batteries that can keep up with you for a long time but also provide industry leading customer support to help you get the most out of your batteries. When the time does come, and your batteries have reached the end of their lifetime it is important to recycle them responsibly.

Here are a few suggestions:

1. Make sure all loads are removed from your system before removing the batteries. Once the batteries are removed cover the terminals using electrical tape. Now can be a good time to inspect any cable runs or lugs.
2. Visit www.earth911.com or www.call2recycle.org/locator to find a drop off location. Be sure to call ahead of time to confirm that the drop off location is still accepting materials.
3. Give us a call if you are having any trouble finding a drop off location and we can help you find one.

Limited Warranty

Please find Limited Warranty information online at <https://battlebornbatteries.com/limited-warranty/> or via phone at (855) 292-2831.



Limited Warranty QR Code

Return Policy

You have 30 calendar days to return an item from the invoice date. To be eligible for a return, your item must be in the same condition that you received it in. You must have the receipt or proof of purchase. If an item is new, unused, and in the original packaging, we are happy to accept a return up to 30 days from the original invoice date with no restocking fee. The item must be returned with its original packaging. Original packaging must be in the same condition as it was received, otherwise you may be responsible for a restocking fee. If the item has been installed, used, or no longer has the original packaging, we will assess a restocking fee that will be shared when the return merchandise authorization (RMA) is issued. Items 60 days past the original invoice will be reviewed at Battle Born's discretion.

Returns will not be accepted without an RMA number, which can be obtained by filling out the return form at <https://battlebornbatteries.com/returns/>. To avoid being charged restocking fees, review the full return/refund policy at <https://battlebornbatteries.com/terms-conditions/#returns>.

Refund Policy

You have 30 calendar days to return an item from the invoice date. Once we receive your item, we will inspect it and notify you that we have received your returned item. We will immediately notify you of the status of your refund after inspecting the item. If your return is approved, we will initiate a refund to your credit card (or original method of payment). You will receive the credit within a certain amount of days, depending on your card issuer's policies. No refund is guaranteed after the initial 30 days has passed or if the item has been used.

Shipping

You will be responsible for paying for your own shipping costs for returning your item. If you are returning prior to 30 days from the original ship date, you may be eligible for a free return. In order to be eligible for free shipping, you **MUST** have the original packing in which the order was shipped, including boxes, foam, wrapping, and pallets if necessary. Not all items will be eligible for free return shipping. Shipping costs are nonrefundable. If you receive a refund, the cost of return shipping may be deducted from your refund.

If you have any questions, please contact us by calling 855-292-2831 or email us at info@battlebornbatteries.com.

Notice: Product improvements and enhancements are continuous; therefore, the specifications and information contained in this document may change without notice. Dragonfly Energy Corp. shall not be liable for errors contained herein or for incidental or consequential damages in connection with the furnishing, performance, or use of this material. No part of this document may be photocopied, reproduced, or translated to another language without the prior written consent of Dragonfly Energy Corp.

Copyright © 2022, Dragonfly Energy Corp., all rights reserved. Battle Born Batteries® is a registered trademark of Dragonfly Energy Corp. All other trademarks, trade names, service marks, and logos referenced herein belong to their respective owners.

Lithium-ion vs. Lead-Acid

	Battle Born Batteries 100Ah 12V	Lead-Acid 200Ah 12V
Depth of Discharge	100%	50%
Self-Discharge Rate	2-3% Per Month	Average of 33% Per Month
Battery Life	3,000-5,000 Cycles	500-1,200 Cycles
Weight	31 lbs	144 lbs
Warranty	10 Years	2-3 Years
Customer Support	Lifelong	Non-Existent
Upfront Cost	Under \$1,000	\$450
Cost Over 10 Years	Under \$1,000 at Initial Purchase	\$1,350-\$3,600
Battery Protection	Internal Battery Management System (BMS)	Non-Existent

Recommended Accessories (Available via battlebornbatteries.com or call us at 855.292.2831)

BMV-712

With Bluetooth built-in, the BMV-712 is the most efficient way to monitor your system. Being a shunt-based device, the unit will monitor power coming in and out of your system all at the palm of your hand. This device is highly recommended to give you the most accurate reading on your batteries.



MultiPlus Compact 2000 W

The Victron MultiPlus Compact Inverter Charger, as the name suggests, is a combined inverter and charger in one elegant package. Its many features include a true sine wave inverter, adaptive charging, and hybrid Power Assist technology, plus multiple system integration features.

*This unit pairs well with 200Ah or more of battery capacity.



MultiPlus 3000 W

The Victron MultiPlus Inverter Charger, as the name suggests, is a combined inverter and charger in one elegant package. Its many features include a true sine wave inverter, adaptive charging, and hybrid Power Assist technology, plus multiple system integration features.

* This unit pairs well with 300Ah or more of battery capacity.



MultiPlus-II

With all the functionality of a MultiPlus and a MultiGrid, the MultiPlus-II 2x 120V is a great option for those with 50A 120/240VAC split-phase applications. Whether it is supplied from shore power or a generator, the MultiPlus-II 2x 120V can accept and pass through both lines of a 120/240V supply, with the capability to utilize the full 50A for charging and AC loads.

* This unit pairs well with 300Ah or more of battery capacity.



Solar Charge Controller 100/50

A solar charger gathers energy from your solar panels and stores it in your batteries. Using the latest, fastest technology, SmartSolar maximizes this energy harvest, driving it intelligently to achieve full charge in the shortest possible time. SmartSolar maintains battery health, extending its life.

* This device pairs well with up to 700 W of solar with a 12V battery bank.



Cerbo GX

The Cerbo GX communication center maximizes your system's performance and allows you to always have complete control over your system from wherever you are. Simply connect through the Victron Remote Management (VRM) Portal, access directly using the separate [GX Touch](#) 50, or use the VictronConnect App with the device's added Bluetooth capability.

* RJ45 and VE Direct wires will be required to allow other Victron items to communicate info to the Cerbo.



Orion DC-DC Charger

The Victron Orion-Tr Smart DC-DC Charger is a DC to DC adaptive 3-stage charger with built-in Bluetooth. This device can be used in dual battery systems in vehicles or on boats where the alternator and the start battery are used to charge your house batteries. The unit can be monitored and programmed via Bluetooth and can be remotely controlled via a remote on/off switch.

* The Orion-Tr Smart DC-DC Charger can be used in 12V or 24V systems. Models are available up to 400W and multiple units can be connected in parallel to increase output power.



IP65

The Blue Smart IP65 Charger is a professional battery charger with built-in Bluetooth. The Blue Smart IP65 Charger is a 12-volt, 15-amp charger that can be used with lithium-ion batteries in RVs, boats, and campervans.

* This device is a great addition to offer a handheld charger to top off your batteries before connecting into your system.



Rich Solar Panels

Coming in a variety of options, Rich Solar Panels offer Mono PERC Technology, a lightweight, anodized aluminum frame, high transmission, anti-reflective coated tempered glass, a plug-and-play junction box, and industry-standard quick-connect cables that work in series or in parallel. These panels are certified to withstand challenging environmental conditions and are excellent with low light performance on cloudy days, mornings, and evenings.

