



Model BB10012H

100AH 12V
LiFePO₄ Deep Cycle Battery

Data sheet

Electrical Specification

Voltage	12V
Capacity	100AH
Operating Temperature	- 4°F (-20°C) to 135°F (57.2°C)
Efficiency	99%
Self Discharge	2-3% per month
Maximum Series Voltage	48V
Cycles	3K-5K
Built-in BMS	Internal
Resistance	12 mΩ
Usable DoD	100%

Discharging Specification

Max Discharge Current	100A
Peak Discharge Current	200A for 30 Seconds
Surge for Loads over 500A	.5 Seconds
Recommended LVD	10.5V
BMS Discharge Voltage Cut-Off	10V
Reconnect Voltage	10V
Short Circuit Protection	Yes

Recognized Specification

Certifications	UN38.3, UL/CSA-62133-2, UL-2054
Shipping Class	UN3480, Class 9

Drawing Specification

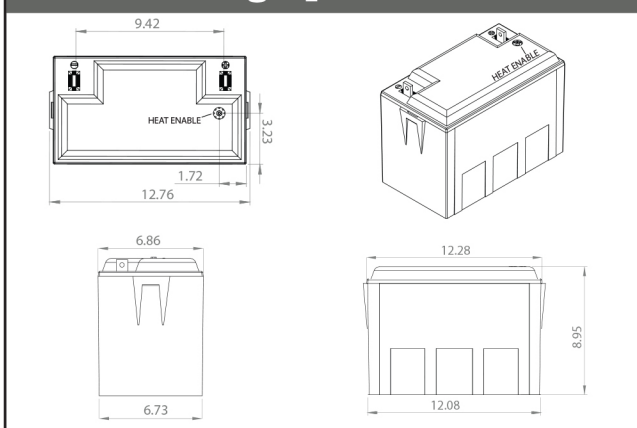

Charging Specification

Recommended Charge Current	.5c
Max Charge Current	50A
Absorption Voltage	14.2V-14.6V
Float Voltage	13.4V-13.8V
Equalization Voltage (if applicable)	14.4V
Absorption Time	30 Minutes per 100AH battery bank
BMS Charge Current Cut-Off	.5C Recommended
Recharge/Rebulk Voltage	13.3V
BMS Cell Balancing Voltage Range	14.2V-14.6V
High BMS Voltage Protection	14.7VDC
Temperature Compensation	No/Disable

Mechanical Specification

Dimensions	12.76" L X 6.86" W X 8.95" H
Weight	31 lbs.
Terminal Type	.25" Brass
Terminal Hole	3/8" hole and 3/8" or 5/16" hardware is suggested
Terminal Torque	9-11 Ft-lb.
Case Material	ABS Fire Rated
Cell Type - Electrolyte	LiFePO ₄
Sealed and Water Resistant Case	Non-Submersible
Heat	Proprietary Internal Heating Solution
Heat Enable Terminal	Female M4 Thread

Temperature Specification

Discharge Temperature	-4°F to 135°F (-20°C to 57.2°C)
Charge Temperature	25°F - 135°F
Storage Temperature	-10°F to 140°F (-23°C to 60°C)
BMS High Temperature Cut-Off	>135°F
BMS Reconnect Temperature	<135°F



Model BB10012H

100AH 12V
LiFePO₄ Deep Cycle Battery
Data sheet

Performed Operation Data

.5C Discharge with Temperature Variations

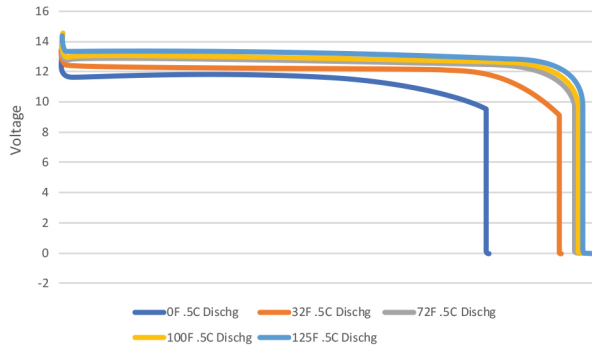

1C Discharge Voltage with Temperature Variations

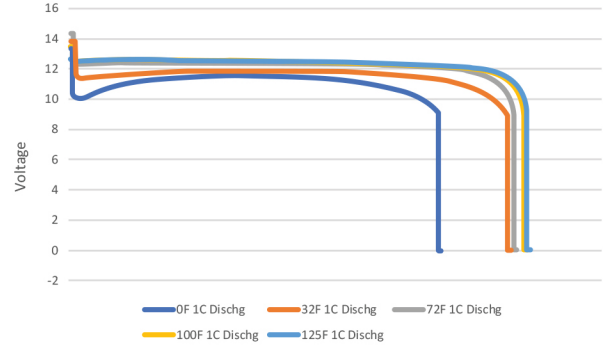

.5C State of Charge with Temperature Variations

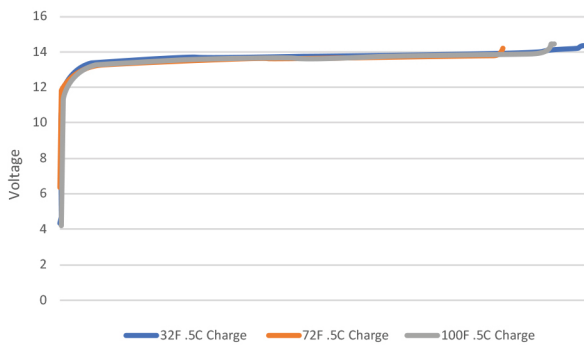

Standard Charge Curve with 3 Stage Charger

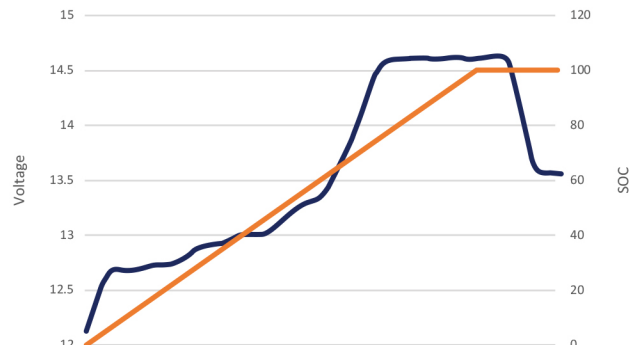

10012 Heater Draw Expected in a 24Hr Period

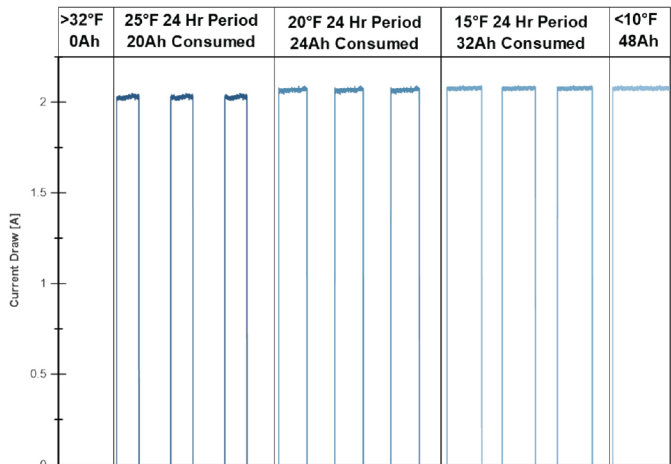
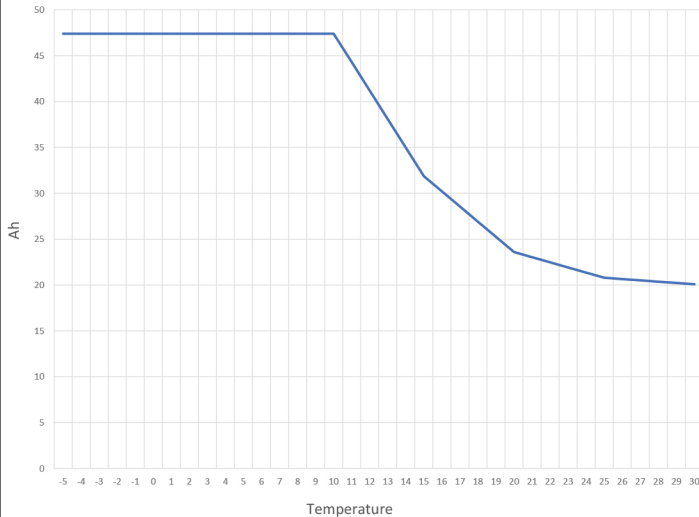

	ON	OFF	Total Cycle Time	Ah One Cycle	Ah Expected (24 Hr Period)
15F	5.01	2.92	7.93	10.53	31.87
20F	4.17	4.70	8.87	8.76	23.72
25F	3.19	4.56	7.75	6.71	20.79

*Note: The storage temperature range is -10°F to 140°F (-23°C to 60°C). We recommend bringing the Dragonfly Energy Batteries to a 100% charge and then disconnecting them completely for storage. After six months in storage, your batteries will remain 75 - 80% charged.

Storing batteries in subzero weather (-15°F or more) has the potential to crack the ABS plastic and more importantly could cause a faster loss of capacity, in some cases drastically more than the typical 2 - 4% per month loss.