

Smart choice for power

xantrex



C35
C40
C60

Owner's Manual

C-Series Multifunction DC Controller

C-Series Multifunction DC Controller

Owner's Guide

About Xantrex

Xantrex Technology Inc. is a world-leading supplier of advanced power electronics and controls with products from 50 watt mobile units to one MW utility-scale systems for wind, solar, batteries, fuel cells, microturbines, and backup power applications in both grid-connected and stand-alone systems. Xantrex products include inverters, battery chargers, programmable power supplies, and variable speed drives that convert, supply, control, clean, and distribute electrical power.

Trademarks

C-Series Multifunction DC Controller is a trademark of Xantrex International. Xantrex is a registered trademark of Xantrex International.

Other trademarks, registered trademarks, and product names are the property of their respective owners and are used herein for identification purposes only.

Notice of Copyright

C-Series Multifunction DC Controller Owner's Guide © November 2003 Xantrex International. All rights reserved.

Disclaimer

UNLESS SPECIFICALLY AGREED TO IN WRITING, XANTREX TECHNOLOGY INC. ("XANTREX")

- (a) MAKES NO WARRANTY AS TO THE ACCURACY, SUFFICIENCY OR SUITABILITY OF ANY TECHNICAL OR OTHER INFORMATION PROVIDED IN ITS MANUALS OR OTHER DOCUMENTATION.
- (b) ASSUMES NO RESPONSIBILITY OR LIABILITY FOR LOSS OR DAMAGE, WHETHER DIRECT, INDIRECT, CONSEQUENTIAL OR INCIDENTAL, WHICH MIGHT ARISE OUT OF THE USE OF SUCH INFORMATION. THE USE OF ANY SUCH INFORMATION WILL BE ENTIRELY AT THE USER'S RISK.

About This Guide

Purpose

The purpose of this Guide is to provide explanations and procedures for installing, operating, maintaining, and troubleshooting the C-Series Multifunction DC Controller.

Scope

This Guide provides safety guidelines, detailed planning and setup information, procedures for installing the inverter, as well as information about operating and troubleshooting the unit. It does not provide details about particular brands of batteries. You need to consult individual battery manufacturers for this information.

Audience

This Guide is intended for anyone who needs to install and operate the C-Series Multifunction DC Controller. Installers should be certified technicians or electricians.

Organization

This Guide is organized into four chapters and three appendices.

Chapter 1 describes features and functions of the C-Series Multifunction DC Controller.

Chapter 2 contains information and procedures to install C-Series Multifunction DC Controller.

Chapter 3 contains information about the operation of a C-Series Multifunction DC Controller.

Chapter 4, “Troubleshooting” contains information about identifying and resolving possible problems with systems using a C-Series Multifunction DC Controller.

Appendix A, “Specifications” provide the specifications for the C-Series Multifunction DC Controller.

Appendix B, “Batteries” describes types of batteries.

Appendix C, “Diversion Loads” provides additional information about Diversion Loads.

Conventions Used

The following conventions are used in this guide.



WARNING

Warnings identify conditions that could result in personal injury or loss of life.



CAUTION

Cautions identify conditions or practices that could result in damage to the unit or to other equipment.

Important: These notes describe an important action item or an item that you must pay attention to.

Abbreviations and Acronyms

ASC	Authorized Service Center
BTS	Battery Temperature Sensor
CM	C-Series Meter
CM/R	C-Series Meter - Remote
DC	Direct Current
LCD	Liquid Crystal Display
LED	Light Emitting Diode
LVD	Low Voltage Disconnect
LVR	Low Voltage Reconnect
RE	Renewable Energy

Related Information

You can find more information about Xantrex Technology Inc. as well as its products and services at www.xantrex.com.

Important Safety Instructions



WARNING

This manual contains important safety instructions that should be followed during the installation and maintenance of this product. *Be sure to read, understand, and save these safety instructions.*

General Safety Instructions

- All electrical work must be done in accordance with local, national, and/or international electrical codes.
- Before installing or using this device, read all instructions and cautionary markings located in (or on) this guide, the controller, the batteries, PV array, and any other equipment used.
- This product is designed for indoor mounting only. Do not expose this unit to rain, snow or liquids of any type. In outdoor installations, the C-Series controller must be installed in a rainproof enclosure to eliminate exposure to rain or water-spray.
- To reduce the chance of short-circuits, use insulated tools when installing or working with the inverter, the controller, the batteries, or any DC source (e.g., PV, hydro, or wind).
- Remove all jewelry. This will greatly reduce the chance of accidental exposure to live circuits.
- The controller contains more than one live circuit (batteries and PV array, wind, or hydro). Power may be present at more than one source.
- This product contains no user serviceable parts. Do not attempt to repair this unit unless fully qualified.

Battery Safety Information

- Always wear eye protection, such as safety glasses, when working with batteries.
- Remove all jewelry before working with batteries.
- Never work alone. Have someone assist you with the installation or be close enough to come to your aid when working with batteries.
- Always use proper lifting techniques when handling batteries.
- Always use identical types of batteries.
- Never install old or untested batteries. Check each battery's date code or label to ensure age and type.
- Batteries should be installed in a well-vented area to prevent the possible buildup of explosive gasses. If the batteries are installed inside an enclosure, vent its highest point to the outdoors.
- When installing batteries, allow at least 1 inch of air space between batteries to promote cooling and ventilation.
- NEVER smoke in the vicinity of a battery or generator.
- Always connect the batteries first, then connect the cables to the inverter or controller. This will greatly reduce the chance of spark in the vicinity of the batteries.
- Use insulated tools when working with batteries.
- When connecting batteries, always verify proper voltage and polarity.
- Do not short-circuit battery cables. Fire or explosion can occur.
- In the event of exposure to battery electrolyte, wash the area with soap and water. If acid enters the eyes, flood them with running cold water for at least 15 minutes and get immediate medical attention.
- Always recycle old batteries. Contact your local recycling center for proper disposal information.



CAUTION:

A battery can produce the following hazards to personal safety:

- electrical shock,
- burn from high-short-circuit current, and/or
- fire or explosion from vented gasses.

Observe proper precautions when working with or around batteries.

Contents

Important Safety Instructions -----vii

1 Introduction

Features ----- 2

Operating Modes ----- 3

 Charge Control Mode ----- 4

 Three-Stage Battery Charging ----- 4

 Battery Temperature Compensation ----- 6

 Manual or Auto Equalization Charge ----- 6

 Load Control Mode----- 6

Controller Functions ----- 7

 Photovoltaic Charge Controller----- 7

 Automatic PV Array Night Disconnect----- 8

 Diversion Controller ----- 8

 Diversion Loads ----- 9

 Load Controller ----- 10

 Low Voltage Disconnect ----- 11

 Low Voltage Reconnect----- 11

Optional Accessories ----- 12

2 Installation

Pre-Installation ----- 14

 Removing the Top Cover----- 14

 Removing Knockouts ----- 14

 Mounting the Controller ----- 16

Configuring the C-Series Controller ----- 18

 Jumper Settings ----- 18

 Operating Mode Jumper----- 20

 Voltage Jumper----- 20

- Automatic/Manual Battery Equalization (EQ) and Low Voltage Reconnect (LVR) Jumper ----- 21
- Adjusting the C-Series Voltage Settings----- 22
 - Setting Voltage Parameters for Charge Control Mode----- 22
 - Setting Voltage Parameters for Load Control Mode ----- 24
 - Setting Voltage Parameters Diversion Control Mode ----- 26
 - Setting Voltage Parameters for Alkaline Batteries ----- 26
 - Using a Digital Voltmeter to Adjust Voltage Settings----- 28
- Equalization Charging----- 30
 - Manual Equalization ----- 31
 - Automatic Equalization ----- 32
 - Terminating the Equalization Process ----- 33
- Temperature Compensation ----- 33
 - Temperature Compensation Based on Battery Type ----- 34
 - Automatic Battery Temperature Compensation ----- 34
 - Manual Battery Temperature Compensation ----- 36
- Grounding----- 37
- Wiring ----- 38
 - DC Terminal Connector Locations ----- 38
 - Terminal Torque Requirements ----- 39
 - Wire Size and Over-current Protection Requirements----- 39
 - Current Rating ----- 39
 - Minimum Recommended Wire Gauge ----- 40
 - Surge Protection ----- 40
 - Over-current Protection ----- 41
 - Long-distance wire runs ----- 42
 - Maximum One-way Distance and Wire Size ----- 42
 - PV Charge Control Mode Wiring ----- 44
 - Diversion Control Mode Wiring ----- 46
 - DC Load Control Mode Wiring----- 48
- Installing Optional Accessories----- 50
 - Installing a Digital Display----- 50
 - Installing the Battery Temperature Sensor ----- 51
- Reinstalling the Faceplate ----- 52

3 Operation

Basic Operation	54
LED Status Indicator	55
Charge Control or Diversion Control Indications (Green)	56
Blinking Green	57
Solid Green	57
Equalization Mode Indication (Red/green)	58
Load Control Indications (Red)	58
Blinking Red	58
Solid Red	58
Error Mode Indication (Orange)	59
Over-temperature Condition	59
Over-Current Condition	59
Low-voltage Disconnect Condition	60
Reconnecting to Loads	60
Reset Switch	61

4 Troubleshooting

PV Charge Control Troubleshooting	64
Diversion Control Troubleshooting	66
Load Control Troubleshooting	68

A Specifications

Electrical Specifications	70
Features and Options Specifications	71
Environmental Specifications	72

B Batteries

Battery Types	74
Automotive Batteries	74
Maintenance-Free Batteries	74
Deep-Cycle Batteries	74
Sealed Batteries	75
NiCad and NiFe Batteries	76

Contents

Battery Sizing ----- 76
Equalization Charging----- 77
 Equalization Setpoints (Non-Sealed Batteries Only)----- 79

C Diversion Loads

Diversion Load Types----- 82

Warranty and Product Information

Warranty ----- 85
Disclaimer ----- 86
Return Material Authorization Policy ----- 87
Return Procedure ----- 88
Out of Warranty Service ----- 88
Information About Your System ----- 89

Index----- 91

Figures

Figure 1-1	C-Series Multifunction DC Charge Controllers - - - - -	2
Figure 1-2	3-stage Battery Charging Process - - - - -	5
Figure 1-3	PV Charge Controller - - - - -	7
Figure 1-4	Diversion Controller - - - - -	9
Figure 1-5	Load Controller - - - - -	11
Figure 1-6	Decal Displaying Load Control Voltage Settings - - - -	12
Figure 1-7	Optional Accessories - CM/R, CM, and BTS- - - - -	12
Figure 2-1	Removing the Front Cover - - - - -	14
Figure 2-2	C-Series Dimensions and Knockout Locations (Not to Scale)- - - - -	15
Figure 2-3	Mounting the C-Series Multifunction DC Controller -	17
Figure 2-4	Jumper Positions- - - - -	18
Figure 2-5	Circuit Board Components - - - - -	19
Figure 2-6	Mode of Operation Jumper- - - - -	20
Figure 2-7	Voltage Selection Jumper- - - - -	20
Figure 2-8	EQ/LVR Jumper and Reset Switch - - - - -	21
Figure 2-9	Bulk and Float Charge Potentiometers (pots)- - - - -	22
Figure 2-10	Bulk and Float Charge Settings for Charge/Diversion Control Mode- - - - -	23
Figure 2-11	Potentiometers with Decal for LVR and LVD Settings	24
Figure 2-12	LVR and LVD Settings for Load Control Mode- - - - -	25
Figure 2-13	R46 Resistor Location - - - - -	26
Figure 2-14	Voltage Settings with R46 Resistor Clipped - - - - -	27
Figure 2-15	Test Points for Adjusting Voltage Using a DVM - - - -	29
Figure 2-16	Manual Equalization Settings - - - - -	30
Figure 2-17	Front Panel LED and Reset Switch Location- - - - -	31
Figure 2-18	Auto Equalization Settings - - - - -	32
Figure 2-19	Terminating the Equalization Charge - - - - -	33
Figure 2-20	Grounding the C-Series Chassis - - - - -	37
Figure 2-21	DC Connection Terminals - - - - -	39

Figures

Figure 2-22	AWG Wire Gauge Reference Chart -----	40
Figure 2-23	PV Charge Control Mode Wiring -----	45
Figure 2-24	Diversion Control Mode Wiring -----	47
Figure 2-25	Load Control Mode Wiring -----	49
Figure 2-26	Installing a Digital Display -----	50
Figure 2-27	Installing the BTS -----	51
Figure 2-28	Re-installing the CM Faceplate -----	52
Figure 3-1	C-Series Status LED and Reset Button Location ----	54
Figure 3-2	C-Series Front Panel Label -----	55
Figure 3-3	Reset Switch -----	61

Tables

Table 2-1	Factory Default Settings for C-Series Controllers- - - -	19
Table 2-2	Variances in Charging Voltage based on Battery Temperature - - - - -	35
Table 2-3	Minimum Wire Size - - - - -	41
Table 2-4	One-Way Wire Distance and Wire Size - - - - -	43
Table 3-1	Battery Voltage LED Indicators - - - - -	56
Table 4-1	PV Charge Control Problems - - - - -	64
Table 4-2	Diversion Control Problems - - - - -	66
Table 4-3	Load Control Problems - - - - -	68
Table A-1	Electrical Specifications- - - - -	70
Table A-2	Features and Options Specifications- - - - -	71
Table A-3	Environmental Specifications - - - - -	72
Table B-1	Typical Bulk and Float Setpoints for Batteries- - - - -	79
Table C-1	Power Dissipation- - - - -	82

1

Introduction

Chapter 1 describes features and functions of the C-Series Multifunction DC Controller.

For information on:	See:
“Features”	page 2
“Operating Modes”	page 3
“Controller Functions”	page 7
“Optional Accessories”	page 12

Features

The C35/C40/C60 (C-Series) controllers can be used with 12-volt, 24-volt, or 48-volt DC systems (depending upon model) as Charge Controller or a Load Controller.

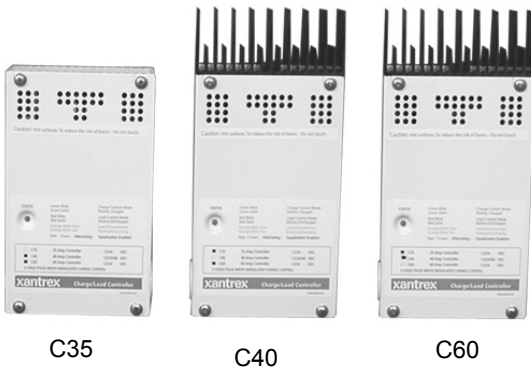

Figure 1-1 C-Series Multifunction DC Charge Controllers

Numerous features are provided standard to maximize the performance of the system:

- Solid-state Pulse Width Modulated (PWM) charging process with three-stage control, temperature compensation, and manual or automatic equalization to maximize system performance and increase battery life.
- Multi color LED with easy to read mode/status label.
- Electronic overload and short-circuit protection with automatic and manual reset capability increases the reliability of unattended systems by eliminating blown fuses and tripped circuit breakers.
- Adjustment of charge setpoints is provided by rotary controls (potentiometers) with removable knobs. Calibrated scales and test points allow precise adjustments of settings.
- Over-temperature protection for the electronic circuitry when used in hot environments (over 113 °F/45 °C).

- Indoor-type, powder-coated enclosure, for wall mounting.
- Conformal-coated circuit boards, plated terminals, powder-coated metal components, and stainless steel fasteners improves tolerance to hostile environments.
- Meets National Electrical Code (NEC) and other international controller specifications.
- The C35, C40 and C60 models are UL listed to the U.S. UL Standard 1741 (1st edition), and Canada (CSA-C22.2 No. 107.1-95).
- 2-year limited warranty.

Operating Modes

The DC controller is a critical component in any solar, wind or hydro power generation system and protects the batteries from over-discharge and over-charge conditions. The C-Series has two operating modes (Charge Control mode and Load Control mode determined by the Operating mode jumper (See Figure 2-5). These two different operating modes allow the C-Series to be installed and function as three different DC controllers.

- **Charge Control Mode**
 - *PV Charge Controller* - controls charging in PV installations.
 - *Diversion Controller* – used in PV, wind, or hydro installations to divert any excess energy to a diversion load and in the case of a wind or hydro generator, helps to prevent over-spin damage.
- **Load Control Mode**
 - *Load Controller* - prevents damage to the battery from over-discharge during periods of poor charging or excessive loads.

Important: The C-Series controller cannot operate in more than one function at the same time. *If several functions are required in a system, a dedicated controller must be used for each function.*

Charge Control Mode

In the Charge Control mode, the C-Series controls how the batteries are charged by the DC source (solar, wind, or hydro). It uses a 3-stage charging protocol to maintain battery voltage at bulk and/or float levels.

When charging, the C-Series controller monitors the batteries and depending on how it is wired will regulate the PV current (as a PV Charge Controller) or divert excess energy from PV, hydro, or wind to a DC load (as a Diversion Controller) and allows the battery to charge according to user-defined settings based on the amount of DC power available.

When the C-Series operates in the Charge Control mode, it provides:

- three-stage charging of battery voltage,
- automatic temperature compensation (if the BTS is used), and
- automatic or manual equalization charging.

Three-Stage Battery Charging

The three-stage charging process results in faster charging compared to on-off relay type or constant voltage solid-state regulators. Faster recharging increases the performance of the system by storing more of the PV array's limited output. The final float voltage setting reduces battery gassing, minimizes watering requirements and ensures complete battery recharging. The C-Series will use this protocol in either PV Charge Control mode or in Diversion Control mode. It does not charge the batteries when in Load Control mode. Battery voltage and current vary during the three-stage charging process as follows.

Bulk Stage

During this stage, the batteries are charged at the bulk voltage setting and maximum current output of the DC source. When the battery voltage reaches the bulk voltage setting, the controller activates the next stage (absorption).

Absorption Stage

During this stage, the voltage of the battery is held at the bulk voltage setting until an internal timer has accumulated one hour. Current gradually declines as the battery capacity is reached.

Float Stage

During this stage, the voltage of the battery is held at the float voltage setting. Full current can be provided to the loads connected to the battery during the float stage from the PV array. When battery voltage drops below the float setting for a cumulative period of one hour, a new bulk cycle will be triggered.

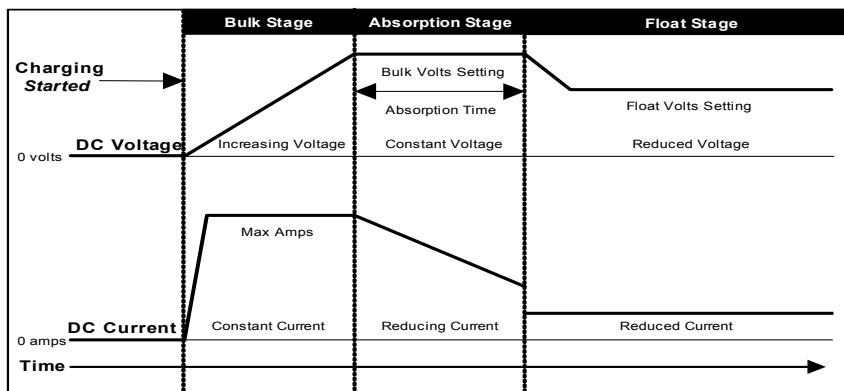

Figure 1-2 3-stage Battery Charging Process

Battery Temperature Compensation

The optional Battery Temperature Sensor (BTS) automatically adjusts the charging process of the C-Series controller. With the BTS installed, the C-Series will increase or decrease the battery charging voltage depending on the temperature of the battery to optimize the charge to the battery and maintain optimal performance of the battery.

If not using the BTS, the voltage settings for charging will need to be adjusted based on the temperature of the environment around the batteries and on the type of batteries being used.

See “Temperature Compensation” on page 33 for information on how to set the voltage.

Manual or Auto Equalization Charge

The C-Series controller can be used to manually or automatically provide the battery bank with an equalize charge. Factory default setting is for MANUAL Equalization charging. Be sure to be familiar with all the cautions and warnings concerning equalization charging batteries or damage to batteries can occur.

Load Control Mode

In the Load Control mode, the C-Series controls when to remove a load or loads from the system when an over-discharge or over-load situation occurs. The C-Series controller uses the user-adjustable setpoints to determine when to connect or reconnect loads depending on battery voltage. A load controller prevents damage to the battery from over-discharge during periods of poor weather or excessive loads. The unit does not charge the batteries when in this function.

Controller Functions

The C-Series can be configured to function as three different controllers:

- PV Charge Controller (Charge Control mode)
- Diversion Controller (Charge Control mode)
- Load Controller (Load Control mode)

Photovoltaic Charge Controller

The C-Series controller can operate as a Photovoltaic Charge Controller, also called a “series regulator”. Depending on the model, the controller can regulate up to 60 amps of continuous photovoltaic (PV) array current at 12 or 24 volts (C60 or C35 models), or 12-, 24- or 48-volts DC (C40 model) for charging batteries. This rating includes the NEC required derating.

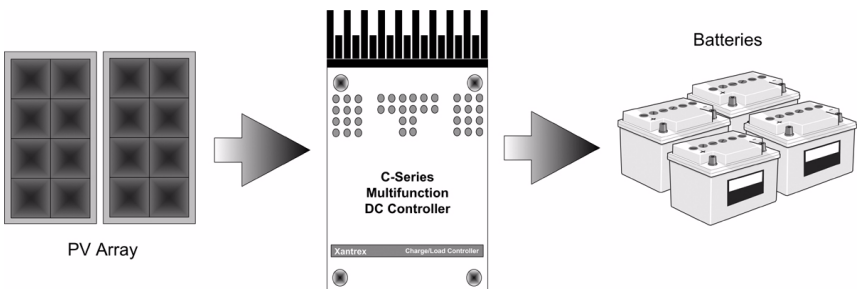

Figure 1-3 PV Charge Controller

If the PV array’s output increases above the rated amp level due to reflection or “edge of cloud effect,” the controller will continue to operate until the heatsink reaches a maximum safe operating temperature. This will take several minutes to occur, depending upon the ambient temperature involved. When the heatsink reaches the maximum safe temperature, the controller will reduce the current, cooling the transistors and the heatsink.

If the current from the PV array reaches 85 amps, the controller will turn off to protect the circuitry. In the event of a shutdown, the controller automatically resets itself after 10 minutes (if overcurrent condition is no longer present).

See “Operating Mode Jumper” on page 20 for information on configuring this function.

Automatic PV Array Night Disconnect

When using PV Charge Control mode, the PV array is automatically disconnected from the battery at night to prevent reverse leakage of power. This eliminates the need for a blocking diode between the battery and the PV array. If thin-film or amorphous solar modules are being used, diodes may still be required to prevent damage from partial shading conditions.

Check the documentation provided with the PV modules.

Diversion Controller

The C-Series controller can operate as a Diversion Controller, also called a shunt regulator, to manage battery charging from alternative energy sources such as PV, wind or hydroelectric generators. A diversion controller monitors battery voltage and, when the voltage exceeds the settings for your charge stage (whether bulk or float), the power is diverted from the source (solar, wind, or hydro generator) to a “dump” load which will dissipate the excess power into heat.

When used for this purpose, the C-Series controller varies an amount of battery voltage to a “dump load” in order to redirect the excess power generated from over-charging the batteries. This allows the charging source to remain under constant load to prevent an over-speed condition which could occur if the charging source is suddenly disconnected from the battery—as series regulators do.

Consult your dealer for recommendations on diversion load type and regulator size.

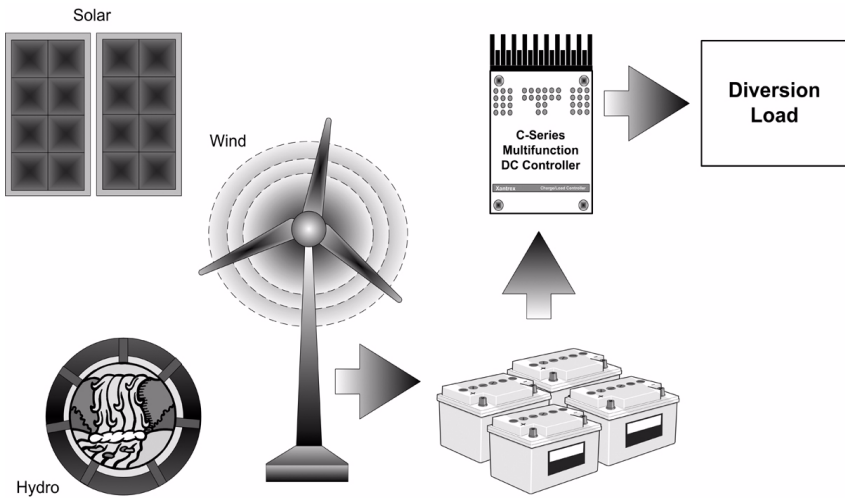

Figure 1-4 Diversion Controller

Diversion Loads

Diversion control requires a separate “dump” load to regulate the battery. This load must be able to absorb more power than the charging source is able to produce at its peak output, or the DC voltage will become unregulated. The dump load must be available for the diversion of power at all times.

Resistive-type heating elements are the best diversion loads. Special direct-current water heating elements are available. Light bulbs and motors are not recommended as diversion loads because they are unreliable. A diversion load that draws about 25% more current than the charging source’s maximum output capability is usually suitable for use with the C-Series controller.

See Appendix C, “Diversion Loads” for additional information on types of diversion loads.

See “Operating Mode Jumper” on page 20 for instructions on enabling this mode.

Important: If PV arrays are used with diversion control, it may be necessary to install diodes to prevent night-time back-feed. If in doubt, contact or consult with your local renewable energy expert.

Important: If using multiple RE sources, use diodes/isolation to prevent backfeed.



CAUTION: Damage to Batteries

Current draw of the diversion load is very important. Problems may arise from operating with a load that is too small or too large. A diversion load that is too small will not be able to absorb all the excess power from the current source once the batteries are full allowing batteries to overcharge.

Diversion loads in excess of the controller's rating are capable of absorbing more power than the C-Series controller is designed to handle, resulting in an over-current shut down. During this time, the unit will not regulate electrical flow in the system and battery damage may result.

Load Controller

The C-Series controller can operate as a Low Voltage Disconnect (LVD) for DC loads to prevent over-discharge to batteries during periods of poor charging or excessive loads. The C-Series controller uses the user-adjustable setpoints to determine when to disconnect or reconnect loads depending on battery voltage.

When used as a DC load controller, the settings of the LVR and LVD are controlled by two rotary potentiometers (also called pots) on the circuit board.

The scale on the adjustment potentiometers differ from the scale used for other functions. A decal with the appropriate adjustment scale is included with the C-Series. To apply the decal, gently pull off the knobs of the potentiometers and place this decal on the circuit board. After the decal is in place, replace the knobs. The EQ jumper determines manual

or automatic reconnect when the C-Series is used as a load controller. Do not use this decal if using the C-Series controller as a PV Charge Controller or Diversion Controller.

Low Voltage Disconnect

When configured as a load controller, the C-Series controller will disconnect the load from the batteries when it reaches the LVD setting. There will be a 6-minute delay after the voltage drops below the Low Voltage Disconnect (LVD) setting before the controller actually disconnects the load.

Low Voltage Reconnect

It can also provide automatic reconnection of the loads at the LVR (Low Voltage Reconnect) setting. Reconnection of the load is allowed once the battery voltage has exceeded the Low Voltage Reconnect (LVR) setting.

Loads are either automatically or manually reconnected when battery voltage exceeds the Low Voltage Reconnect (LVR) setting for 6 minutes.

See “Operating Mode Jumper” on page 20 for instructions on enabling this mode.

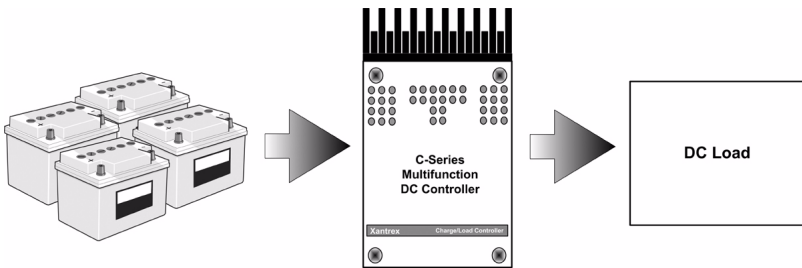

Figure 1-5 Load Controller

Important: When using the DC Load Control mode:

- Do not temperature-compensate these settings.
- Do not install the optional battery temperature compensation sensor.

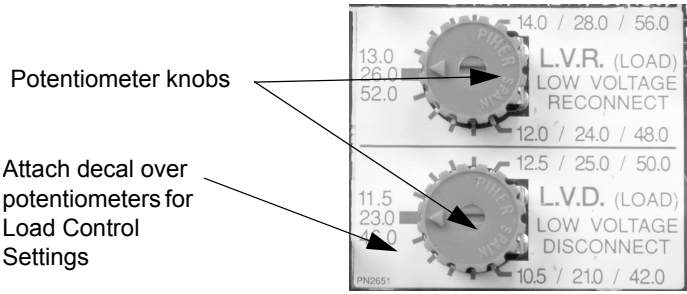

Figure 1-6 Decal Displaying Load Control Voltage Settings

Optional Accessories

The follow accessories can be purchased for use with the C-Series Multifunction DC Controller:

- **Display Meters:** The CM faceplate or CM/R remote display provide a digital display for monitoring the C-Series controller’s operation. The CM faceplate attaches directly to the front of the C-Series controller. The CM/R is intended for remote applications. These meters provide a digital display of current, voltage, amperage, and amp hours.
- **Battery Temperature Sensor (BTS):** The BTS is installed on the side of the battery and attaches to the circuit board inside the C-Series controller. It provides accurate sensing of the battery temperature and uses this reading to control charging. Using this accessory can extend battery life and improve overall charging.

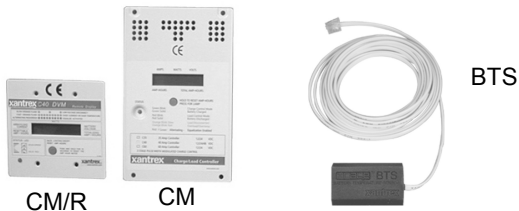

Figure 1-7 Optional Accessories - CM/R, CM, and BTS

2 Installation

Chapter 2 contains information and procedures to install C-Series Multifunction DC Controller.

For information on:	See:
“Pre-Installation”	page 14
“Mounting the Controller”	page 16
“Configuring the C-Series Controller”	page 18
“Adjusting the C-Series Voltage Settings”	page 22
“Grounding”	page 37
“Wiring”	page 38
“Installing Optional Accessories”	page 50
“Installing the Battery Temperature Sensor”	page 51

Pre-Installation

The instructions that follow are applicable to the typical installation. For special applications, consult a qualified electrician or your Xantrex Certified Dealer. Installation procedures will vary according to your specific application.

Important: *Installations should meet all local codes and standards.* Installations of this equipment should only be performed by skilled personnel such as qualified electricians and Certified Renewable Energy (RE) System Installers. For a list of Xantrex Certified RE dealers, please visit our website at www.XantrexREdealers.com.

Removing the Top Cover

Access the inside of the controller by removing the four phillips screws (#10-32 x 3/8" SMS screws) on the front cover of the unit.

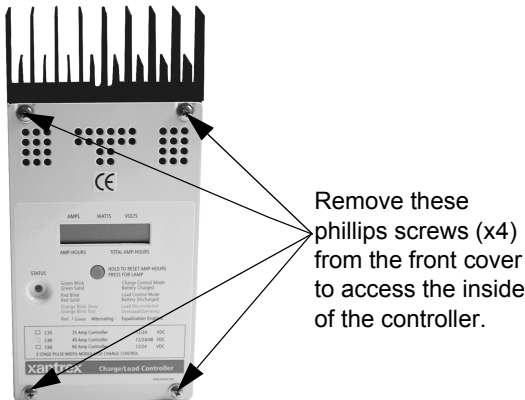
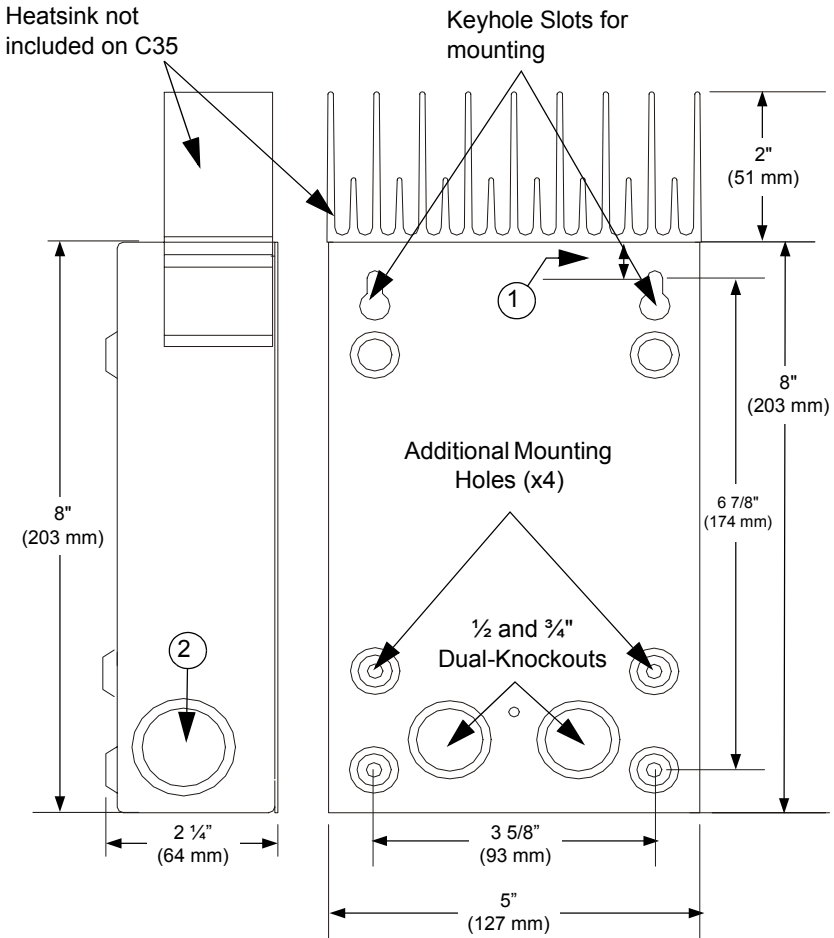

Figure 2-1 Removing the Front Cover

Removing Knockouts

Six dual-knockouts are provided to accommodate the necessary wiring of the C-Series controller. Be sure to remove any metal shavings created by removing the

knockouts before making any wiring connections. It is also recommended to use bushings or conduits to protect the wiring from damage from rough edges in the knockout holes.



- ① This distance varies per model:
 C35 = 3/8"
 C40, C60 = 5/8"
- ② 3/4 and 1"
 Dual-Knockouts (x4)
 (1 on each side and 2 on the bottom of chassis)

Figure 2-2 C-Series Dimensions and Knockout Locations (Not to Scale)

Mounting the Controller

The C-Series controller is designed for indoor mounting. Care should be taken in selecting a location and when mounting the enclosure. Avoid mounting it in direct sunlight to prevent heating of the enclosure. The enclosure should be mounted vertically on a wall.

In outdoor installations, the C-Series controller must be installed in a rainproof enclosure to eliminate exposure to rain, mist or water-spray.



CAUTION: Damage to C-Series Controller

Install the C-Series controller in a dry, protected location away from sources of high temperature, moisture, and vibration. Exposure to saltwater is particularly destructive. *Corrosion is not covered by the warranty.*

To mount the C-Series controller:

1. Remove the faceplate on the controller.
2. Place the controller on the desired mounting surface and mark the location of the keyhole slots on the wall.
3. Move the controller out of the way, and secure two mounting screws in the locations marked. Leave the screw heads backed out approximately $\frac{1}{4}$ inch (6 mm) or less.
4. Place the controller onto the screws and pull it down into the keyhole slots.
5. Then insert the two more screws in two of the four additional mounting holes provided to secure the enclosure onto the wall.
6. Provide either strain-relief clamps or conduit to prevent damage to the circuit board and terminal block from pulling on the wires.



WARNING: Explosion/Corrosion Hazard

Do not locate the C-Series controller in a sealed compartment with the batteries. Batteries can vent hydrogen-sulfide gas, which is corrosive to electronic equipment. Batteries also generate hydrogen and oxygen gas that can explode when exposed to a spark.

If using “sealed” batteries, the controller can be mounted in the same enclosure as long as it is adequately ventilated.

Place keyhole slots on the back of the controller over the mounting screws.

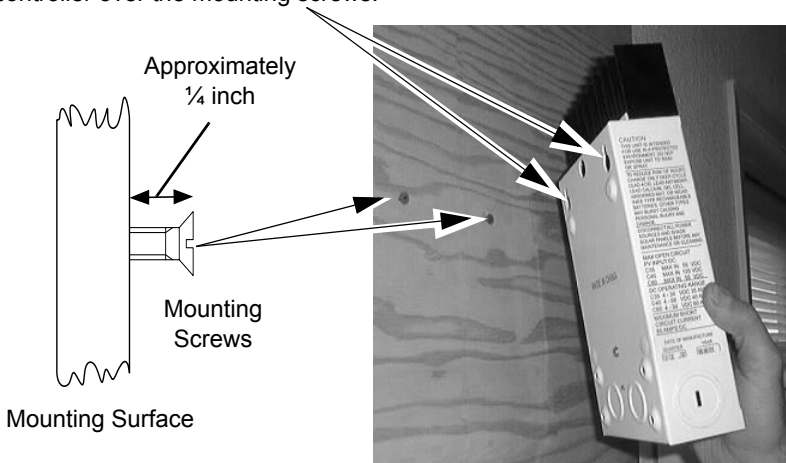

Secure in place with
2 more screws.

Figure 2-3 Mounting the C-Series Multifunction DC Controller

Configuring the C-Series Controller

Before making any wiring connections to the C-Series controller, it must be configured for the desired mode of operation. The following sections describe the how to configure the unit for the desired application and function.

Jumper Settings

Three sets of jumpers are located on the right side of the controller’s circuit board. These jumpers control equalization, low voltage reconnect, battery voltage, and operating modes. They must be installed correctly for the unit to operate to its maximum potential.

To enable a selection, carefully slide the jumper over the top of both pins. This is called installing the jumper.

To disable a selection, carefully slide the jumper over only one of the pins. This is called removing the jumper.



Jumper



Jumper Removed
(Jumper is only on one pin)



Jumper Installed
(Jumper is on both pins)

Figure 2-4 Jumper Positions

The factory default settings are shown in Table 2-1, “Factory Default Settings for C-Series Controllers” on page 19.

Important: Use extreme caution when installing and removing jumpers so as not to bend the pins.

Table 2-1 Factory Default Settings for C-Series Controllers

Setting	C35, C40 and C60
Battery Voltage	12 volts DC
Equalize/LVR	Manual Equalization
Operating Mode	Charge Control

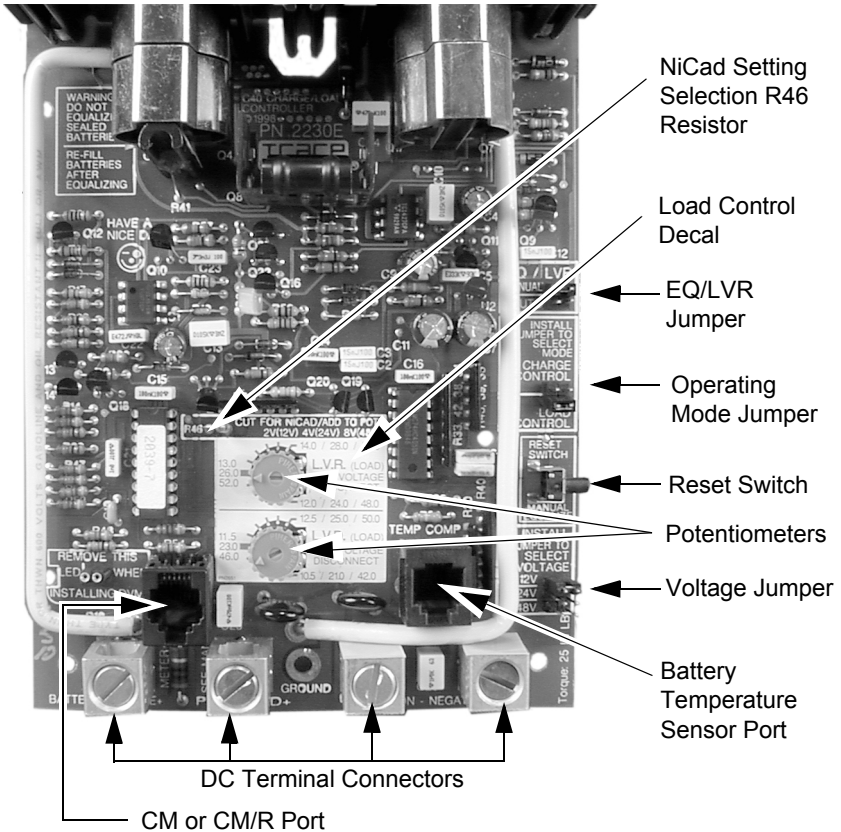

Note: This photograph shows the Load Control Voltage decal installed on the circuit board over the potentiometers.

Figure 2-5 Circuit Board Components

Operating Mode Jumper

This jumper determines the operating mode. Place the jumper over the pins that correspond to the desired mode.

- **Charge Control** (PV Charge Controller or Diversion Controller)
- **Load Control** (Load Controller)

Factory default setting is Charge Control mode.

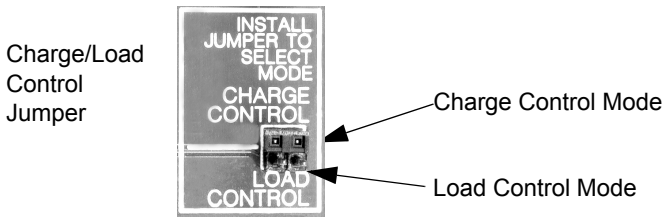

Figure 2-6 Mode of Operation Jumper

Voltage Jumper

The voltage jumper determines the voltage of the system that the controller will be used with. To set the voltage, place the jumper over the two pins adjacent to the legend for the voltage of your system: 12, 24, 48. Factory setting is 12 volts for the C35, C40, and C60.

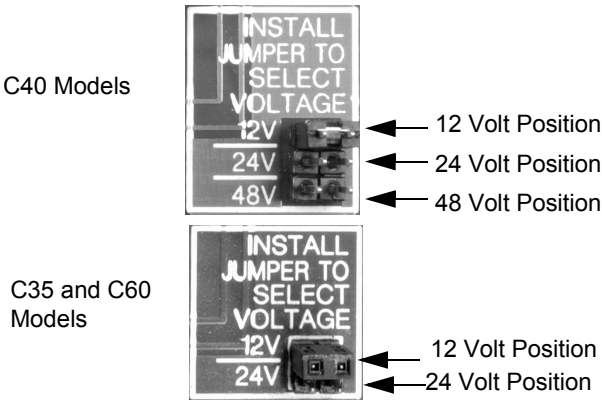

Figure 2-7 Voltage Selection Jumper

Automatic/Manual Battery Equalization (EQ) and Low Voltage Reconnect (LVR) Jumper

Depending on the mode of operation chosen, this jumper enables:

- automatic or manual battery equalization (Charge Control mode), or
- automatic or manual reconnect in the event of low voltage event (Load Control mode).

When **AUTO** is enabled in the Charge Control mode, the unit will perform an equalization charge every 30 days. This can be done manually by using Reset Switch on the side of the controller chassis.

When **AUTO** is enabled in Load Control mode, the unit will reconnect automatically when voltage at the **BATTERY POSITIVE** terminal exceeds the **LVR** setting. This can also be done manually by using Reset Switch on the side of the controller chassis.

The factory default setting is **MANUAL EQUALIZATION** (Charge Control mode).

Place the jumper over the pins for the desired selection.

EQ/LVR Jumper

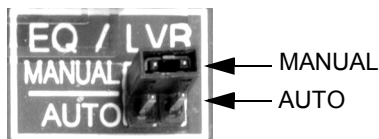

Figure 2-8 EQ/LVR Jumper and Reset Switch

See “Error Mode Indication (Orange)” on page 59 for instructions on how to use the Reset Switch in relation to this function.

Adjusting the C-Series Voltage Settings

The charging voltage setpoints and voltage reconnect/disconnect setting of the controller are adjustable using two rotary potentiometer controls. The knobs are removable to reduce the likelihood of accidental mis-adjustment if bumped.

Calibrated scales, shown as scale marks, are provided to allow setting of the control without requiring the use of a digital voltmeter.

For more information regarding bulk and float charging voltages, see “Three-Stage Battery Charging” on page 4.

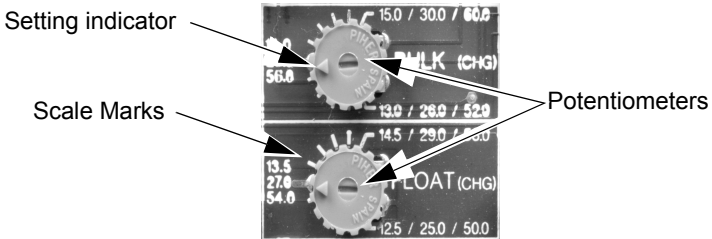

Figure 2-9 Bulk and Float Charge Potentiometers (pots)

Setting Voltage Parameters for Charge Control Mode

To set the controller to a specific voltage, point the setting indicator at the scale mark representing the desired voltage.

The potentiometer scale for BULK charge voltage is calibrated as follows:

- 12-volt system: 13.0 to 15.0 volts in increments of 0.2 volts,
- 24-volt system: 26.0 to 30.0 volts in increments of 0.4 volts,
- 48-volt system: 52.0 to 60.0 volts in increments of 0.8 volts.

For FLOAT charge voltage, the potentiometer scale is calibrated follows:

- 12-volt system: 12.5 to 14.5 volts in increments of 0.2 volts,
- 24-volt system: 25.0 to 29.0 volts in increments of 0.4 volts, and
- 48-volt system: 50.0 to 58.0 volts in increments of 0.8 volts.

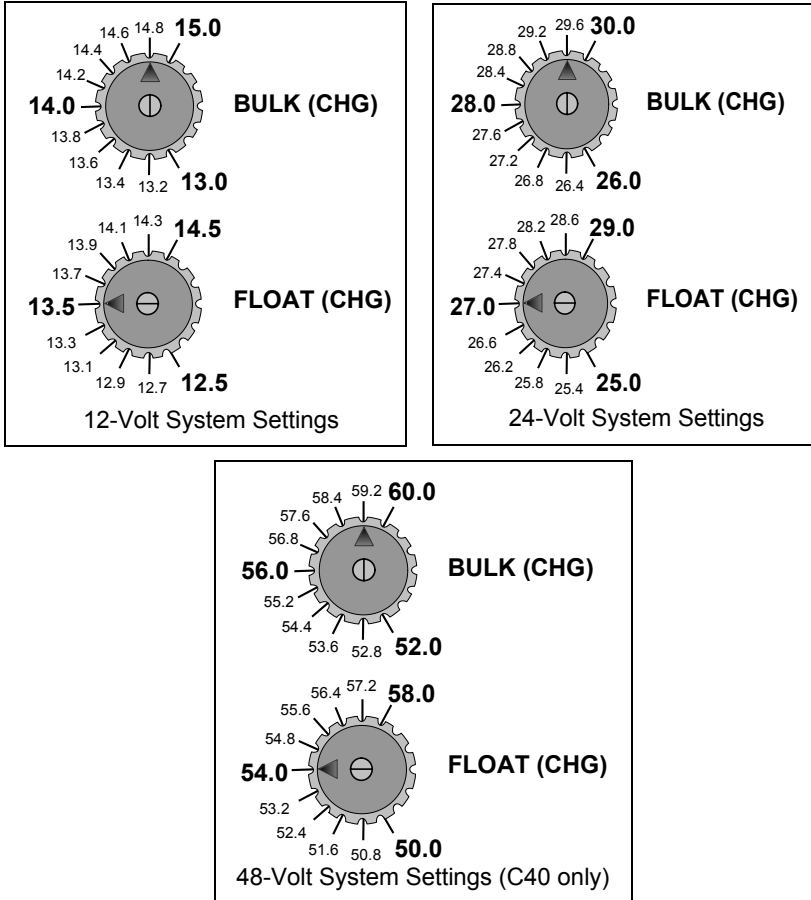

Figure 2-10 Bulk and Float Charge Settings for Charge/Diversion Control Mode

Setting Voltage Parameters for Load Control Mode

To change the Low Voltage Disconnect (LVD) and Low Voltage Reconnect (LVR) settings, use the same BULK and FLOAT potentiometers. However, when the C-Series controller is used for DC Load Control, the potentiometer's scale calibration is altered from what is printed on the circuit board.

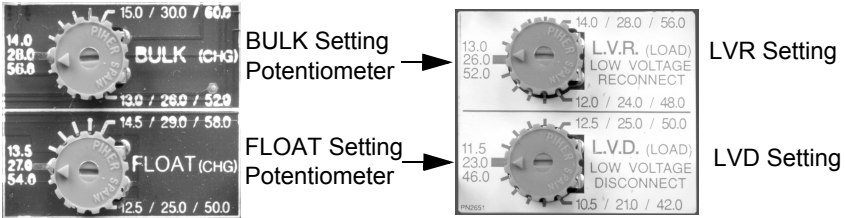

Figure 2-11 Potentiometers with Decal for LVR and LVD Settings

A decal is provided with the C-Series with the proper scale calibrations for the Load Control mode. The BULK potentiometer becomes the Low Voltage Reconnect (LVR), and the FLOAT potentiometer becomes the Low Voltage Disconnect (LVD).

Place the sticker provided over the potentiometers. The knobs may have to be removed for sticker placement, then reinstalled. The sticker is packed inside the C-Series controller (bottom of unit). If the decal is lost or unavailable, you can recalculate the appropriate voltage settings as follows:

The scale for the Low Voltage Reconnect setting is calibrated as follows:

- 12-volt system: 12.0 to 14.0 volts in increments of 0.2 volts,
- 24-volt system: 24.0 to 28.0 volts in increments of 0.4 volts,
- 48-volt system: 48.0 to 56.0 volts in increments of 0.8 volts.

The scale for the Low Voltage Disconnect setting is calibrated as follows:

- 12-volt system: 10.5 to 12.5 volts in increments of 0.2 volts,
- 24-volt system: 21.0 to 25.0 volts in increments of 0.4 volts, and
- 48-volt system: 42.0 to 50.0 volts in increments of 0.8 volts.

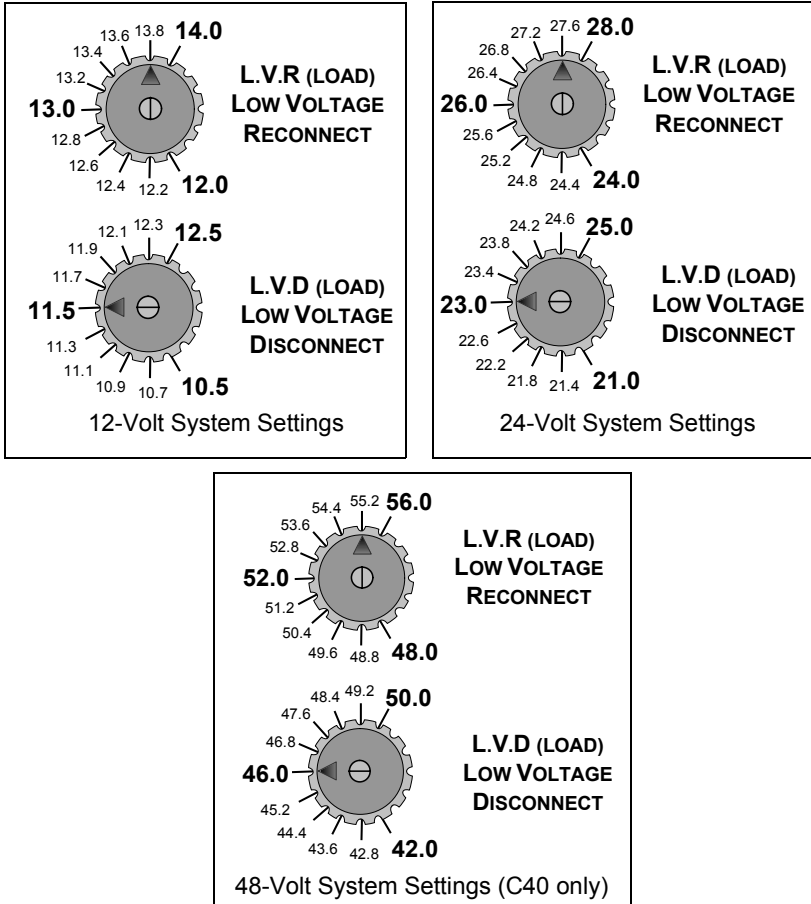

Figure 2-12 LVR and LVD Settings for Load Control Mode

Setting Voltage Parameters Diversion Control Mode

When the C-Series controller is configured for Diversion Control mode, you can set the voltage at which the unit begins diverting current to a diversion load (high voltage diversion). Use the Charge Control scale for setting this value.

See Figure 2-10 on page 23 for Charge Control scale settings.

The unit will continue diverting excess current to the diversion load until the source voltage falls to or below the BULK setting. After one hour at the BULK setting, the unit will reduce the battery charging voltage to the FLOAT voltage setting. This will usually result in more current being diverted to the diversion load.

Setting Voltage Parameters for Alkaline Batteries

If using NiCad or NiFe batteries, the required charging voltages may be higher than the designed settings of the C-Series controller. Charging voltages can be augmented a little, if required. This can be accomplished by clipping the wire connecting the R46 Resistor to the circuit board. This augmentation will raise the designed charge parameters by 2 volts for 12-volt systems, 4 volts for 24-volt systems and 8 volts for 48-volt systems.

See Figure 2-14 for the augmented voltage settings.

If using NiCad batteries, clip this wire here. Do NOT remove the R46 Resistor.

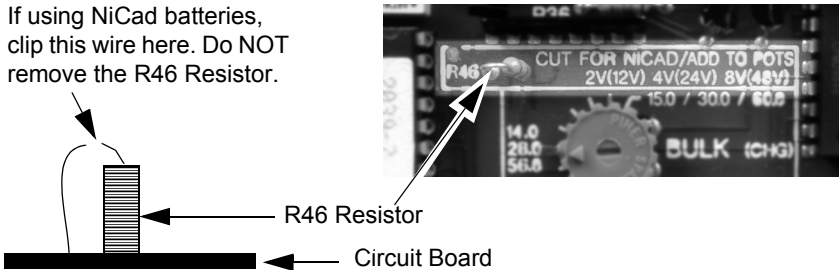

Figure 2-13 R46 Resistor Location

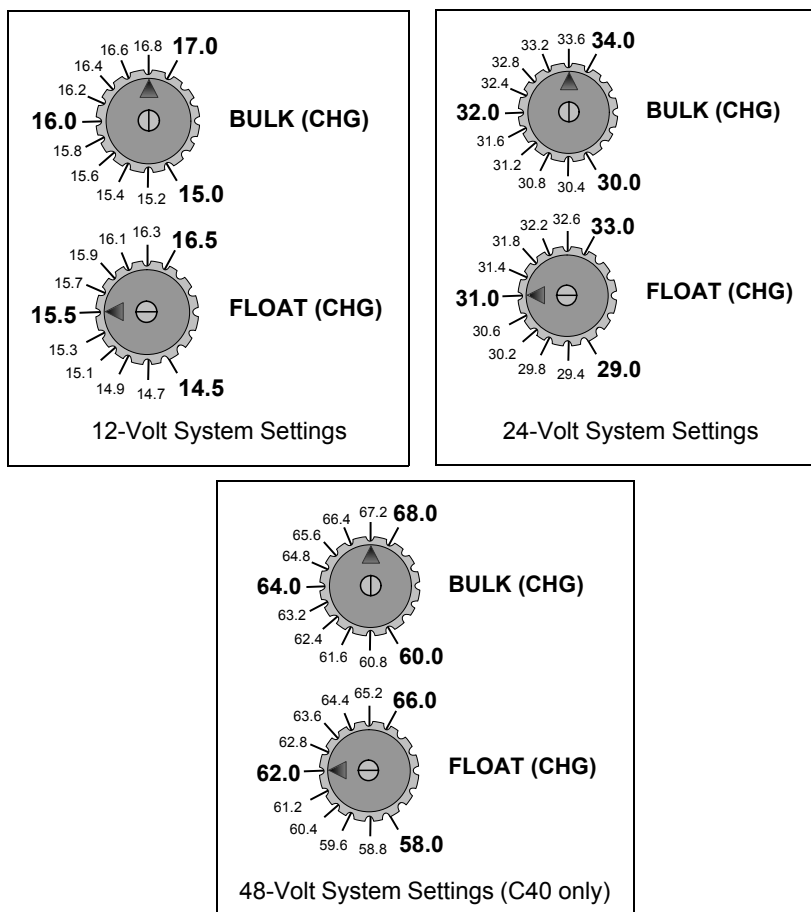

Figure 2-14 Voltage Settings with R46 Resistor Clipped



CAUTION: Damage to Batteries

It is not recommended to allow an equalize charge to occur if the R46 Resistor is clipped. Higher charging voltages may damage the batteries. Make sure the EQ/LVR jumper is on the MANUAL Setting.

Using a Digital Voltmeter to Adjust Voltage Settings

A digital DC voltmeter (DVM) can be used to provide a more accurate setting of voltage parameters. Test points are provided at the mid-range on the scales for this purpose.

The potentiometers are equipped with removable knobs to prevent accidental mis-adjustments. If the knobs are missing, a 5/64" hex-head driver can be used to adjust the settings.

To test and adjust the voltage setting using a DVM:

1. Point the potentiometers to the mid-range position.
2. Connect a digital voltmeter from one of the common negative terminals on the circuit board and the small test point located to the left of each potentiometer at the nine o'clock position. See Figure 2-15.

The test point provides a reading from 0 to 2 volts. (Multiply this value by "2" for 24-volt system and by "4" for 48-volt system.)

3. Add the value obtained in step 2 above to the lower value of the adjustment range/voltage scale being used.

For example for a 12-volt system:

To set the BULK voltage to 14.4 volts:

1. Point the BULK potentiometer to the mid-range position.
2. Adjust the potentiometer until the DVM displays 1.4 volts ($13.0\text{ V} + 1.4\text{ V} = 14.4\text{ V}$).

For example for a 24-volt system:

To set BULK voltage to 28.2 volts:

1. Point the BULK potentiometer to the mid-range position.
2. Adjust the potentiometer until the DVM displays 1.1 volts ($1.1 \times 2 [24\text{ volt}] = 2.2 + 26.0 = 28.2$).

For example for a 48-volt system:

To set BULK voltage to 56.4 volts:

1. Point the BULK potentiometer to the mid-range position.
2. Adjust the potentiometer until the DVM displays 1.1 volts ($1.1 \times 4 [48 \text{ volt}] = 4.4 + 52.0 = 56.4$).

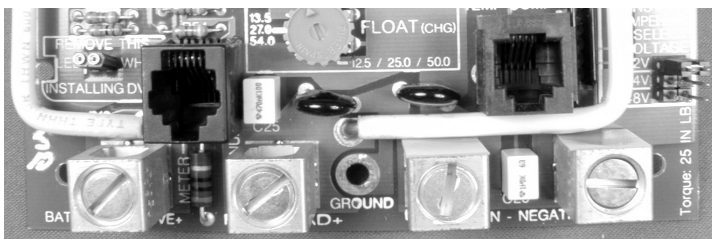
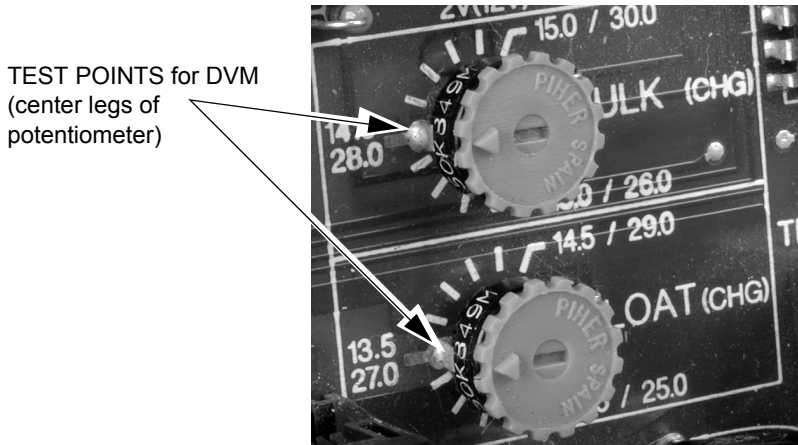

Battery Common Negative
Terminals



Figure 2-15 Test Points for Adjusting Voltage Using a DVM

Equalization Charging



CAUTION: Damage to Batteries

Equalization should be done for standard electrolyte, vented batteries only. Sealed, GEL cell, or NiCad batteries should not be equalize-charged. Consult your battery supplier for details on equalize-charging for the battery type in your system.

The C-Series offers either manual or automatic triggering of the equalization charging process. Equalization charging is the deliberate process of charging a battery (or battery bank) at a high voltage for a set period of time to remix the electrolyte and destratify the internal plates. Equalize charging helps to remove sulfate buildup on the battery plates and balances the charge of individual cells.

Equalization charging holds the voltage *above* the BULK setting for 2 hours by 1 volt for 12-volt systems, 2 volts for 24-volt systems, and 4 volts for 48-volt systems.

The default setting for this feature is MANUAL. Automatic equalization is enabled by moving the jumper located on the right side of the circuit board above the reset switch to the appropriate AUTO pin set. See Figure 2-18

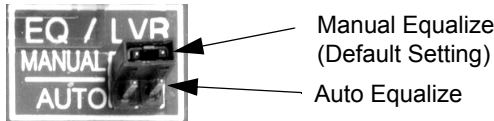

Figure 2-16 Manual Equalization Settings

When automatic has been selected, an equalization charge will occur every 30 days.

During the equalization process, the status LED indicates equalization by alternately blinking green and red.

Important: The auto equalization period is reset when DC power is removed from the controller.

Manual Equalization

Manual equalization of the battery can be enabled by pressing the Reset Switch on the right side of the C-Series until the status LED indicator begins to alternate between red and green. This could take about 10 seconds.

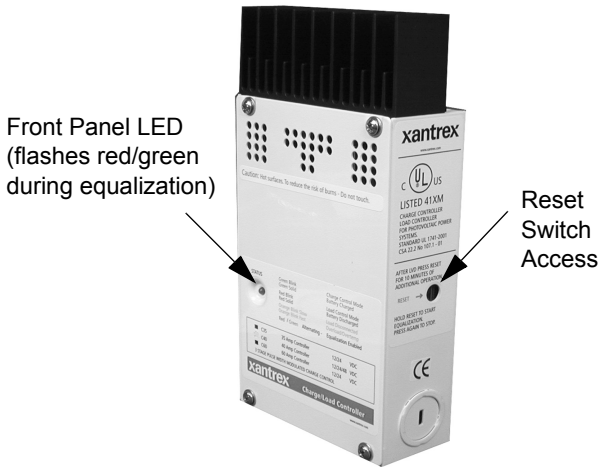

Figure 2-17 Front Panel LED and Reset Switch Location

The equalization process will continue until the batteries have been held at or above the bulk setting for two hours of accumulated time. Once the battery voltage has been at or above the bulk setting for a cumulative period of two hours, the C-Series will return to the float stage of the charging process.

During the equalization process, the status LED will alternate between red and green and will not provide any other mode/status indication. Large battery banks may need several equalization cycles to fully stir the electrolyte and charge the cells. These cycles should follow one another until the battery voltage reaches the upper limit for the full two hours.

Automatic Equalization

The C-Series controller can automatically trigger an equalization charge every 30 days. The status LED will indicate that the equalization process is occurring.

The equalization process will continue until the voltage has been held above the bulk setting for a cumulative period of two hours. This might take several days on larger systems with big batteries and small PV arrays. The battery voltage only needs to exceed the bulk setting for the timer to start counting—the voltage may not reach the equalization voltage setting.

To enable automatic equalization, the jumper located on the right side of the circuit board must be moved to the AUTO setting. The default setting of the C-Series controller is for manual equalization. To disable the automatic equalization system, move the equalize jumper to MANUAL.

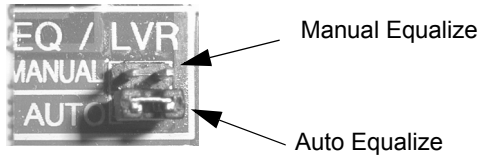

Figure 2-18 Auto Equalization Settings

Once a manual equalization has been triggered, the 30-day period to the next automatic equalization will be restarted. To prevent automatic equalization, move the equalize jumper to the manual position.

Important: It is not recommended to use the Equalization feature if the R46 Resistor is clipped.

Terminating the Equalization Process

To stop the equalization process, press the reset switch on the right side of the unit until the status LED stops alternating between red and green.

If the equalization process was shorter than one hour, the controller will continue with a bulk charge cycle and then hold the battery at the bulk setting for one hour (the absorption stage) before returning to the float setting.

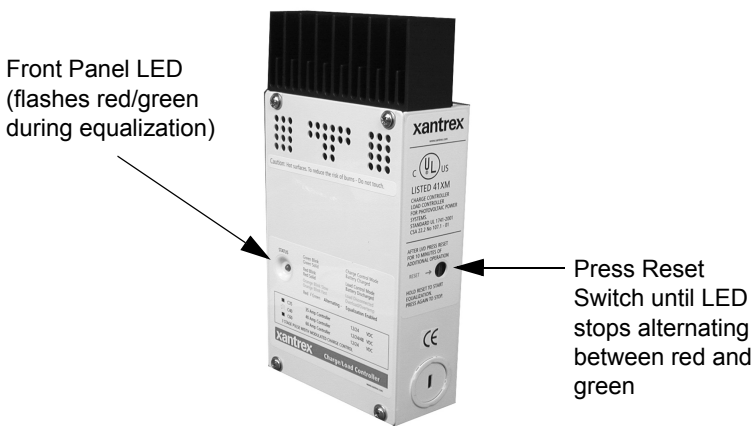

Figure 2-19 Terminating the Equalization Charge

Temperature Compensation

Important: If using the C-Series as a DC Load Controller:

- Do NOT compensate the settings.
- Do not install the Battery Temperature Sensor.

For optimal battery charging, the Bulk and Float charge rates should be adjusted according to the temperature of the battery. When battery charging voltages are compensated based on temperature, the charge voltage will vary depending on the temperature around the batteries.

Temperature Compensation Based on Battery Type

The C-Series controller uses the battery type to determine the temperature compensated voltage settings. The temperature compensated charging voltage is normally based on a Lead – Acid types of battery.

If using Alkaline-type batteries, the R46 resistor on the circuit board inside the controller will have been clipped as shown in “Setting Voltage Parameters for Alkaline Batteries” on page 26. If the R46 resistor is cut, the temperature compensation charging voltage will be based on Alkaline-type batteries.

See the battery type below to determine the temperature compensation value change per temperature or refer to the temperature compensation calculations for a Lead-Acid type battery as show in Table 2-2.

- **Lead-Acid Type Batteries:**
5 mV per cell per degree Celsius
- **Alkaline -Type Batteries (NiCad or NiFe):**
2 mV per cell per degree Celsius

Table 2-2 describes approximately how much the voltage may vary depending on the temperature of the batteries.

Automatic Battery Temperature Compensation

Temperature compensation can be accomplished automatically by using a Battery Temperature Sensor (BTS). The sensor attaches directly to the side of one of the batteries in the bank and provides precise battery temperature information.

See “Installing the Battery Temperature Sensor” on page 51 for detailed instructions on how and where to install the BTS.

If a BTS is installed, the charge controlling process will be automatically adjusted for the battery temperature. When using a BTS, set the Bulk and Float voltage for a battery at normal room temperature for 77 °F (25 °C).

Table 2-2 Variances in Charging Voltage based on Battery Temperature

Temperature (around the BTS)		12-volt units		24-volt units		48-volt units	
Celsius	Fahrenheit	Lead Acid (6 cells)	NiCad (10 cells)	Lead Acid (12 cells)	NiCad (20 cells)	Lead Acid (24 cells)	NiCad (40 cells)
60	140	-1.05	-0.70	-2.10	-1.40	-4.20	-2.80
55	131	-0.90	-0.60	-1.80	-1.20	-3.60	-2.40
50	122	-0.75	-0.50	-1.50	-1.00	-3.00	-2.00
45	113	-0.60	-0.40	-1.20	-0.80	-2.40	-1.60
40	104	-0.45	-0.30	-0.90	-0.60	-1.80	-1.20
35	95	-0.30	-0.20	-0.60	-0.40	-1.20	-0.80
30	86	-0.15	-0.10	-0.30	-0.20	-0.60	-0.40
25	77	0.00	0.00	0.00	0.00	0.00	0.00
20	68	0.15	0.10	0.30	0.20	0.60	0.40
15	59	0.30	0.20	0.60	0.40	1.20	0.80
10	50	0.45	0.30	0.90	0.60	1.80	1.20
5	41	0.60	0.40	1.20	0.80	2.40	1.60
0	32	0.75	0.50	1.50	1.00	3.00	2.00
-5	23	0.90	0.60	1.80	1.20	3.60	2.40
-10	14	1.05	1.20	2.10	1.40	4.20	2.80
-15	5	1.20	0.80	2.40	1.60	4.80	3.20
-20	-4	1.35	1.40	2.70	1.80	5.40	3.60
-25	-13	1.50	1.00	3.00	2.00	6.00	4.00
-30	-22	1.65	1.10	3.30	2.20	6.60	4.40
-35	-31	1.80	1.20	3.60	2.40	7.20	4.80
-40	-40	1.95	1.30	3.90	2.60	7.80	5.20

If using a BTS, when the battery temperature drops below 77°F (25 °C), the regulation voltage setting automatically increases. When the temperature rises above 77°F (25 °C) the regulation battery voltage setting automatically decreases.

Manual Battery Temperature Compensation

If no Battery Temperature Sensor (BTS) is installed and the batteries will be operating in very hot or very cold conditions, adjust the bulk and float settings to allow for the battery temperature.

The recommended adjustments can be made following Table 2-2. The setting should be lowered for ambient temperatures above 86 °F (30 °C) and raised for ambient temperature below 68 °F (20 °C).

If significant seasonal variations are common, you will have to change the settings several times a year to prevent battery damage and ensure proper operation.

Important: If the wiring to the sensor is damaged and the wires are shorted or cut, the system will return to the non-temperature compensated settings.

Grounding

The C-Series controller is designed to work with both negative ground and ungrounded electrical systems. The metal chassis of this charge/load controller must be grounded for either system by connecting it with a copper wire to a grounding electrode such as a ground rod driven into the earth.

If a negative ground system is desired, connect the negative current carrying conductor to the grounding system at one point in the system. Consult local and national electrical codes for more information and any additional requirements.

Telecom applications often require a positive ground system. The C-Series controller switches the PV+/LOAD+ terminal with the BATTERY POSITIVE (+) terminal. These terminals must be kept separate. You can **ONLY** ground the battery positive lead in this case, if your local jurisdiction allows it.

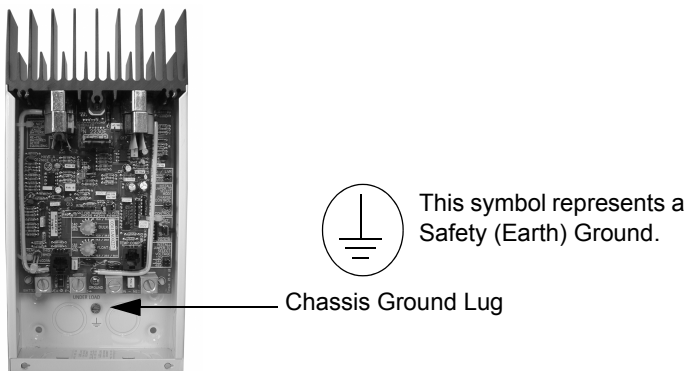

Figure 2-20 Grounding the C-Series Chassis



WARNING: Shock Hazard

Do not disconnect the chassis ground if loads are engaged.

Wiring

Important: *Installations should meet all local codes and standards.* Installations of this equipment should only be performed by skilled personnel such as qualified electricians and Certified Renewable Energy (RE) System Installers. For a list of Xantrex Certified RE dealers, please visit our website at www.XantrexREdealers.com.



WARNING: Shock Hazard

Disconnect battery and PV sources before wiring.



CAUTION: Damage to Batteries

Ensure the voltage selection jumper is set properly before energizing the system. Incorrect settings may result in damage to the system as charging regulation will not occur.

DC Terminal Connector Locations

Terminal connectors for DC wiring are located on the lower edge of the circuit board. See Figure 2-21.

Important: Regardless of the configuration, only the positive conductor from a PV array **OR** a DC load may be connected to the terminal marked “PV+/LOAD+”.

The common negatives can be reversed or wired with an appropriately sized single conductor to a more convenient location such as a DC load center negative bus, if necessary.

The shunt used to measure the current flow in the C-Series controller is located in the positive conductor of the circuit allowing greater flexibility in system grounding. The negative terminals are all common to one another.

Terminal Torque Requirements

Once the wires have been installed, torque the terminals as follows. Be careful not to overtighten.

- 20 inch-pounds for #14-10 AWG wire
- 25 inch-pounds for #8 AWG wire
- 35 inch-pounds for #6 AWG wire

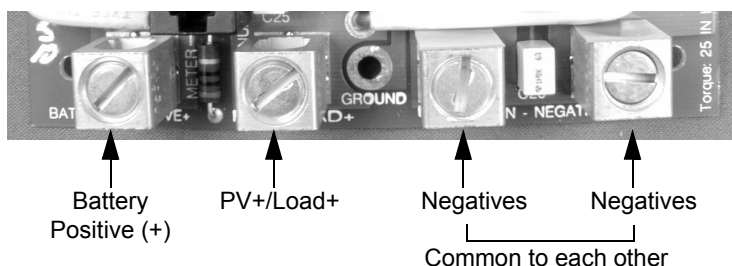

Figure 2-21 DC Connection Terminals

Wire Size and Over-current Protection Requirements

The wiring, over-current protection devices (fuses and circuit breakers), and installation methods used must conform to all national and local electrical code requirements.

Wiring should be protected from physical damage with conduit or a strain relief clamp. You should pull the temperature sensor cable through the conduit first as the connector may not fit if other wires have been pulled first.

Current Rating

Each model of the C-Series controller is rated for a maximum continuous current of 35, 40 or 60 amps. *Since PV outputs can vary due to the array size or sunlight striking it, the safe minimum wire size should be based on the maximum current ratings.*

Minimum Recommended Wire Gauge

The minimum recommended wire gauge is:

- **C35 and C40 Models:**
#8 AWG with a 75 °C (167 °F) insulation rating
- **C60 Models:**
#6 AWG, with a 90 °C (194 °F) insulation rating

The terminals on the C-Series will accept up to #2 AWG (33.6 mm²) copper or aluminum wire. However, UL specifications only allow the use of up to #6 AWG (13.3 mm²) maximum.

No crimp-on terminals or lugs are required.

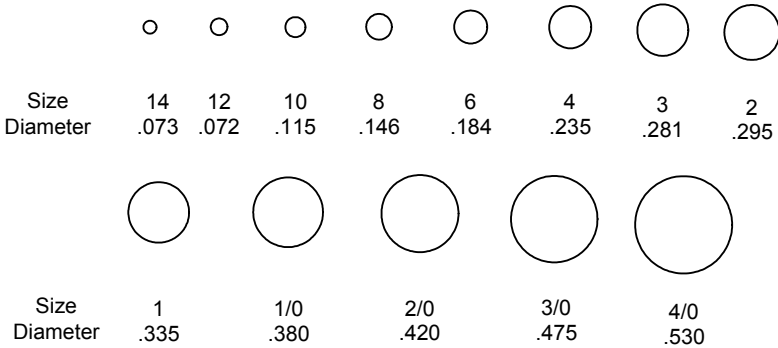

Figure 2-22 AWG Wire Gauge Reference Chart

Important: Figure 2-22 is for reference only. Sizes shown are for the conductor. Do not include any insulation when determining your wire size. *Due to printing anomalies, these dimensions may not be to scale.*

Surge Protection

Since PV arrays are often mounted on an elevated structure and thus are more susceptible to lightning strikes, protection from lightning-induced power surges and other transient power disturbances between the PV array and the C-Series

controller are strongly recommended. Put a surge protection device on the input line of the C-Series controller between the PV array and the controller.

If the battery, is over 15 feet away from the controller, or if it is routed next to other wiring or sources of power, additional surge protection devices are recommended. Put the surge protection device for this scenario on the battery input line between the battery and the controller.

Over-current Protection

The NEC requires conductors and over-current devices be operated at no more than 80% of their rating. Refer to Table 2-3 for a listing of the minimum wire size and over-current device ratings to be used for each model.

As a minimum, a 60-amp DC-rated current-limiting fuse or circuit breaker should be installed near the battery for protection from short circuits. To meet NEC requirements, use a 60 amp circuit breaker listed for 100% duty for the C60. To meet UL requirements, use #6 AWG copper wires rated for 90 °C (194 °F) for the C60. Over-current protection for the battery circuit is to be provided by others. Refer to Table 2-3 for the correct ratings of the fuse and circuit breaker.

Table 2-3 Minimum Wire Size

Controller	Minimum Wire Size	Over-Current Device Rating
C35	#8 AWG	45 amps
C40	#8 AWG	50 amps
C60 ^a	#6 AWG (90 °C/194 °F wire)	60 amps (listed 100% duty)
C60	#4 AWG ^b (75 °C/167 °F wire)	60 amps (listed 100% duty)

a. To meet UL requirements, use #6 AWG, (90 °C/194 °F) wire and a 60 amp Listed 100% duty over-current device for the C60 controller.

b. Not approved by UL for direct connection into the controller. Use a splicer block and #6 AWG (90 °C/194 °F) wire to connect to the controller terminals.

Long-distance wire runs

If there is a significant distance between the PV array and the controller and/or the controller and the battery, larger wires can be used to reduce the voltage drop and improve performance. Refer to Table 2-4.

To use a larger size wire, use a splicer block (terminal block) intended for this purpose. This allows the larger cable size from the batteries to be “spliced” to the smaller wire size connected to the controller. Split-bolt kerneys can also be used for wire splices.

Follow manufactures recommendations for torque and mounting (if required). Splicer blocks and split-bolt kerneys are available from renewable energy suppliers.

Maximum One-way Distance and Wire Size

Important: NEC Article 690 and local electrical codes should be consulted for wire sizing and any additional installation requirements.

- For a C60 use a 60 amp, 100% Continuous Duty breaker and #6 AWG, 90 °C wire.
 - Larger wire sizes may be used to improve performance, but are NOT approved by UL to be installed in the controller. Use a splicer block as previously described.
-

Refer to Table 2-4 and find your maximum current in the left column, and the one-way distance from your power source (feet/meters) to the C-Series controller (or the distance from the C-Series controller to your load) on the same line, then read the wire size required at the top of the column.

Table 2-4 One-Way Wire Distance and Wire Size

**Maximum One-way Wire Distance for a < 3% Voltage drop
12 Vdc Application Shown
For 24 Vdc Systems, Multiply distance by 2
For 48 Vdc Systems, Multiply distance by 4**

Amps	Distance in Feet (meters)				Distance in Feet (Meters) ^a						
	12 AWG	10 AWG	8 AWG	6 AWG	4 AWG	3 AWG	2 AWG	1 AWG	1/0 AWG	2/0 AWG	
10	8.8 ft. (2.68 m)	14 ft. (4.27 m)	22.2 ft. (6.77 m)	35.3 ft. (10.76 m)	56.1 ft. (17.10 m)	70.9 ft. (21.61 m)	89.6 ft. (27.31 m)	112.5 ft. (34.29 m)	141.7 ft. (43.19 m)	225.8 ft. (68.82 m)	
12	7.3 ft. (2.23 m)	11.6 ft. (3.54 m)	18.5 ft. (5.64 m)	29.4 ft. (8.96 m)	46.7 ft. (14.23 m)	59.1 ft. (18.01 m)	74.6 ft. (22.74 m)	93.7 ft. (28.56 m)	118.1 ft. (36.00 m)	188.2 ft. (57.36 m)	
14	6.3 ft. (1.92 m)	10 ft. (3.05 m)	15.9 ft. (4.85 m)	25.2 ft. (7.68 m)	40.1 ft. (12.22 m)	50.6 ft. (15.42 m)	64.0 ft. (19.51 m)	80.4 ft. (24.51 m)	101.2 ft. (30.85 m)	161.3 ft. (49.16 m)	
16	5.5 ft. (1.68 m)	8.7 ft. (2.65 m)	13.9 ft. (4.24 m)	22.1 ft. (6.74 m)	35.0 ft. (10.67 m)	44.3 ft. (13.50 m)	56.0 ft. (17.07 m)	70.3 ft. (21.43 m)	88.6 ft. (27.01 m)	141.2 ft. (43.04 m)	
18	4.9 ft. (1.49 m)	8.8 ft. (2.38 m)	12.4 ft. (3.78 m)	19.6 ft. (5.97 m)	31.2 ft. (9.51 m)	39.4 ft. (12.01 m)	49.8 ft. (15.18 m)	62.5 ft. (19.05 m)	78.7 ft. (23.99 m)	125.5 ft. (38.25 m)	
20	4.4 ft. (1.34 m)	7 ft. (2.13 m)	11.1 ft. (3.38 m)	17.6 ft. (5.36 m)	28.0 ft. (8.53 m)	35.4 ft. (10.79 m)	44.8 ft. (13.66 m)	56.2 ft. (17.13 m)	70.9 ft. (21.61 m)	112.9 ft. (34.41 m)	
25		5.6 ft. (1.71 m)	8.9 ft. (2.71 m)	14.1 ft. (4.30 m)	22.4 ft. (6.83 m)	28.3 ft. (8.63 m)	35.8 ft. (10.91 m)	45.0 ft. (13.72 m)	56.7 ft. (17.28 m)	90.3 ft. (27.52 m)	
30		4.7 ft. (1.43 m)	7.4 ft. (2.26 m)	11.8 ft. (3.60 m)	18.7 ft. (5.70 m)	23.6 ft. (7.19 m)	29.9 ft. (9.11 m)	37.5 ft. (11.43 m)	47.2 ft. (14.39 m)	75.3 ft. (22.95 m)	
35			6.4 ft. (1.95 m)	10.1 ft. (3.08 m)	16.0 ft. (4.88 m)	20.2 ft. (6.16 m)	25.6 ft. (7.80 m)	32.1 ft. (9.78 m)	40.5 ft. (12.34 m)	64.5 ft. (19.66 m)	
40			5.6 ft. (1.71 m)	8.8 ft. (2.68 m)	14.0 ft. (4.27 m)	17.7 ft. (5.39 m)	22.4 ft. (6.83 m)	28.1 ft. (8.56 m)	35.4 ft. (10.79 m)	56.5 ft. (17.22 m)	
45				7.8 ft. (2.38 m)	12.5 ft. (3.81 m)	15.7 ft. (4.79 m)	19.9 ft. (6.07 m)	25.0 ft. (7.62 m)	31.5 ft. (9.60 m)	50.2 ft. (15.30 m)	
50				7.1 ft. (2.16 m)	11.2 ft. (3.41 m)	14.2 ft. (4.33 m)	17.9 ft. (5.46 m)	22.5 ft. (6.86 m)	28.3 ft. (8.63 m)	45.2 ft. (13.78 m)	
60				6.3 ft. (1.92 m)	9.3 ft. (2.83 m)	11.8 ft. (3.60 m)	14.9 ft. (4.54 m)	18.7 ft. (5.7 m)	23.6 ft. (7.19 m)	37.6 ft. (11.5 m)	

a. These wire sizes are not approved by UL to be installed in the controller, but may be used externally of the controller (using a splicer block) to reduce voltage drop and improve performance.

PV Charge Control Mode Wiring

The procedure below is illustrated in Figure 2-23.



WARNING: Shock Hazard

PV arrays generate voltage whenever light strikes the surface of the array. Before connecting the C-Series controller, cover or disconnect the array to prevent any current from being generated.

To connect the C-Series controller as a charge controller:

1. Connect the PV array's positive (+) output to the PV array disconnect.
2. Route another (+) cable from the other end of the RE disconnect to the PV GFP.
3. Route another (+) cable from the same switch in the PV GFP to the terminal marked PV POS/LOAD in the C-Series controller.
4. Connect the PV array's negative (-) output to the terminal marked COMMON NEGATIVES.
5. Connect another negative (-) cable from the other COMMON NEGATIVES to the Negative bus in the DC disconnect.
6. Route a negative (-) wire from the PV GFP to the Negative bus in the DC disconnect.
7. Connect a positive (+) cable from terminal marked BAT POS to the battery disconnect in the DC disconnect.
8. Connect a second positive (+) cable to the other side of the battery disconnect in the DC disconnect and connect to the positive (+) battery terminal.
9. Connect the negative (-) battery cable to the negative bus in the DC disconnect and tighten the lugs.
10. Tighten per torque requirements outlined on page 39. Allow a little slack on the cables within the controller and secure the wiring with strain reliefs.

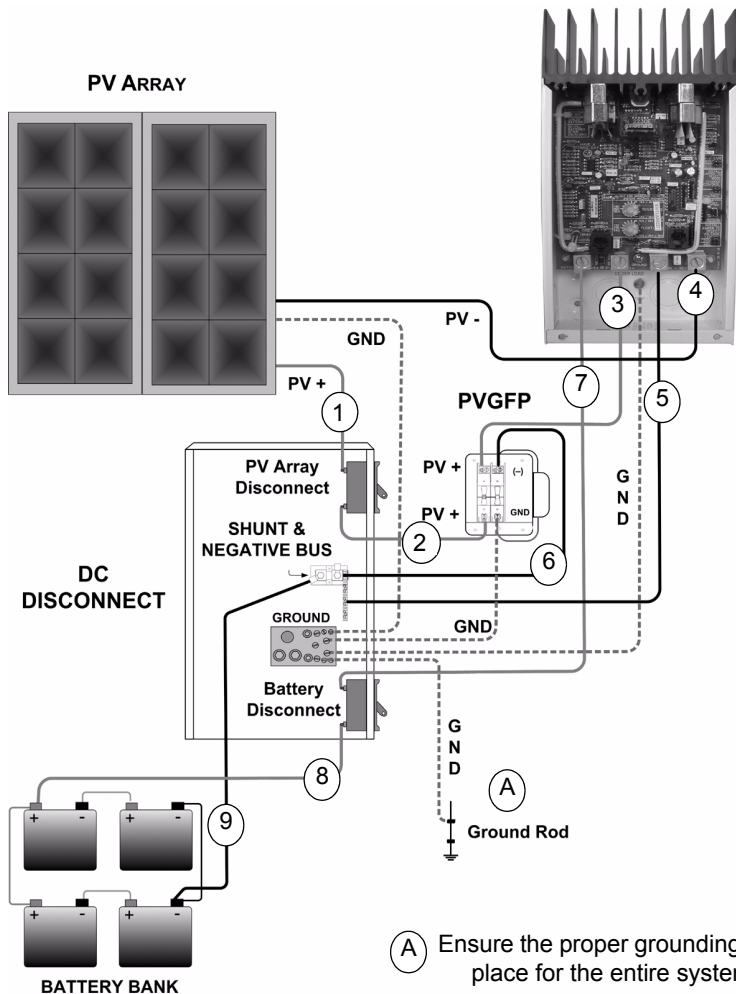
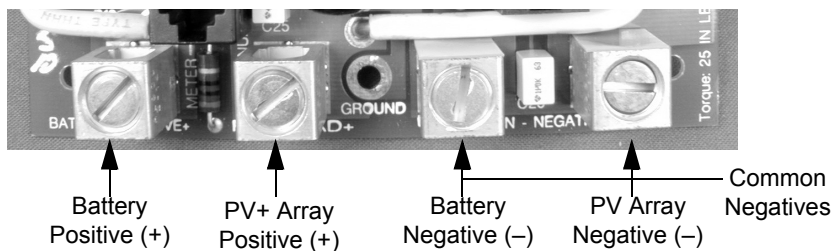

(A) Ensure the proper grounding is in place for the entire system.

Figure 2-23 PV Charge Control Mode Wiring

Diversion Control Mode Wiring

The procedure below is illustrated in Figure 2-24.

When using the C-Series unit as a Diversion or DC Load Controller, the DC load needs to be connected to the controller terminals marked as PV +/-LOAD+ and COMMON NEGATIVE.

To connect the C-Series as a diversion load controller:

1. Connect your DC current source (PV, wind, hydro, etc.) directly to the RE disconnect.
2. Connect another cable from the other side of the RE disconnect to the battery positive terminal.
3. Run a negative wire from the DC current source (PV, wind, hydro, etc.) to the battery negative terminal.
4. Connect a cable from controller terminal marked BAT POS to the battery disconnect.
5. Connect a cable from the battery disconnect to the positive terminal of the battery.
6. Connect a cable from the negative battery terminal to one of the terminals marked COMMON NEGATIVES on the controller's circuit board.
7. Connect a cable from the controller's other terminal marked COMMON NEGATIVES to the negative terminal of your DC diversion load.
8. Connect a cable from the controller's terminal marked PV+/-LOAD+ to the positive terminal of your DC diversion load.
9. Tighten per torque requirements outlined on page 39. Allow a little slack on the cables within the controller and secure the wiring with strain reliefs.

Important: Do not use light bulbs for diversion loads. Use only resistive loads such as air- or water-cooled heating elements

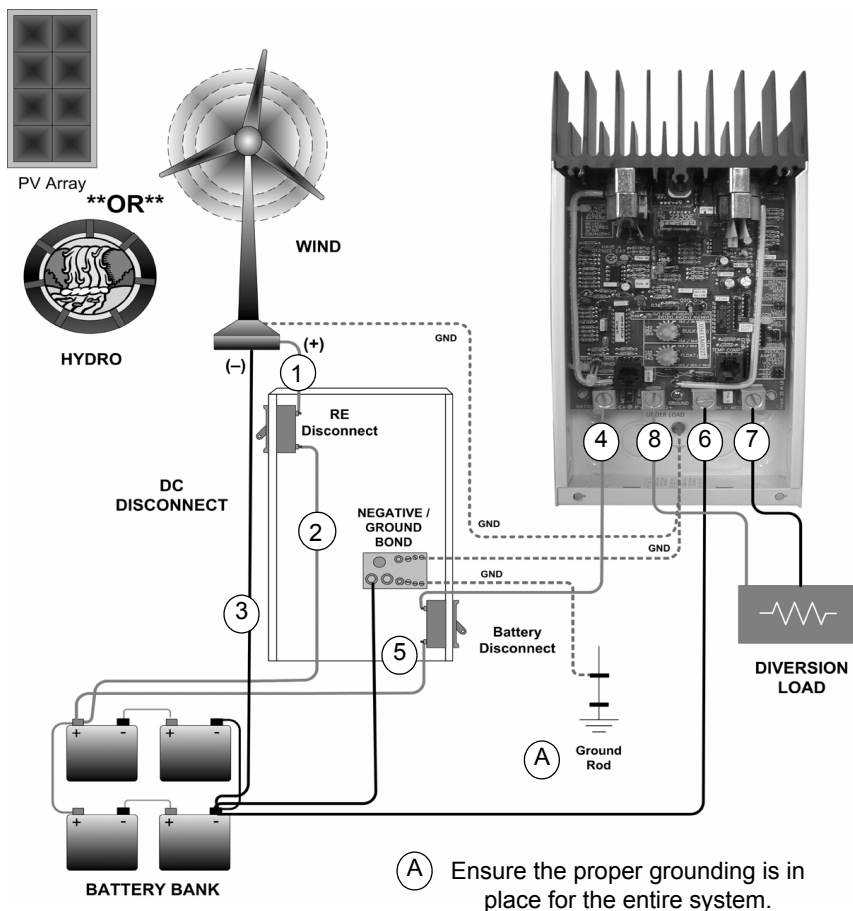
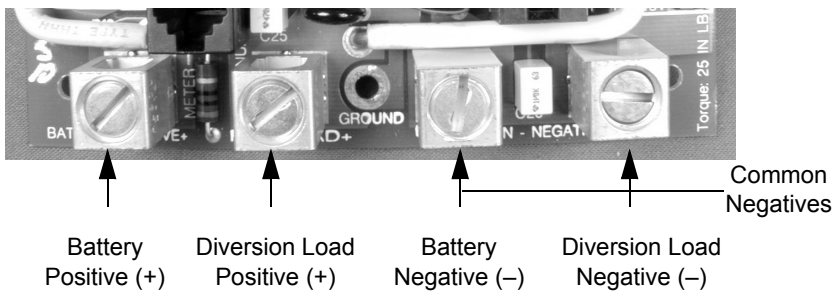

Figure 2-24 Diversion Control Mode Wiring

DC Load Control Mode Wiring

The procedure below is illustrated in Figure 2-25.

To connect the C-Series controller as a DC load controller:

1. Connect a cable from the BAT POSITIVE terminal on the controller to a battery disconnect.
2. Connect the positive battery cable to the battery disconnect.
3. Connect the negative battery cable to the one of the terminals marked COMMON NEGATIVES.
4. Connect a cable between the PV POS/LOAD terminal on the controller and the positive terminal on the DC load.
5. Connect a cable between the controller's other COMMON NEGATIVES terminal and to the negative terminal of the load.
6. Tighten per torque requirements outlined on page 39. Allow a little slack on the cables within the controller and secure the wiring with strain reliefs.

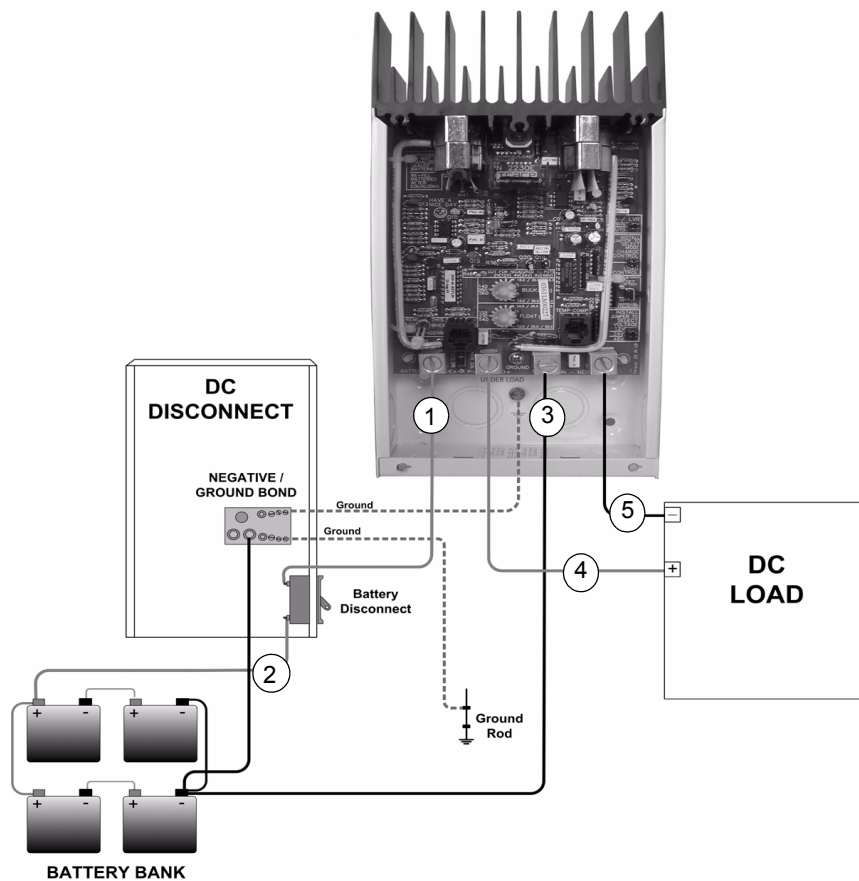
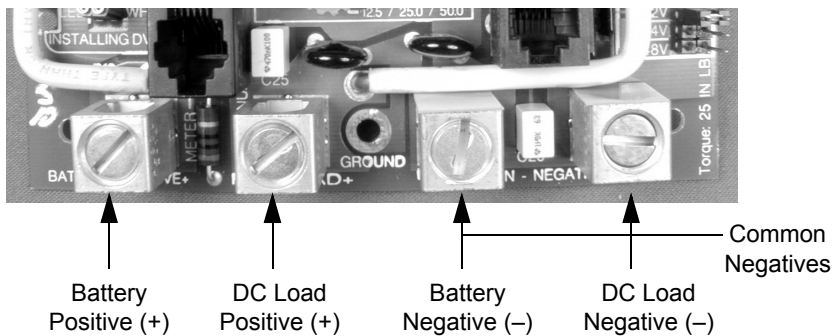

Figure 2-25 Load Control Mode Wiring

Installing Optional Accessories

The following sections describe how to install the optional accessories available for the C-Series Multifunction DC Controller.

Installing a Digital Display

Follow the instructions in the C-Series Meter Displays Installation Guide for preparing the CM or CM/R for installation.

The display will connect to the controller at the RJ-15 port on the lower left corner of the circuit board.

Important: Ensure the voltage jumpers on the back of the CM or CM/R match the system voltage as configured inside the controller unit. See the C-Series Meter Displays Installation Guide for additional information.

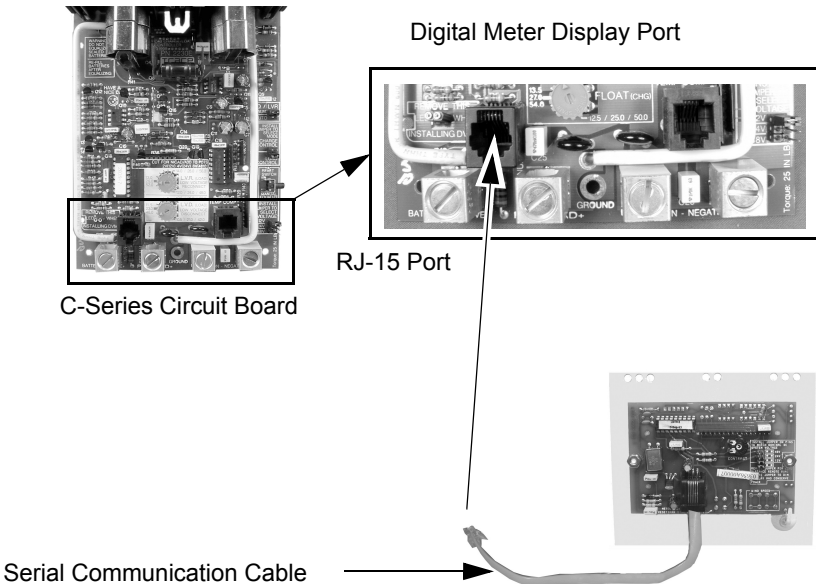

Figure 2-26 Installing a Digital Display

Installing the Battery Temperature Sensor

To install the BTS:

1. Install the BTS on the side of the battery below the electrolyte level. It is best to place the sensor between batteries and place the batteries in an insulated box to reduce the influence of the ambient temperature outside the battery enclosure.
2. Insert the RJ-11 plug on the other end of the BTS into the BTS Port on the lower right corner of the circuit board inside the C-Series controller.

Important: Ventilate the battery box at the highest point to prevent hydrogen accumulation.

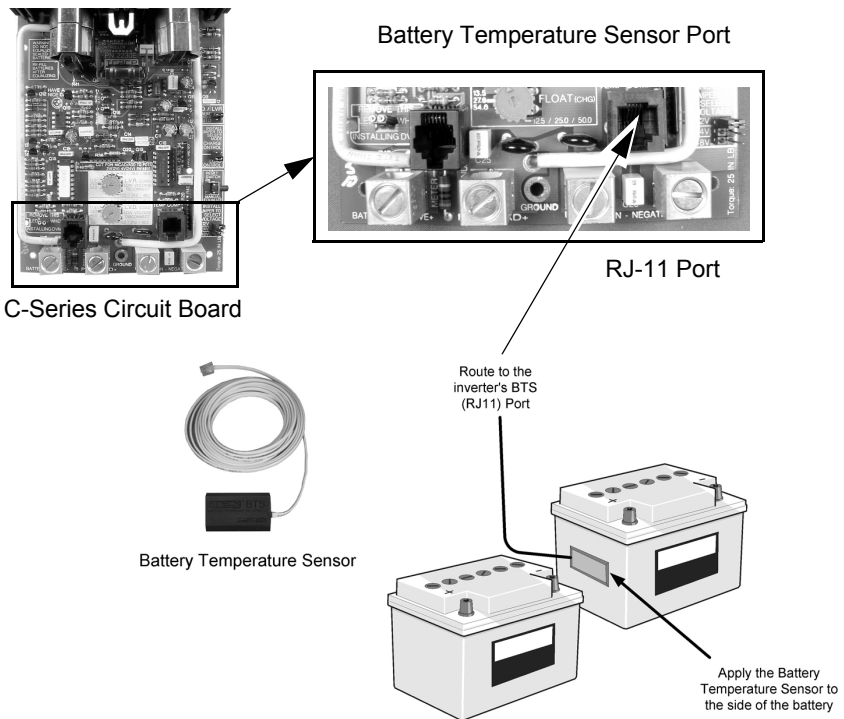

Figure 2-27 Installing the BTS

Reinstalling the Faceplate

To reinstall the faceplate on the C-Series controller:

1. Align faceplate with front of chassis so that screw holes in the corners line up.
2. Insert the phillips screws into the screw holes and tighten.

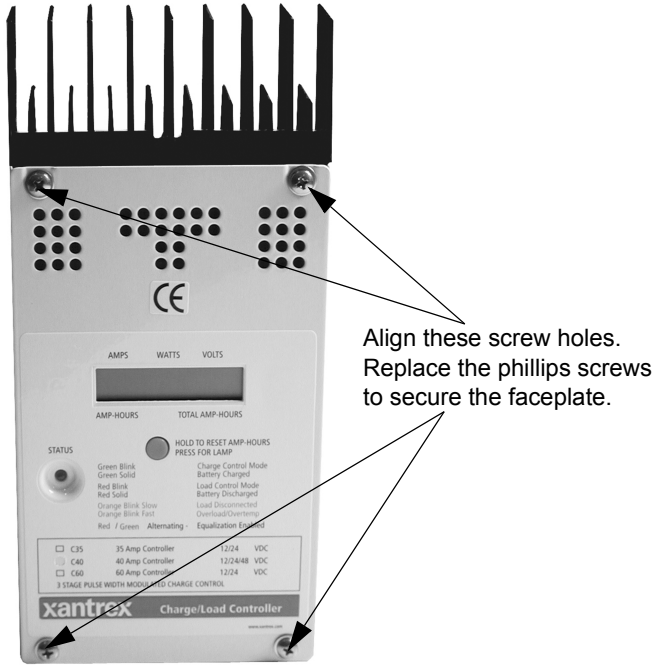

Figure 2-28 Re-installing the CM Faceplate

3 Operation

Chapter 3 contains information about the operation of a C-Series Multifunction DC Controller.

For Information on:	See:
“Basic Operation”	page 54
“LED Status Indicator”	page 55
“Charge Control or Diversion Control Indications (Green)”	page 56
“Load Control Indications (Red)”	page 58
“Error Mode Indication (Orange)”	page 59
“Reconnecting to Loads”	page 60

Basic Operation

The C-Series controller (all models) has one multicolor LED status indicator and one reset button.

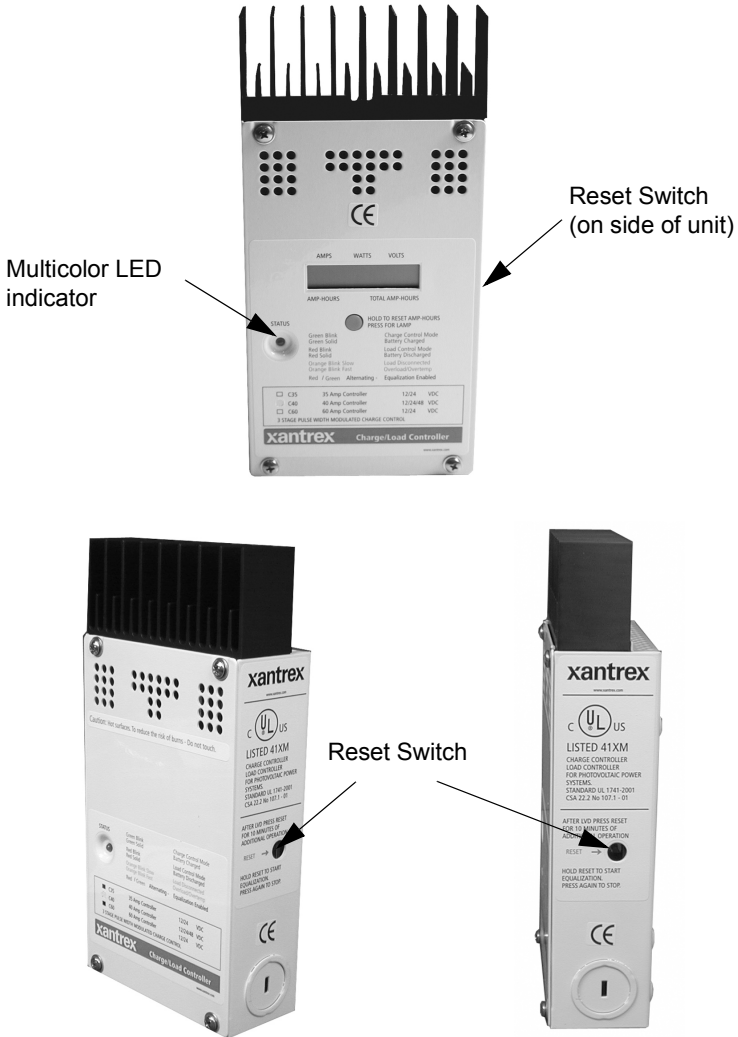

Figure 3-1 C-Series Status LED and Reset Button Location

LED Status Indicator

The multicolor LED on the base unit, or the optional CM faceplate or CM/R remote, indicates the operating status of the controller. A color-coded label is included on the cover of the controller explaining the status LED's indications.

- When in Charge Control mode, the LED will be green.
- When in Load Control mode, the LED will be red.
- When an Error Condition exists or the load has disconnected, the LED will be orange.
- When battery equalization is in process, the LED alternates between red and green.

Important: The green and red color of the LED only indicates the particular operating mode and the battery voltage level. It does not indicate whether the charging source is functioning properly

Multicolor LED indicator

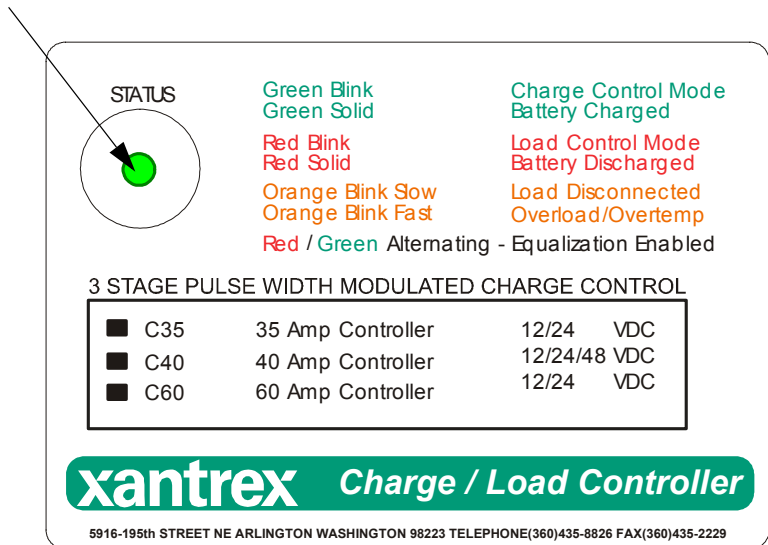

Figure 3-2 C-Series Front Panel Label

Table 3-1 Battery Voltage LED Indicators

Green LED (Charge/Diversion Mode)			LED Status	Red LED (Load Control Mode)		
Battery at FLOAT Setting			Always ON	Battery at LVD Setting (for 6 minutes = LVD)		
Battery at BULK Setting			5 blinks	> 0.15 above LVD	>0.03 above LVD	>0.45 above LVD
BULK Setting Minus (-)				LVD Setting Plus (+)		
0.25 Vdc	0.50 Vdc	1.00 Vdc	4 blinks	0.15 Vdc	0.30 Vdc	0.45 Vdc
0.50 Vdc	1.00 Vdc	2.00 Vdc	3 blinks	0.30 Vdc	0.60 Vdc	0.90 Vdc
0.75 Vdc	1.50 Vdc	3.00 Vdc	2 blinks	0.45 Vdc	0.90 Vdc	1.35 Vdc
> 0.75 below Bulk	> 1.50 below Bulk	> 3.00 below Bulk	1 blink	> 0.45 below Bulk	> 0.90 below Bulk	> 1.375 below Bulk
12 volts	24 volts	48 volts	DC Voltage	12 volts	24 volts	48 volts

Charge Control or Diversion Control Indications (Green)

The flashing rate of the LED indicates the controller’s stage of operation and approximate battery voltage.

- One to four flashes indicates the controller is in the Bulk stage. As the flashing rate increases, the batteries are progressively closer to the Bulk voltage. Table 3-1 indicates the approximate level the battery is below the Bulk setting.
- Five flashes indicates the controller has reached Bulk voltage and is in the Absorption stage.
- Solid green means the controller is in the Float stage and is regulated at the Float voltage.

For example, if the system battery voltage is 24 volts and the internal Bulk voltage setting is set for 28 volts, you can estimate how much below the Bulk setting the batteries are by subtracting the number in Table 3-1 (the internal Bulk setting).

With the LED indicating three blinks, the battery voltage is approximately 27 volts (28 volts Bulk setting minus 1.00 volts in the table).

With the LED indicating one blink, the battery voltage is *somewhere below* 26.5 volts (28 volts Bulk setting minus >1.50 volts in the table).

Important: LED will light green only in Diversion and Charge Control mode (unless it is reinstalled backwards).

Blinking Green

The controller is in the Charge Control or Diversion Control mode and the battery is not fully charged. As the battery voltage approaches the BULK setting, the status LED will blink green several times (up to five) and then pause, indicating the battery voltage is approaching the bulk setting and provides an indication of the battery condition. Refer to Table 3-1 to determine the battery voltage.

Important: A single green flash indicates the battery is well below the bulk voltage setting. It does NOT indicate the batteries are charging or their state-of-charge.

Solid Green

The battery is being charged in the FLOAT stage. The status LED remains ON solid unless the batteries drop below the float voltage setting for an accumulative period of one hour. This allows the user to confirm that the system reached the float stage during the charging process when checked at the end of the day. Reaching the float stage frequently is a good indication of proper system operation and will maximize battery life and performance.

Equalization Mode Indication (Red/green)

Be sure to read all cautions and warning regarding equalization charging batteries BEFORE allowing an equalization charge to occur. Damage to batteries can occur.

Alternating Red and Green

The controller is in the EQUALIZE mode.

It will automatically stop the equalization process after accumulating two hours of operation at a voltage above the BULK setting.

The user can manually stop the equalization process at any time by pressing the reset switch until the status LED stops alternating red and green.

Load Control Indications (Red)

The flashing rate of the LED indicates the controller's stage of operation and approximate battery voltage.

Blinking Red

As battery voltage approaches the LVD setting, the LED will blink red several times (up to five) and then pause providing an indication of battery voltage. Refer to Table 3-1 to determine the battery voltage.

Solid Red

The controller is in the Load Control mode and the battery voltage has reached the Low Voltage Disconnect (LVD) setting. After a 6-minute delay, DC loads will be disconnected unless the user reduces the loads to a point that the battery voltage exceeds the LVD setting.

Error Mode Indication (Orange)

The C-Series Multifunction DC Controller error modes include the following.

- Over-temperature Condition - fast flash
- Over-current Condition - fast flash
- Low-Voltage Disconnect Condition (Load Control Mode) - slow flash

Over-temperature Condition

The temperature of the controller's transistors is continuously monitored. This protects the charge controller from damage in high temperature environments. If excessive temperatures are detected while operating in Charge or Diversion Control mode, the controller's transistors are rapidly turned off and on to reduce the charge rate. This will reduce the transistor temperature.

In Load Control mode, the load is disconnected before the transistors reach an excessive temperature. Once the temperature has dropped, the loads are reconnected.

Over-Current Condition

During operation, the C-Series controller continuously monitors the current flowing through it. If the current exceeds 85 amps, the transistor switches are opened, stopping the flow of electricity. The detection circuitry is faster than breakers or fuses, and they will not trip or blow when a fault occurs.

The C-Series controller automatically resets the over-current protection system every 6 minutes. If an overload or short circuit is still present, the controller will shut off and wait another 6 minutes. This will occur continuously until the problem is corrected.

Fast Blinking Orange

When the over-current or over-temperature protection system has caused the controller to shutdown, the status LED will be orange and will blink fast (about once a second).

Low-voltage Disconnect Condition

If voltage remains below the LVD setting, the unit will disconnect after a 6-minute “delay” (or “grace”) period. To reset and reconnect for another “grace” period (approximately 6 minutes), press and release the reset switch. The user can press the reset switch for a maximum 10-minute “grace” period, or can wait until the voltage rises above the Low Voltage Reconnect (LVR) setting to allow an automatic reset to occur if the EQ/LVR (Auto) jumper is set to “AUTO”.

Slow Blinking Orange

When the disconnect/reconnect system has been activated, the LED will slowly blink orange. The controller is in the DC Load Control mode and has disconnected the loads due to reaching the LVD setting.

Reconnecting to Loads

To reconnect the loads, press the reset button on the right side of the unit. If the voltage is below the LVR level, the DC load can be reconnected for approximately 6 minutes.

A delay up to five seconds may occur before the controller attempts to restart after pressing the reset switch.

Multiple reconnects are allowed, but the “on” time duration will vary with battery voltage. The EQUALIZE jumper allows the controller to be set for AUTO reconnect of the DC load when the voltage exceeds the LVR setting.

Important: The LED will light red only in Load Control mode; never in Charge or Diversion mode (unless it is reversed upon reinstallation).

Reset Switch

Use the Reset Switch on the side of the chassis for the following conditions.

- To manually *initiate battery equalization* in Charge Control mode, press and hold the Reset Switch until the red and green LED start to flash.
- To manually *suspend battery equalization* in Charge Control mode, press and hold the Reset Switch until the red and green LED stop flashing.
- To reset *following an error condition*, press and release the Reset Switch.
- To reset *following a low-voltage disconnect*, press and release the Reset Switch.

See “Reconnecting to Loads” for additional information about reconnecting to loads.

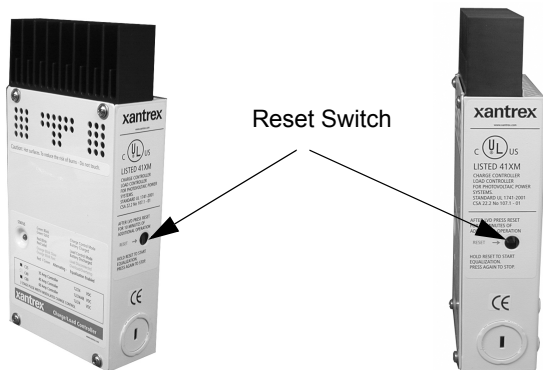

Figure 3-3 Reset Switch

4 Troubleshooting

Chapter 4, “Troubleshooting” contains information about identifying and resolving possible problems with systems using a C-Series Multifunction DC Controller.

For Information on:	See:
“PV Charge Control Troubleshooting”	page 64
“Diversion Control Troubleshooting”	page 66
“Load Control Troubleshooting”	page 68

PV Charge Control Troubleshooting

The following table lists possible problems that may arise when using the C-Series Multifunction DC Controller as a PV Charge Controller.

Table 4-1 PV Charge Control Problems

Problem	Possible Cause	Solution
Controller is overcharging battery (verified by measured current through the controller).	PV positive and Battery positive wires have been swapped.	Verify the voltage on PV terminal and Battery terminal are from the correct sources.
Controller is locking up.	PV positive and Battery positive wires have been swapped.	Verify the voltage on PV terminal and Battery terminal are from the correct sources.
Status LED Blinks Orange after switching on array breaker.	PV wires are connected in reverse polarity.	Verify PV polarity relative to battery negative.
Status LED Blinks Orange at times during the solar day.	A. Controller is overheating. B. Array is supplying more current than the controller is rated for. (Press reset button and measure current).	A. Check ambient air temperature around controller. B. Divide array with another controller or use larger controller.

Table 4-1 PV Charge Control Problems

Problem	Possible Cause	Solution
Current uneven between multiple controllers.	<p>A. Solar arrays are supplying different amounts of current to each charge controller.</p> <p>B. Charging set points are not all set the same.</p> <p>C. Excess voltage drop in wiring causing controllers to measure the battery voltage differently and regulate accordingly.</p> <p>D. Accuracy of the controllers may vary between controllers, due to tolerances in meter design.</p>	<p>A. Check array output.</p> <p>B. Set controllers to the same settings.</p> <p>C. Check wiring.</p> <p>D. Try a different controller if metering is unacceptable.</p>
Status LED blinks red while mode jumper is in “charge control” but still regulates normally.	LED may have been reinstalled backwards.	Remove LED and install correctly. “Flat side” of LED should be on left side.
Battery voltage is exceeding Bulk and Float settings in cold weather and not reaching settings in hot weather.	BTS is compensating charging voltages based on battery temperature.	Nothing - Intended operation. See “Temperature Compensation” on page 33.

Diversion Control Troubleshooting

The following table lists possible problems that may arise when using the C-Series Multifunction DC Controller as a Diversion Controller.

Table 4-2 Diversion Control Problems

Problem	Possible Cause	Solution
Status LED Blinks Orange after switching on diversion load breaker or when diversion begins (Bulk or Float settings reached).	Diversion load draws too much current (above controller rating).	Measure the current the diversion load draws when battery voltage is applied across it. Note: A diversion load with an acceptable “hot” current may have an excessively high inrush current that can cause the controller to overcurrent. Caution: Do not test without a circuit breaker in circuit.
Battery voltage is exceeding Bulk or Float settings.	A. BTS is compensating charging voltages based on battery temperature. B. Diversion load is too small for output of charging source(s).	A. Nothing - Intended operation. See “Temperature Compensation” on page 33. B. Measure the current the diversion load draws when battery voltage is applied across it. Caution: Do not test without a circuit breaker in circuit. A larger diversion load or additional controller each with their own diversion loads may be necessary.

Table 4-2 Diversion Control Problems

Problem	Possible Cause	Solution
Diversion load operates while a generator (fuel powered) is running.	Bulk Voltage setting on diversion controller is set too close to other charger settings.	A. Bulk voltage on controller needs to be set higher than other charging sources or use a switch/relay to disable the diversion load while using a generator.
Diversion load operates immediately at full power when load breaker is turned on.	Mode jumper is set for “Load Control” instead of “Charge Control”.	Change jumper setting.

Load Control Troubleshooting

The following table lists possible problems that may arise when using the C-Series Multifunction DC Controller as a Load Controller.

Table 4-3 Load Control Problems

Problem	Possible Cause	Solution
Load disconnects at different point than set for.	A. Load Control decal is not in place. B. BTS has been installed.	A. Install the decal or follow procedure in manual. See “Setting Voltage Parameters for Load Control Mode” on page 24. B. Battery Temperature Sensors should not be used in load control applications.
Status LED Blinks Orange after switching on the load breaker.	Startup or Inrush current exceeds controller rating.	Use larger controller or “buffer” the controller by using a relay/contacter where the controller operates only the coil of the relay/contacter and not directly to the DC load.

A Specifications

Appendix A, “Specifications” provide the specifications for the C-Series Multifunction DC Controller.

For information on:	See:
“Electrical Specifications”	page 70
“Features and Options Specifications”	page 71
“Environmental Specifications”	page 72

Electrical Specifications

The following lists the electrical specifications for the C-Series controllers Models C35, C40, and C60.

Table A-1 Electrical Specifications

Model	C35		C40			C60	
Voltage Configuration	12 Vdc	24 Vdc	12 Vdc	24 Vdc	48 Vdc	12 Vdc	24 Vdc
Maximum PV Array Open Circuit Voltage	55 Vdc	55 Vdc	125 Vdc	125 Vdc	125 Vdc	55 Vdc	55 Vdc
Charging Load Current	35 amps DC continuous		40 amps DC continuous			60 amps DC continuous	
Recommended Breaker Size with recommended Wire Size in Conduit	60 amps DC #6 AWG		60 amps DC #6 AWG			60 amps DC (100% continuous duty cycle), #6 AWG (90 ° C rated)	
Maximum Short Circuit Current	85 amps intermittently		85 amps intermittently			85 amps intermittently	
Maximum Voltage Drop	0.30 volts - charge control mode						
Total Current Consumption	While operating - 15 mA (typical), at idle - 3 mA (tare)						
Charger Regulation Method	Solid state, 3-stage (bulk, absorption and float) Pulse Width Modulation (PWM)						
Charging Control Settings:							
Lead Acid Battery	12 Volt System: Float 12.5 - 14.5 Vdc Bulk 13.0 - 15.0 Vdc EQ = +1 above Bulk		24 Volt System: Float 25.0 - 29.0 Vdc Bulk 26.0 - 30.0 Vdc EQ = +2 above Bulk			48 Volt System: Float 50.0 - 58.0 Vdc Bulk 52.0 - 60.0 Vdc EQ = +4 above Bulk	
NiCad battery	12 Volt System: Float 14.5 - 16.5 Vdc Bulk 15.0 - 17.0 Vdc EQ = not recommended		24 Volt System: Float 29.0 - 33.0 Vdc Bulk 30.0 - 34.0 Vdc EQ = not recommended			48 Volt System: Float 58.0 - 66.0 Vdc Bulk 60.0 - 68.0 Vdc EQ = not recommended	

Table A-1 Electrical Specifications

Model	C35	C40	C60
Load Control Settings:			
System Voltage:	12 Volt System:	24 Volt System:	48 Volt System:
Low Voltage Reconnect	LVR 12.0 to 14.0 Vdc	LVR 24.0 to 28.0 Vdc	LVR 48.0 to 56.0 Vdc
Low Voltage Disconnect	LVD 10.5 to 12.5 Vdc	LVD 21.0 to 25.0 Vdc	LVD 42.0 to 50.0 Vdc

Features and Options Specifications

The following lists the features and options specifications for the C-Series controllers Models C35, C40, and C60.

Table A-2 Features and Options Specifications

Model	C35	C40	C60
Standard Features			
Status Indicator	Multi color LED indicates the operating/battery voltage status.		
Low Voltage Disconnect Load Control Mode	User selectable manual or automatic reconnection - includes warning flash before disconnect and 6 minutes “grace” period.		
Equalization Charge Charge Control Mode	User selectable manual or automatic equalization (every 30 days).		
Short Circuit Protection	Fully electronically protected with auto-reset.		
Adjustable Control Setpoints (test points provided for high accuracy)	Two user-adjustable, voltage setpoints for control of loads or charging sources (settings retained if battery is disconnected.)		
Options			
LCD Meter Panel (CM, CM/R-50, CM/R-100)	Back-lit, 32-character, alpha-numeric liquid crystal display panel for remote (CM/R) or front mounting (CM) on the C-Series controller.		
External Battery Temperature Sensor (BTS/15, BTS/35)	Provides automatic adjustment of the charge control set point to the battery temperature (may be extended)		

Environmental Specifications

The following lists the environmental specifications for the C-Series controllers Models C35, C40, and C60.

Table A-3 Environmental Specifications

Model	C35	C40	C60
Enclosure Type	Indoor, ventilated, powder-coated steel with 3/4" and 1" knockouts.		
Operating Temperature Range	32 to 104 °F (0 to +40 °C) Specifications at 25°C		
Non-operating Temperature	-67 to 284 °F (-55 to +75 °C) Specifications at 25°C		
Altitude Limit (operating)	15,000 feet (5,000 meters)		
Altitude Limit (non-operating)	50,000 feet (16,000meters)		
Dimensions (H x W x D)	8" x 5" x 2.5" (20.3 cm x 12.7 cm x 6.35 cm)	10" x 5" x 2.5" (25.4 cm x 1.7 cm x 6.35 cm)	
Mounting	Vertical Wall Mount		
Weight (Controller only)	2.5 lbs (1.2 kg)	3.0 lbs (1.4 kg)	3.0 lbs (1.4 kg)
Weight (Shipping)	3.0 lbs (1.4 kg)	3.5 lbs (1.6 g)	3.5 lbs (1.6 kg)

*Specifications at 25°C

Specifications subject to change without notice

B Batteries

Appendix B, “Batteries” describes types of batteries.

For information on:	See:
“Battery Types”	page 74
“Battery Sizing”	page 76
“Equalization Charging”	page 77

Battery Types

Batteries come in different sizes, types, amp-hour capacity, voltages and chemistries. Here are a few guidelines that will help in battery selection, and ensure that the batteries are properly maintained. The best source of the most appropriate settings for the C-Series will be from the manufacturer or supplier of the batteries.



WARNING: Explosion/Corrosion Hazard

Batteries can vent hydrogen-sulfide gas, which is corrosive to electronic equipment. Batteries also generate hydrogen and oxygen gas that can explode when exposed to a spark. Be sure to read the safety precautions on page viii regarding batteries.

Automotive Batteries

Automotive and truck batteries are designed for high cranking power – not deep-cycling. Do not use them unless no other battery type is available. They simply will not last long in a cycling application.

Maintenance-Free Batteries

This type of battery is often sold as a RV or marine battery, but is rarely appropriate for use with a PV system. They typically have an additional reserve of electrolyte, but are vented. This is not the same as a sealed battery.

Deep-Cycle Batteries

Best suited for use with PV systems, this type of battery is designed to be more deeply discharged before being recharged. Deep-cycle batteries are available in many sizes and types. The most common is the vented liquid electrolyte battery.

Vented batteries usually have battery caps. The caps may appear to be sealed, but are not. The caps should be removed periodically to check the level of electrolyte. When a cell is low, distilled water should be added after the battery is fully charged. If the level is extremely low, add only enough distilled water to cover the plates before recharging. The electrolyte volume increases during the charging process and the battery will overflow if it is filled all of the way up before recharging. Use only distilled water because impurities will reduce battery performance.

A popular and inexpensive deep-cycle battery is the “golf cart” battery. It is a 6-volt design, typically rated at 220 amp hours. RV and marine deep-cycle batteries are also popular for small systems. They are usually referred to as Group 24 or Group 27 batteries and are rated at 80 to 100 amp-hours at 12 volts. Many larger systems use L16 batteries, which are usually rated at 350 amp-hours at 6-volts each. They are 17 inches high and weigh about 130 pounds. 8D batteries are available with either cranking or deep-cycle construction. Purchase only the deep-cycle version. The 8D is typically rated at 220 amp hours at 12 volts.

Sealed Batteries

Another type of battery construction is the sealed gel cell. They do not use battery caps. The electrolyte is in the form of a gel rather than a liquid, which allows the batteries to be mounted in any position. The advantages are no maintenance, long life (800 cycles claimed) and low self-discharge. Absorbed glass mat (AGM) electrolyte batteries are also acceptable. Their electrolyte is contained in mats between the battery plates.

Sealed batteries reduce the maintenance requirements for the system and are good for remote applications. They are much more sensitive to the charging process and can be ruined in as little as a day of overcharging.

NiCad and NiFe Batteries

The Xantrex C-Series is compatible with NiCad (nickel-cadmium) NiFe (nickel-iron) and alkaline-type batteries, which must be charged to a higher voltage level to achieve a full charge.

To use the C-Series with NiCad batteries, clip the wire on the resistor labeled “R46” in the middle of the C-Series circuit board by cutting it. See “Setting Voltage Parameters for Alkaline Batteries” on page 26 for instructions on how to clip this wire.

Avoid damage to neighboring components.

Important: In all applications the BULK voltage setting should be adjusted to a level below the maximum operating voltage of the DC loads. This may be as low as 15 volts for some types of electronic loads. Undercharging may occur in this instance, but DC equipment will be protected. Check with the manufacturers of the DC equipment being powered for its maximum DC input voltage tolerance. If equalization is expected to occur, then the DC equipment being used must tolerate the voltages which will occur during the equalization process.

Battery Sizing

Batteries are the fuel tank of the system. The larger the batteries, the longer the system can operate before recharging is necessary. An undersized battery bank results in short battery life and disappointing system performance.

To determine the proper battery bank size, compute the number of amp-hours that will be used between charging cycles. Once the required amp hours are known, size the batteries at approximately twice this amount. Doubling the expected amp-hour usage ensures that the batteries will not be overly discharged and will extend battery life.

Equalization Charging

Approximately every month, some batteries may need to be “equalized.” Since the individual cells of the battery are not identical, some cells may not be fully charged when the charging process is completed. If the batteries have been left in a discharged condition for long periods of time, the plates will have sulfates on them from the electrolyte. If the sulfate remains on the plates for an extended period of time, it will harden and seal off a percentage of the plate area, reducing the capacity of the battery. By equalizing the batteries before the sulfate hardens, the sulfate is removed from the plates.

Batteries with liquid electrolyte may become stratified. Stratification concentrates the sulfuric acid into the bottom of the cell while the top becomes diluted. This corrodes the lower portion of the plates, reducing battery life. Mixing of the electrolyte by the formation of gas bubbles during the equalization process reduces stratification.

Two methods can be used to determine if a battery needs to be equalized. If possible, measure the voltage of each individual cell while the battery is at rest (not being charged or discharged). A variation of 0.05 volts between cells indicates an imbalance exists. If the battery construction prevents measurement of the individual cell voltages, use a hydrometer. A variation of 0.020 in the specific gravity between cells is considered significant. Both conditions can be corrected by an equalization charge.

A proper equalization charge will not damage a vented, liquid electrolyte type battery. It may, however, cause significant electrolyte usage and require that the battery be refilled with distilled water to the correct level. This may be a problem with unattended systems in remote areas which do not receive regular maintenance. Consult the battery manufacturer for their recommendations.



CAUTION: Damage to Batteries

Equalization should be done only on vented (not sealed or maintenance-free) lead-acid, liquid-electrolyte batteries. The battery manufacturer should be consulted before attempting to equalize any other battery type. Add clean, distilled water to the battery following the equalization process.



CAUTION: Damage to Loads

DC loads may need to be disconnected by turning off circuit breakers or removing fuses before equalization to prevent damage by the required higher voltages used in the equalization process.



CAUTION

If the batteries are equipped with hydro caps (catalytic gas recombiner caps), they should be removed during the equalization process. If hydro caps are used, you should disable automatic equalization to prevent possible damage.

Equalization Setpoints (Non-Sealed Batteries Only)

Table B-1 Typical Bulk and Float Setpoints for Batteries

Battery Type	Bulk Volts	Float Volts	Equalizing Charge
Default Settings (knobs at nine o'clock position)	14.0 Vdc	13.5 Vdc	Disabled (manual jumper)
Sealed Gel Lead Acid Battery	14.1 Vdc	13.6 Vdc	Non recommended. Consult Battery manufacturer.
AGM Lead Acid Battery	14.4 Vdc	13.4 Vdc	Charge to 15.5 Vdc or per manufacturer.
Maintenance-Free RV/Marine	14.4 Vdc	13.4 Vdc	Limited appropriateness - if water level can be checked.
Deep-Cycle, Liquid Electrolyte Lead Antimony Battery	14.6 Vdc	13.4 Vdc	Charge to 15.5 Vdc or per battery manufacturer.
NiCad or NiFe Alkaline Battery ^a	16.0 Vdc	14.5 Vdc	Not recommended. Consult battery manufacturer.

Values shown are for 12-volt systems. For 24-volt Systems, multiply this setting shown by 2. For 48-volt systems, multiply the settings shown by 4.

Important: The following settings (Table B-1) are guidelines only. Refer to your battery vendor for specific settings and battery maintenance guidelines.

a. For NiCad and NiFe batteries, you must clip the R46 resistor and add 2 volts to the values for BULK AND FLOAT shown on the circuit board. For example, set the BULK for 16.0 V adjust the BULK knob to 14.0 V after clipping R46. Values above are for batteries at room temperature. For applications with significant temperature variations or systems with sealed batteries, install a battery temperature sensor.

C Diversion Loads

Appendix C, “Diversion Loads” provides additional information about Diversion Loads.

For information on:

“Diversion Load Types”

See:

page 82

Diversion Load Types

Several different types of diversion loads are available to the alternative energy market. These loads are designed to operate with the power output levels common to most diversion load controllers. The following are several available diversion loads which may be used successfully for heating water or air.

A 120 Vac, 2000-watt water heater element, available at most hardware stores, may be used with a 12-, 24-, or 48-volt DC system; however do not expect a 2000-watt power dissipation. The power draw is determined by the heater element's DC resistance, the output voltage of the controller, as well as the output current capability of the charging source(s).

These heater elements were designed to operate at 120 volts AC. A 48-volt, 40-amp charge controller will operate just fine with this type of a system providing about 500 watts of power dissipation.

A 12- or 24-volt diversion load controller will work but doesn't put out enough power to effectively heat water with only one element. The remedy to this type of problem is to parallel several of these heater elements to increase the power output.

Table C-1 below shows power dissipation of a 120 Vac, 2000-watt heater element operated at different voltages. Note that the voltages given are roughly the bulk charge stage voltages for a given system.

Table C-1 Power Dissipation

System Voltage	Power	Amperage
60 Vdc (48 Vdc system)	500 W	8.3 amps
30 Vdc (24 Vdc system)	125 W	4.2 amps
15 Vdc (12 Vdc system)	31 W	2.1 amps
120 Vac	2000 W	16.7 amps

Regardless of the type of diversion load you decide to utilize, make sure that the diversion load can handle all the power the charging system is capable of putting out. Paralleling heater elements (whether open air or water heater) will allow more power dissipation.

A good rule of thumb is to not have a combined charging source greater than 80% of the diversion load controller's current handling ability.

For example, if a Xantrex C-Series, 40-amp diversion load controller is being used, do not place a combination of charging sources which are capable of putting out more than 32 amps (80% of 40 amps) on the load controller's circuit.

Sizing a diversion system this way allows a safety margin for unusual conditions (high winds, high water flow, etc.).

It is not recommended that light bulbs be used as diversion loads for a couple of reasons:

1. An incandescent light bulb has a substantially lower cold filament resistance than when it is on. This means it draws more power (up to five times) to start the light when it is cold than once the filament has warmed up. Even a 40-watt light bulb may have an in-rush amperage at turn-on of 200 amps. This could cause the load controller to shut down.
2. In the event a light bulb load burns out, a smaller-than-necessary load will be present, and the excess energy will have nowhere to go.

Warranty and Product Information

Warranty

What does this warranty cover? This Limited Warranty is provided by Xantrex Technology, Inc. ("Xantrex") and covers defects in workmanship and materials in your C-Series Multifunction DC Controller. This warranty period lasts for two years from the date of purchase at the point of sale to you, the original end user customer. You require proof of purchase to make warranty claims.

This Limited Warranty is transferable to subsequent owners but only for the unexpired portion of the Warranty Period. Subsequent owners also require proof of purchase.

What will Xantrex do? Xantrex will, at its option, repair or replace the defective product free of charge, provided that you notify Xantrex of the product defect within the Warranty Period, and provided that Xantrex through inspection establishes the existence of such a defect and that it is covered by this Limited Warranty.

Xantrex will, at its option, use new and/or reconditioned parts in performing warranty repair and building replacement products. Xantrex reserves the right to use parts or products of original or improved design in the repair or replacement. If Xantrex repairs or replaces a product, its warranty continues for the remaining portion of the original Warranty Period or 90 days from the date of the return shipment to the customer, whichever is greater. All replaced products and all parts removed from repaired products become the property of Xantrex.

Xantrex covers both parts and labor necessary to repair the product, and return shipment to the customer via a Xantrex-selected non-expedited surface freight within the contiguous United States and Canada. Alaska and Hawaii are excluded. Contact Xantrex Customer Service for details on freight policy for return shipments outside of the contiguous United States and Canada.

How do you get service? If your product requires troubleshooting or warranty service, contact your merchant. If you are unable to contact your merchant, or the merchant is unable to provide service, contact Xantrex directly at:

Telephone: 1 800 670 0707 (toll free North America)

1 360 925 5097 (direct)

Fax: 1 800 994 7828 (toll free North America)

1 360 925 5143 (direct)

Email: customerservice@xantrex.com

Warranty and Product Information

Direct returns may be performed according to the Xantrex Return Material Authorization Policy described in your product manual. For some products, Xantrex maintains a network of regional Authorized Service Centers. Call Xantrex or check our website to see if your product can be repaired at one of these facilities.

What proof of purchase is required? In any warranty claim, dated proof of purchase must accompany the product and the product must not have been disassembled or modified without prior written authorization by Xantrex.

Proof of purchase may be in any one of the following forms:

- The dated purchase receipt from the original purchase of the product at point of sale to the end user, or
- The dated dealer invoice or purchase receipt showing original equipment manufacturer (OEM) status, or
- The dated invoice or purchase receipt showing the product exchanged under warranty

What does this warranty not cover? This Limited Warranty does not cover normal wear and tear of the product or costs related to the removal, installation, or troubleshooting of the customer's electrical systems. This warranty does not apply to and Xantrex will not be responsible for any defect in or damage to:

- a) the product if it has been misused, neglected, improperly installed, physically damaged or altered, either internally or externally, or damaged from improper use or use in an unsuitable environment;
- b) the product if it has been subjected to fire, water, generalized corrosion, biological infestations, or input voltage that creates operating conditions beyond the maximum or minimum limits listed in the Xantrex product specifications including high input voltage from generators and lightning strikes;
- c) the product if repairs have been done to it other than by Xantrex or its authorized service centers (hereafter "ASCs");
- d) the product if it is used as a component part of a product expressly warranted by another manufacturer;
- e) the product if its original identification (trade-mark, serial number) markings have been defaced, altered, or removed.

Disclaimer

Product

THIS LIMITED WARRANTY IS THE SOLE AND EXCLUSIVE WARRANTY PROVIDED BY XANTREX IN CONNECTION WITH YOUR XANTREX PRODUCT AND IS, WHERE PERMITTED BY LAW, IN LIEU OF ALL OTHER WARRANTIES, CONDITIONS, GUARANTEES, REPRESENTATIONS, OBLIGATIONS AND LIABILITIES, EXPRESS OR IMPLIED, STATUTORY OR OTHERWISE IN CONNECTION WITH THE PRODUCT, HOWEVER ARISING (WHETHER BY CONTRACT, TORT, NEGLIGENCE, PRINCIPLES OF MANUFACTURER'S LIABILITY, OPERATION OF LAW, CONDUCT, STATEMENT OR OTHERWISE), INCLUDING WITHOUT RESTRICTION ANY IMPLIED WARRANTY OR CONDITION OF QUALITY, MERCHANTABILITY OR FITNESS FOR A PARTICULAR PURPOSE. ANY IMPLIED WARRANTY OF MERCHANTABILITY OR FITNESS FOR A

PARTICULAR PURPOSE TO THE EXTENT REQUIRED UNDER APPLICABLE LAW TO APPLY TO THE PRODUCT SHALL BE LIMITED IN DURATION TO THE PERIOD STIPULATED UNDER THIS LIMITED WARRANTY.

IN NO EVENT WILL XANTREX BE LIABLE FOR ANY SPECIAL, DIRECT, INDIRECT, INCIDENTAL OR CONSEQUENTIAL DAMAGES, LOSSES, COSTS OR EXPENSES HOWEVER ARISING WHETHER IN CONTRACT OR TORT INCLUDING WITHOUT RESTRICTION ANY ECONOMIC LOSSES OF ANY KIND, ANY LOSS OR DAMAGE TO PROPERTY, ANY PERSONAL INJURY, ANY DAMAGE OR INJURY ARISING FROM OR AS A RESULT OF MISUSE OR ABUSE, OR THE INCORRECT INSTALLATION, INTEGRATION OR OPERATION OF THE PRODUCT.

Exclusions

If this product is a consumer product, federal law does not allow an exclusion of implied warranties. To the extent you are entitled to implied warranties under federal law, to the extent permitted by applicable law they are limited to the duration of this Limited Warranty. Some states and provinces do not allow limitations or exclusions on implied warranties or on the duration of an implied warranty or on the limitation or exclusion of incidental or consequential damages, so the above limitation(s) or exclusion(s) may not apply to you. This Limited Warranty gives you specific legal rights. You may have other rights which may vary from state to state or province to province.

Warning: Limitations On Use

Please refer to your product manual for limitations on uses of the product.

SPECIFICALLY, PLEASE NOTE THAT THE C-SERIES MULTIFUNCTION DC CONTROLLER SHOULD NOT BE USED IN CONNECTION WITH LIFE SUPPORT SYSTEMS OR OTHER MEDICAL EQUIPMENT OR DEVICES. WITHOUT LIMITING THE GENERALITY OF THE FOREGOING, XANTREX MAKES NO REPRESENTATIONS OR WARRANTIES REGARDING THE USE OF THE XANTREX C-SERIES MULTIFUNCTION DC CONTROLLER IN CONNECTION WITH LIFE SUPPORT SYSTEMS OR OTHER MEDICAL EQUIPMENT OR DEVICES.

Return Material Authorization Policy

Before returning a product directly to Xantrex you must obtain a Return Material Authorization (RMA) number and the correct factory "Ship To" address. Products must also be shipped prepaid. Product shipments will be refused and returned at your expense if they are unauthorized, returned without an RMA number clearly marked on the outside of the shipping box, if they are shipped collect, or if they are shipped to the wrong location.

When you contact Xantrex to obtain service, please have your instruction manual ready for reference and be prepared to supply:

- The serial number of your product
- Information about the installation and use of the unit
- Information about the failure and/or reason for the return
- A copy of your dated proof of purchase

Record these details in "Information About Your System" on page 89.

Return Procedure

1. Package the unit safely, preferably using the original box and packing materials. Please ensure that your product is shipped fully insured in the original packaging or equivalent. This warranty will not apply where the product is damaged due to improper packaging.
2. Include the following:
 - The RMA number supplied by Xantrex Technology, Inc. clearly marked on the outside of the box.
 - A return address where the unit can be shipped. Post office boxes are not acceptable.
 - A contact telephone number where you can be reached during work hours.
 - A brief description of the problem.
3. Ship the unit prepaid to the address provided by your Xantrex customer service representative.

If you are returning a product from outside of the USA or Canada In addition to the above, you **MUST** include return freight funds and are fully responsible for all documents, duties, tariffs, and deposits.

If you are returning a product to a Xantrex Authorized Service Center (ASC) A Xantrex return material authorization (RMA) number is not required. However, you must contact the ASC prior to returning the product or presenting the unit to verify any return procedures that may apply to that particular facility.

Out of Warranty Service

If the warranty period for your C-Series Multifunction DC Controller has expired, if the unit was damaged by misuse or incorrect installation, if other conditions of the warranty have not been met, or if no dated proof of purchase is available, your inverter may be serviced or replaced for a flat fee.

To return your C-Series Multifunction DC Controller for out of warranty service, contact Xantrex Customer Service for a Return Material Authorization (RMA) number and follow the other steps outlined in “Return Procedure” on page 88.

Payment options such as credit card or money order will be explained by the Customer Service Representative. In cases where the minimum flat fee does not apply, as with incomplete units or units with excessive damage, an additional fee will be charged. If applicable, you will be contacted by Customer Service once your unit has been received.

Information About Your System

As soon as you open your C-Series Multifunction DC Controller package, record the following information and be sure to keep your proof of purchase.

- Serial Number (on DC end) _____
- Purchased From _____
- Purchase Date _____

If you need to contact Customer Service, please record the following details before calling. This information will help our representatives give you better service.

- Type of installation [e.g. _____
RV, truck, vehicle, home]
- Length of time inverter has _____
been installed
- Battery/battery bank size _____
- DC wiring size and length _____
- Warning, Error or Panel _____
Fault Message
- Appliances operating when _____
problem occurred
- Description of problem _____

Index

A

Accessories 12
Automatic Equalization 32

B

Battery Safety Information viii
Battery Temperature Compensation 6
Battery Temperature Sensor 12, 51
BULK charge voltage 22

C

Charge Control or Diversion Control
Mode Indications 59
Customer Service
preparing to call 89

D

Diversion Control Mode 8, 26

E

EQ/LVR Jumper 21
Equalization Charging 30
Equalization Mode Indication 57
Error Mode Indication 59

F

FLOAT charge voltage 23

G

Grounding 37

I

Information about Your System form
89

J

Jumper Settings 18

K

Knockouts 14

L

LED Status Indicator 55
Load Control Indications 57
Low Voltage Disconnect 25
Low Voltage Reconnect 24

M

Manual Equalization 31

N

National Electrical Code 3

O

Operating Mode Jumper 20
Over-Current 59
Over-Temperature 59

P

Photovoltaic Charge Control Mode 7
proof of purchase 89
Pulse Width Modulated 2
purchase date 89

R

Reset Switch 59

S

Safety Instructions vii
serial number 89

T

Test Points for Voltage Settings 28
Torque Requirements 39
Troubleshooting 64

V

Voltage Jumper 20

W

warranty
 out of warranty service 88
 terms and conditions 85
Wire Size 39
Wiring 38

X

Xantrex
 web site v

Xantrex Technology Inc.

1 800 670 0707 Tel toll free NA
1 360 925 5097 Tel direct

1 800 994 7828 Fax toll free NA
1 360 925 5143 Fax direct

customerservice@xantrex.com

www.xantrex.com