

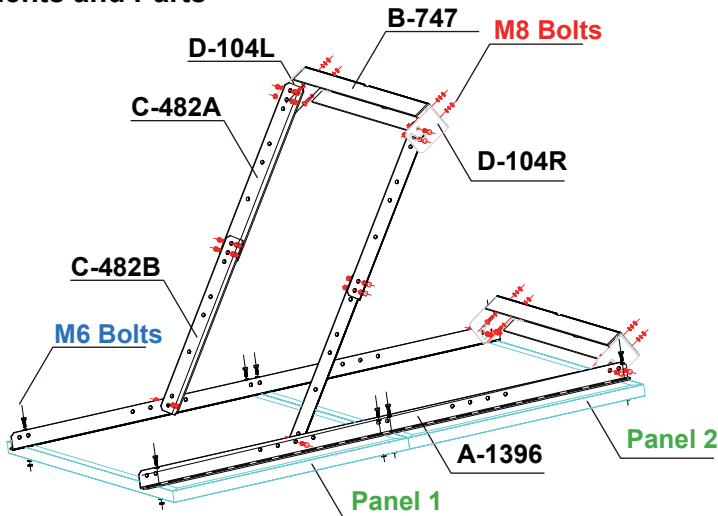

Thank you for purchasing SOLARLAND products. SLB-0124 mounting kits are designed to mount two panels with bottom support for better structure stability.(see in chart for size fitting)

## Components and Parts

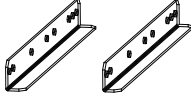
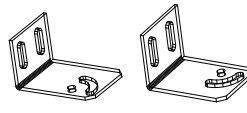
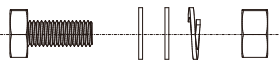

## Part

			
<b>A-1396</b>		<b>B-747</b>	
Component	Fixed Bracket	Component	Fixed Bracket
Material	Aluminum Alloy	Material	Aluminum Alloy
Size	55×1.97×1.1in	Size	29.4×3.3×1.9in
Quantity	2	Quantity	2
			
<b>C-482A/B</b>		<b>D-104L/R</b>	
Component	Fixed Bracket	Component	Tilt Arm
Material	Aluminum Alloy	Material	Aluminum Alloy
Size	19×1.7×1.1/19×1.6×1in	Size	4.1×3×2.5in
Quantity	2/2	Quantity	2/2
		<b>Fit Model:</b>	
<b>M6/M8</b>		SLP U Series panels (50W to 180W)	
Component	Tilt Arm	SLP C1D2 Series panels (45W to 150W)	
Material	Stainless Steel	SLP CSA Series panels (50W to 60W)	
Size	M6:6×18mm M8:8×20mm		
Quantity	8/22		

\*(M6) all 8 mounting bolts will be used to install A-1396(fixed bracket) to the PV module frame. Place 1 mounting bolt on each corner of the PV module frame.

\*(M8) mounting bolts-all 22 will be used to install the entire mounting bracket. Parts A-1396,B-747,C-482A/B and D-104L/R will require the use of M8 mounting bolt.

**Caution:** If additional holes on the frame of the PV Module are needed, great care must be taken when drilling. Otherwise, damage to the module can easily occur rendering it useless. You may find it helpful to lubricate the nut and bolt to facilitate an easy removal at a later date.

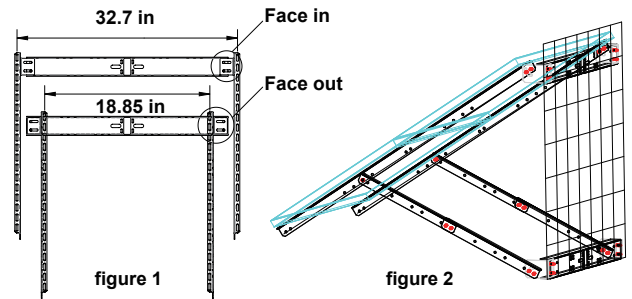

**Step 1.** Assemble fixed bracket (A-1396) and align with the designated holes along the PV module frame. Use mounting bolts (M6) to install onto the PV module frame. Screw one mounting bolt on each corner of the PV module frame. Gather fixed bracket (B-747) along tilt arm (D-104L/R) designated for left and right and align holes for installation onto the fixed bracket. The fixed bracket (B-747) will serve as the top portion of mounting kit. Use four mounting bolts (M8) to screw into the tilt arm (D-104L/R) and attach both fixed brackets together (A-1396) (B-747). Once done, the top portion of mounting bracket is completed.

**Please note:** Tilt arm (D-104L/R) with arc holes can be adjusted according to the mounting holes on the fixed bracket. The tilt arm can be placed face in or out to maximize the distance for the PV Module as desired. See figure 1 for illustration.

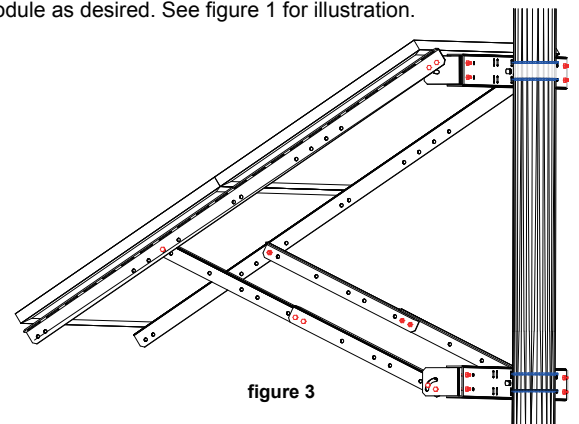

**Step 2.** Gather fixed bracket (C-482A/B) and align with designated holes along the frame of the PV module for the desired tilt angle. Install 2 mounting bolts in the middle of each side to combine fixed brackets (C-482A/B). See the illustration on the left for reference. Then install one mounting bolt on each side to connect to the PV module frame. Lastly, install the fixed bracket (B-747) along with tilt arm (D-104L/R) to fixed bracket (C-482A/B). Once done, the bottom portion of mounting kit will be completed.

To adjust the tilt angle of the PV panel, change the location of mounting bolts in the arc holes of tilt arm. Remember to use lock washers to prevent vibration from working them loose.

**Step 3.** See figure 2 for wall, use at least 8 fastening points with wood screw, sheet metals, anchors or molly bolts (not included in kit).

Use steel clamps or U bolts (purchase separately) on pole mounting (figure 3). For better strength and stability, U-bolts are required for panels with a total weight of 40lbs or more.

**Step 4.** Be sure to seal all roof or wall penetrations with a compatible weatherproof sealant.