



**Sol-Ark<sup>®</sup> 5K OUTDOOR**  
 LIMITLESS POWER  
**OUTDOOR SOL-ARK 5K INSTALL GUIDE & OWNER'S MANUAL**

**UPON RECEIVING SHIPMENT .....4**

**SPEC SHEET.....5**

**WIRE GAUGE GUIDE (COPPER) .....7**

**WIRING DIAGRAMS .....8**

**GUI SCREENS .....12**

**PHYSICAL INSTALLATION .....14**

    INVERTER COMPONENTS .....14

    DECIDING BACKUP CIRCUITS .....14

    SINGLE SYSTEM INSTALLS .....15

    MOUNTING THE SOL-ARK .....15

    INTEGRATING BATTERIES (SOL-ARK POWERED "OFF") .....15

    E.M.P SYSTEMS ONLY .....16

    CONNECTING SOLAR PANELS .....16

    INTEGRATING A GENERATOR .....17

    INTEGRATING SENSORS AND ACCESSORY PLACEMENT .....18

    POWERING-UP AND TESTING THE SOL-ARK 5K .....20

    CHECK THE VOLTAGE ON EACH PV INPUT CIRCUIT .....20

**WI-FI / INTERNET CONNECTION .....21**

    REMOTE MONITORING SETUP .....21

    IP ADDRESS SETUP INSTRUCTIONS (PC OR SMART PHONE).....24

**PROGRAMMING GUIDE .....26**

    MAIN SCREENS (TOUCHSCREEN) .....27

    BASIC SETUP.....28

    SYSTEM ALARMS .....28

    BATTERY SETUP.....29

    GRID SETUP.....31

    LIMITER SENSOR AUTOMATIC SETUP .....34

**INSTALL TIPS.....35**

    OFF-GRID INSTALL TIPS .....35

    GRID-TIE / NO BATTERY INSTALL TIPS .....35

**BATTERIES.....36**

    BATTERY CHARGING INFORMATION.....36

    MODBUS/RJ45 APPLICATION NOTE .....38

**TROUBLESHOOTING GUIDE .....39**

    TROUBLESHOOTING PHASING ISSUES.....40

    SOL-ARK 8K ERROR CODES .....41

**INSTALL VERIFICATION CHECKLIST.....42**

**SOL-ARK 5K LIMITED WARRANTY .....43**



## Disclaimer

UNLESS SPECIFICALLY AGREED TO IN WRITING, SOL-ARK:

(a) MAKES NO WARRANTY REGARDING THE ACCURACY, SUFFICIENCY, OR SUITABILITY OF ANY TECHNICAL OR OTHER INFORMATION PROVIDED IN ITS MANUALS OR OTHER DOCUMENTATION.

(b) ASSUMES NO RESPONSIBILITY OR LIABILITY FOR LOSS OR DAMAGE, WHETHER DIRECT, INDIRECT, CONSEQUENTIAL, OR INCIDENTAL, WHICH MIGHT ARISE OUT OF THE USE OF SUCH INFORMATION. THE USE OF ANY SUCH INFORMATION WILL BE ENTIRELY AT THE USER'S RISK.

Sol-Ark cannot be responsible for system failure, damages, or injury resulting from improper installation of their products.



The information included in this manual is subject to change without notice.

This version is for **OUTDOOR MODELS ONLY**; previous hardware versions of the Sol-Ark 5K are not compatible with the wire diagrams and instructions contained herein.











### Contact Us:

PHONE	1-972-575-8875 x2
EMAIL	<a href="mailto:SUPPORT@SOL-ARK.COM">SUPPORT@SOL-ARK.COM</a>
WEBSITE	<a href="http://WWW.SOL-ARK.COM">WWW.SOL-ARK.COM</a>

## Warning Symbols

	This symbol indicates information that, if ignored, could result in minor injury or damage to the equipment.
	This symbol indicates information that, if ignored, could result in serious injury, damage to the equipment, or death.
	This symbol indicates information that is important but not hazard-related.

## Warnings

-  Read this entire document before installing or using the Sol-Ark 5K inverter. Failure to follow any of the instructions or warnings in this document can result in electrical shock, serious injury, or death. Damage to the 5K inverter is also possible, potentially rendering it inoperable.
-  High Life Risk Due to Fire or Electrocution – ONLY qualified persons should install the Sol-Ark 5K inverter.
-  The system must have Ground connections and Neutral connections. Ground MUST be bonded to Neutral ONLY ONCE in the circuit.
-  Solar PV+/PV- are UNGROUNDED. Note, you may ground PV Racking/Mounts, but doing so directly to the Sol-Ark will likely result in damage in the case of a direct lightning strike to the PV array.
-  DO NOT connect the grid to the Load Output Breaker.
-  DO NOT reverse the polarity of batteries. Damage WILL occur.
-  DO NOT exceed more than 500Voc on any MPPT on the Sol-Ark.
-  DO NOT use impact drivers to tighten any fasteners on the Sol-Ark.
-  MUST use Strain Reliefs ON ALL wires entering/exiting the Sol-Ark 5K user area.
-  MUST use conduit (or double insulated wire) for AC Wires entering/exiting Sol-Ark 5K user area.
-  ALL terminals/breakers including battery, MPPT, and AC breaker inputs should only have one conductor connecting to them.

## Inspect Shipment

- A. Compare the package condition to the condition of the package in the photo we sent you before it left our facility.



**You must note any damage due to shipping with delivery driver before accepting the package otherwise the shipping company will deny any claim.**

- B. If damaged, contact us immediately at 972-575-8875 Ext. 3

### Component Guide

- A. Limiter Sensors included: 5/8" CT sensors x2 (**Included**)
- B. Limiter Sensors if purchased: 15/16" CT sensors x2 (**Sold Separately**)
- C. Limiter Sensors if purchased: 2" CT sensors x2 (**Sold Separately**)
- D. Battery Temperature Sensor: for voltage adjustment
- E. Battery Cable Toroid x2
- F. CAT 5 cable for parallel communications
- G. French Cleat: For wall mounting the Sol-Ark 5K
- H. WIFI Dongle: For software updates and remote monitoring (use M4x10 screws to hold in)

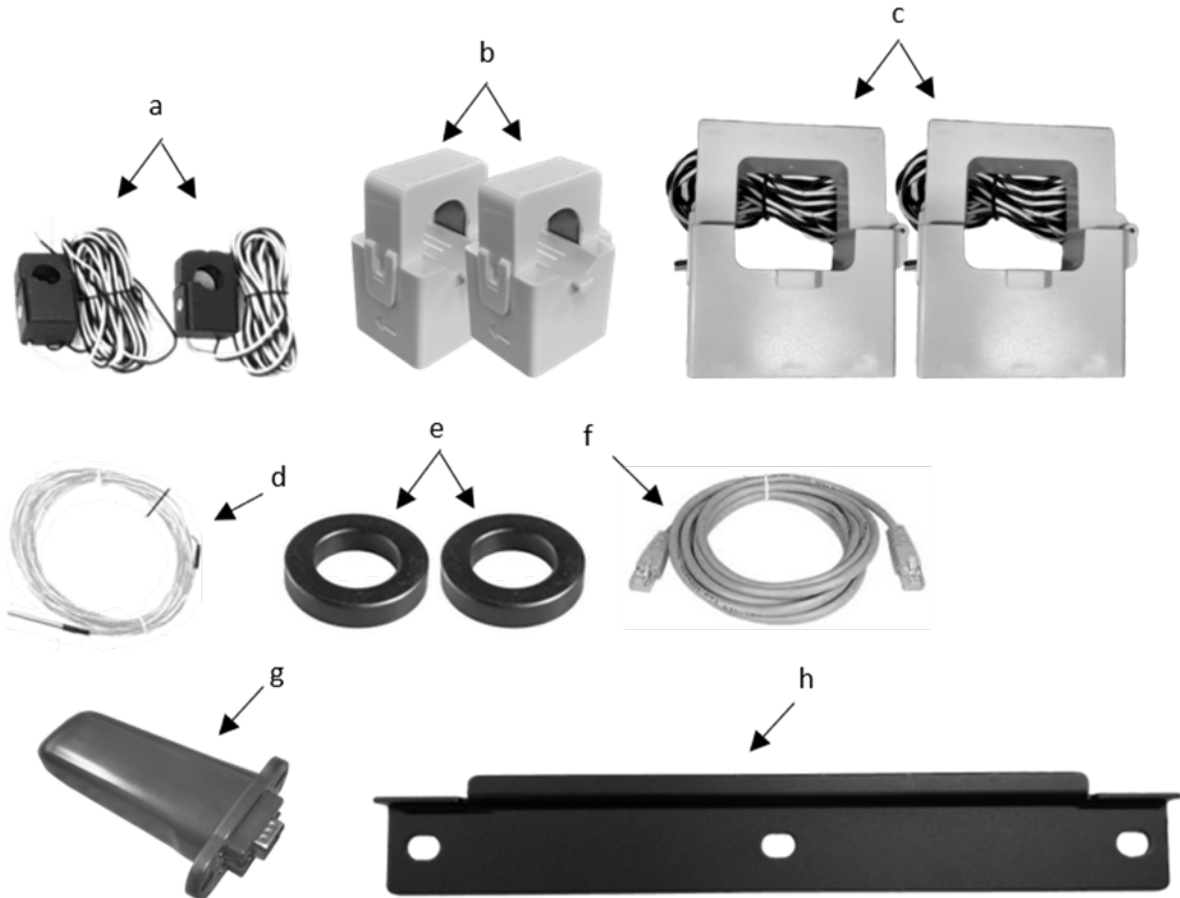



# Sol-Ark

## 5K-P

### Spec Sheet



Battery (optional)	Output Power 5000W
Type	Lead-Acid or Li-Ion
Nominal DC Input	48V
Capacity	50 — 9900Ah
Voltage Range	43.0 — 63.0V
Continuous Battery Charging Output	120A
Charging Curve	3-Stage w/ Equalization
Grid to Batt Charging Efficiency	96.0%
External Temperature Sensor	Included
Current Shunt for Accurate % SOC	Integrated
External Gen Start Based on Voltage or %SOC	Integrated
Communication to Lithium Battery	CanBus & RS485

Solar	Input Power 5000W
Max Allowed PV Power	3250W + 3250W = 6500W
Max PV Power Delivered to Battery & AC Outputs	5000W
Max DC Voltage (Voc)	500V @ 18A, 450V @ 20A
MPPT Voltage Range	150-425V
Starting Voltage	125V
Number of MPPT	2
Max Solar Strings Per MPPT	2
Max DC Current per MPPT (Self Limiting)	10A
Max AC Coupled Input (Micro/String Inverters)	9600W

General	
Dimensions (H x W x D)	30.0" x 18.3" x 10.0"
Weight	78 lbs
Enclosure	NEMA 3R
Ambient Temperature	-25-55°C, >45°C Derating
Installation Style	Wall-Mounted
Wi-Fi & LAN Communication	Included
Standard Warranty (verified by HALT Testing)	5 Years

AC	Output Power 5kW On-Grid & Off-Grid
Connections	120/240/208V Split Phase
Continuous AC Power to Grid (On-Grid)	5000W 33A-L (240V)
Continuous AC Power to Load (Off-Grid)	5000W 33A-L (240V)
Surge AC Power 10sec	16,000VA L-L (240V)
Surge AC Power 100ms	25,000VA L-L(240V)
Parallel Stacking	No
Frequency	60/50Hz
Continuous AC Power with Grid or Generator	15120W 63A L-L (240V) 7560W 63A L-N (120V)
CEC Efficiency	96.5% (Peak 97.5%)
Idle Consumption Typical—No Load	60W
Sell Back Power Modes	Limited to Household/Fully Grid-Tied
Design (DC to AC)	Transformerless DC
Response Time (Grid-Tied to Off-Grid)	4ms
Power Factor	+/- 0.9 - 1.0

Protections & Certifications	
Electronics Certified Safety by SGS Labs to NEC & UL Specs - NEC 690.4B & NEC 705.4/6	Yes
Grid Sell Back — UL1741-2010/2018, IEE-E1547a-2003/2014, FCC 15 Class B, UL1741SA, CA Rule 21, HECO Rule 14H	Yes
PV DC Disconnect Switch — NEC 240.15	Integrated
Ground Fault Detection — NEC 690.5	Integrated
PV Rapid Shutdown Control — NEC 690.12	Integrated
PV Arc Fault Detection — NEC 690.11	Integrated
PV Input Lightning Protection	Integrated
PV String Input Reverse Polarity Protection	Integrated
AC Output Breakers - 63A	Integrated
250A Battery Breaker / Disconnect	Integrated
Surge Protection	DC Type II / AC Type II

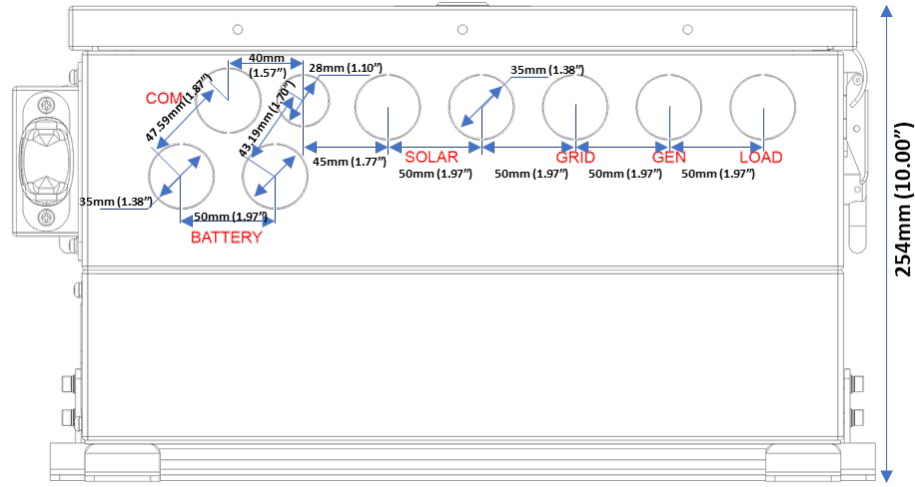
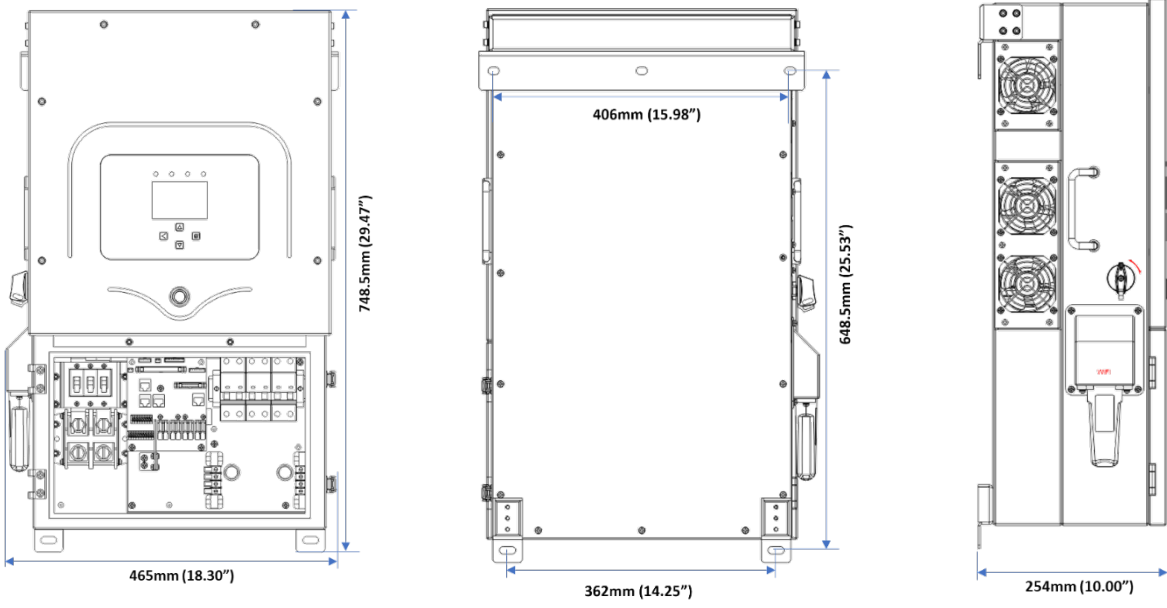

6" minimum clearance

6" 6"

**Temperature Derating**

DC: 90C-100C Shutdown @ 100C

AC: 75C-82C Shutdown @ 82C

### Sol-Ark 5K Torque Values Application Note

Load Breaker	26.5 IN Lbs	3 NM
Grid Breaker	26.5 IN Lbs	3 NM
Gen Breaker	26.5 IN Lbs	3 NM
Neutral / Ground Busbars	26.5 IN Lbs	3 NM
Cover Screws	26.5 IN Lbs	3 NM
Battery Connection	90.0 IN Lbs	10 NM

**! Do Not Use Impact Drivers to Tighten Any Fasteners on the Sol-Ark.**

**PV input: 10AWG**

**All AC Inputs/Outputs: 6-4AWG**

**All Sensors: 20-24AWG**

**CT Sensors: 10' Wire Included**

**Batt Temp Sensor: 6' Wire Included**

**RJ45 Cable: 7' Included (Extendable up to 20')**

**Battery input: 2/0-4/0AWG (3/8" Lugs)**

15.875mm (5/8in)

23.813mm (15/16in)

2/0 AWG Max

4/0 AWG Max

Small  
Limiter  
Sensor

Large  
Limiter  
Sensor

100A: 50mA

200A: 0.1A

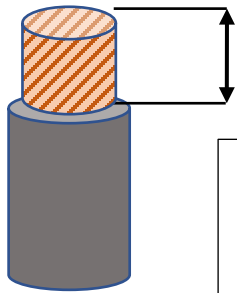

15.875mm (5/8in)

PV Panel Inputs

0' – 100': 12 AWG

100' – 300': 10 AWG

10 AWG Max

25.4mm (1.0in)

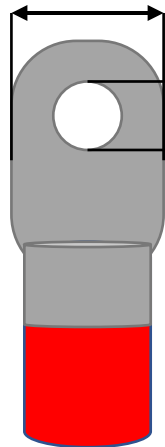

10mm

DC Battery Input

0' – 12': 2/0 AWG

12' – 20': 4/0 AWG

4/0 AWG Max

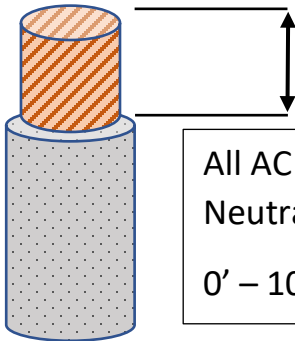

15.875mm (5/8in)

All AC Inputs / Outputs /  
Neutral Connections

0' – 100': 6 AWG

4 AWG Max

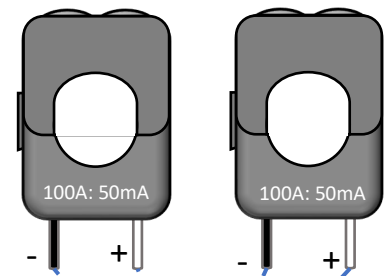

100A: 50mA

100A: 50mA

All Sensor Inputs

0' – 100': 24 AWG

100' – 400': 23 AWG CAT 6

Extensions for Limiter Sensors  
must be twisted pair

**(Shielded CAT6 Recommended)**

CAT  
6

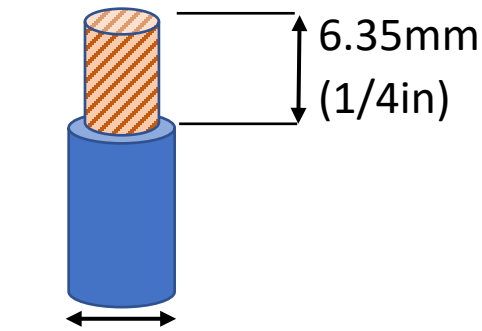

6.35mm  
(1/4in)

20 AWG Max





These Single Line Diagrams (SLDs) are examples of common use-cases for Sol-Ark inverters.

Sol-Ark does not provide custom diagrams; however, you may contact [support@sol-ark.com](mailto:support@sol-ark.com) for any questions about an existing SLD.

## Sol-Ark Off-Grid Standard Wire Diagram 120V/240V

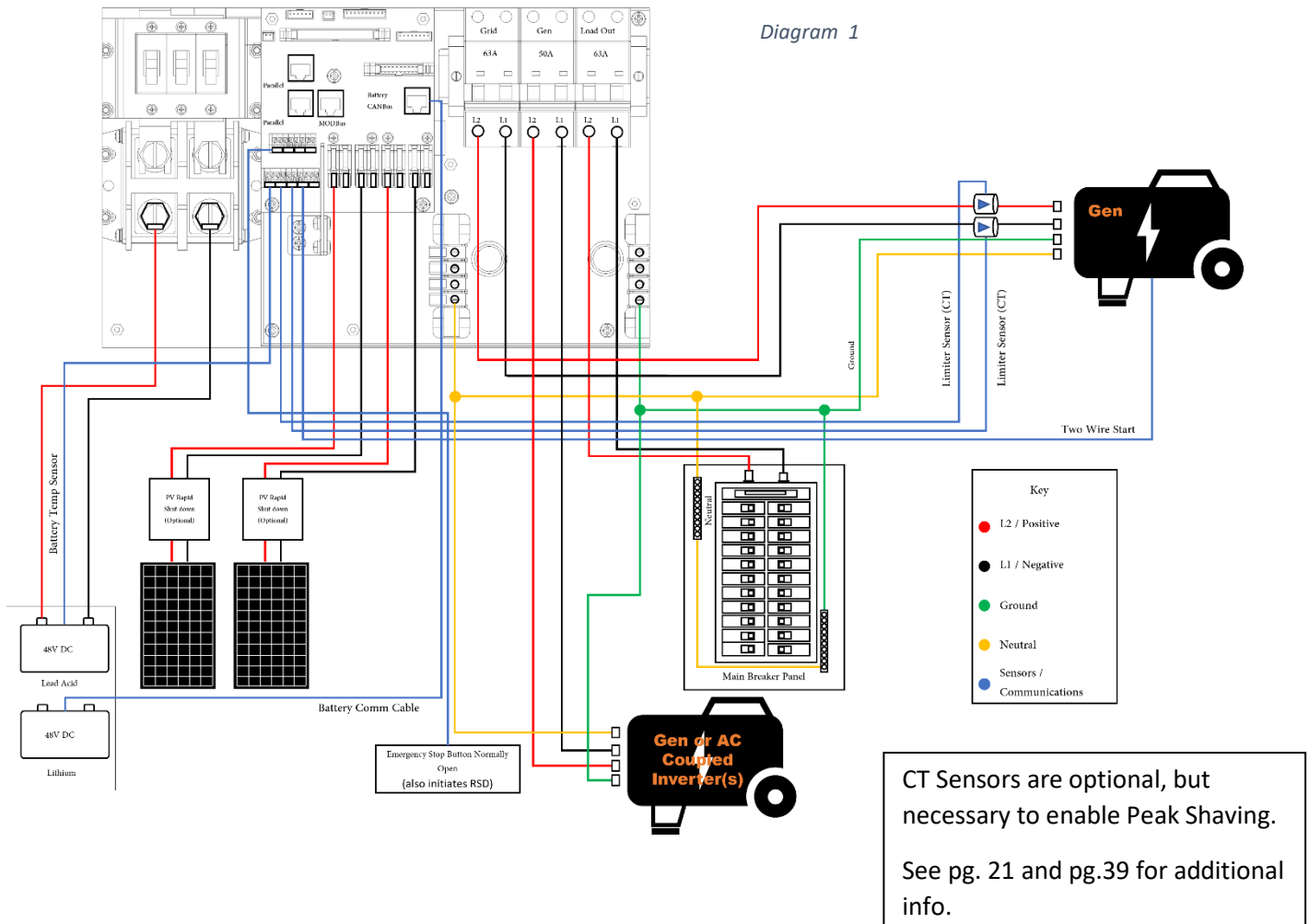



Diagram 2

# Sol-Ark Standard Wire Diagram 120V/240V

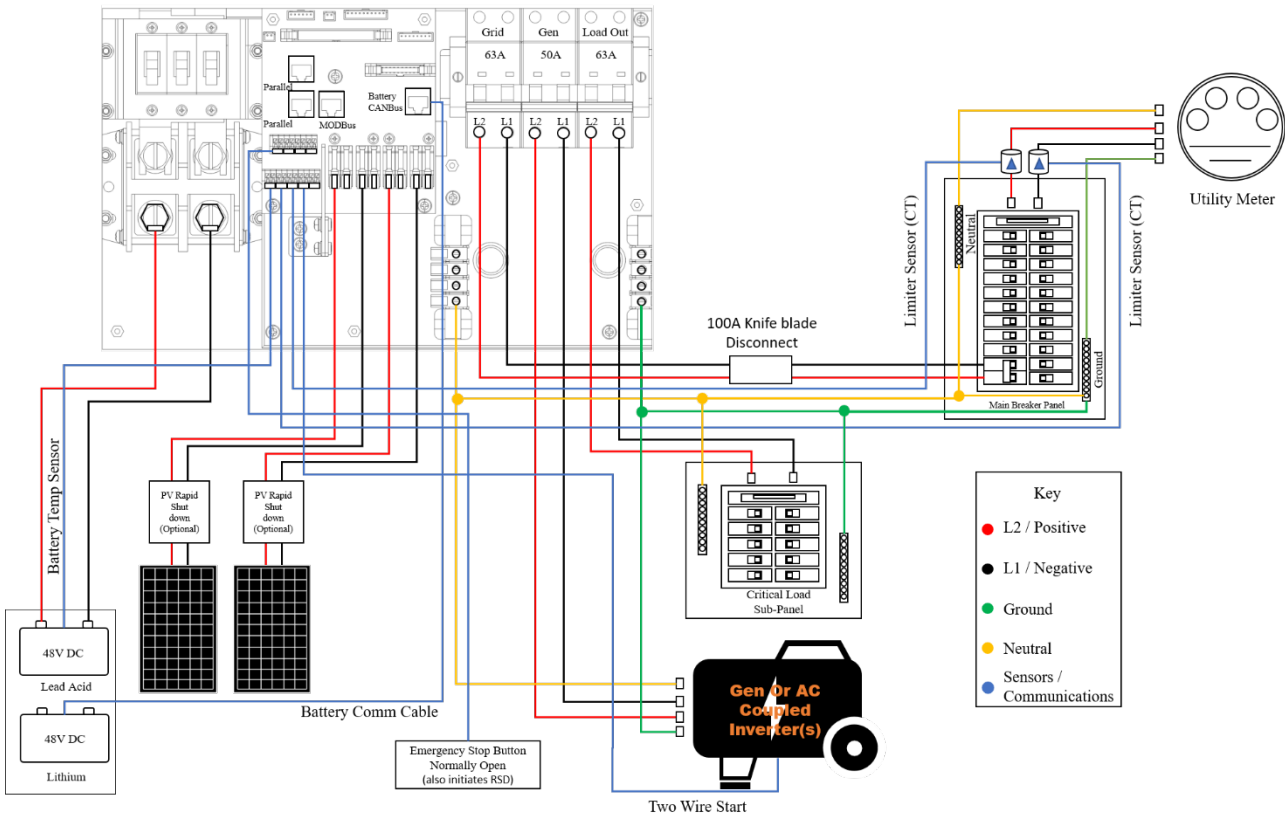
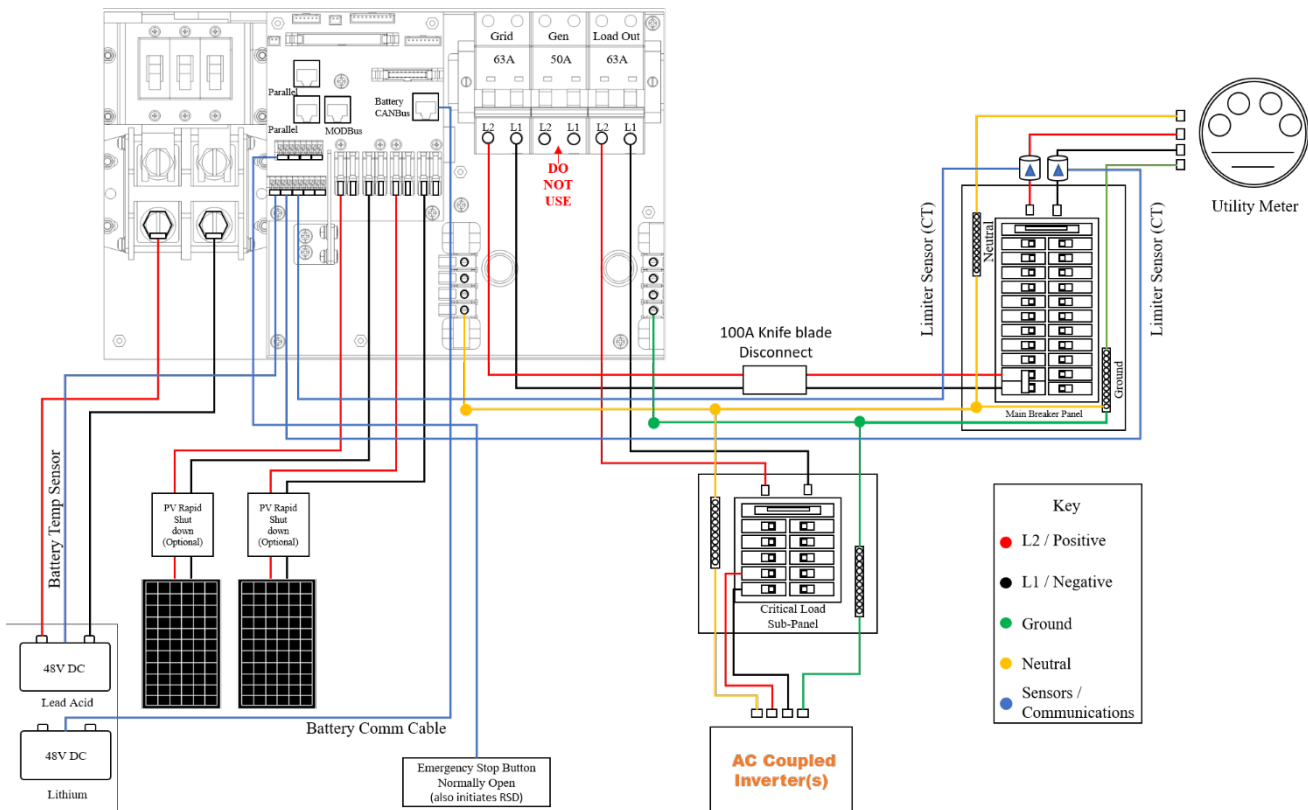

Diagram 3

# Sol-Ark Load Side AC Coupled Wire Diagram 120V/240V



# Sol-Ark Whole Home Generator Wire Diagram 120V/240V

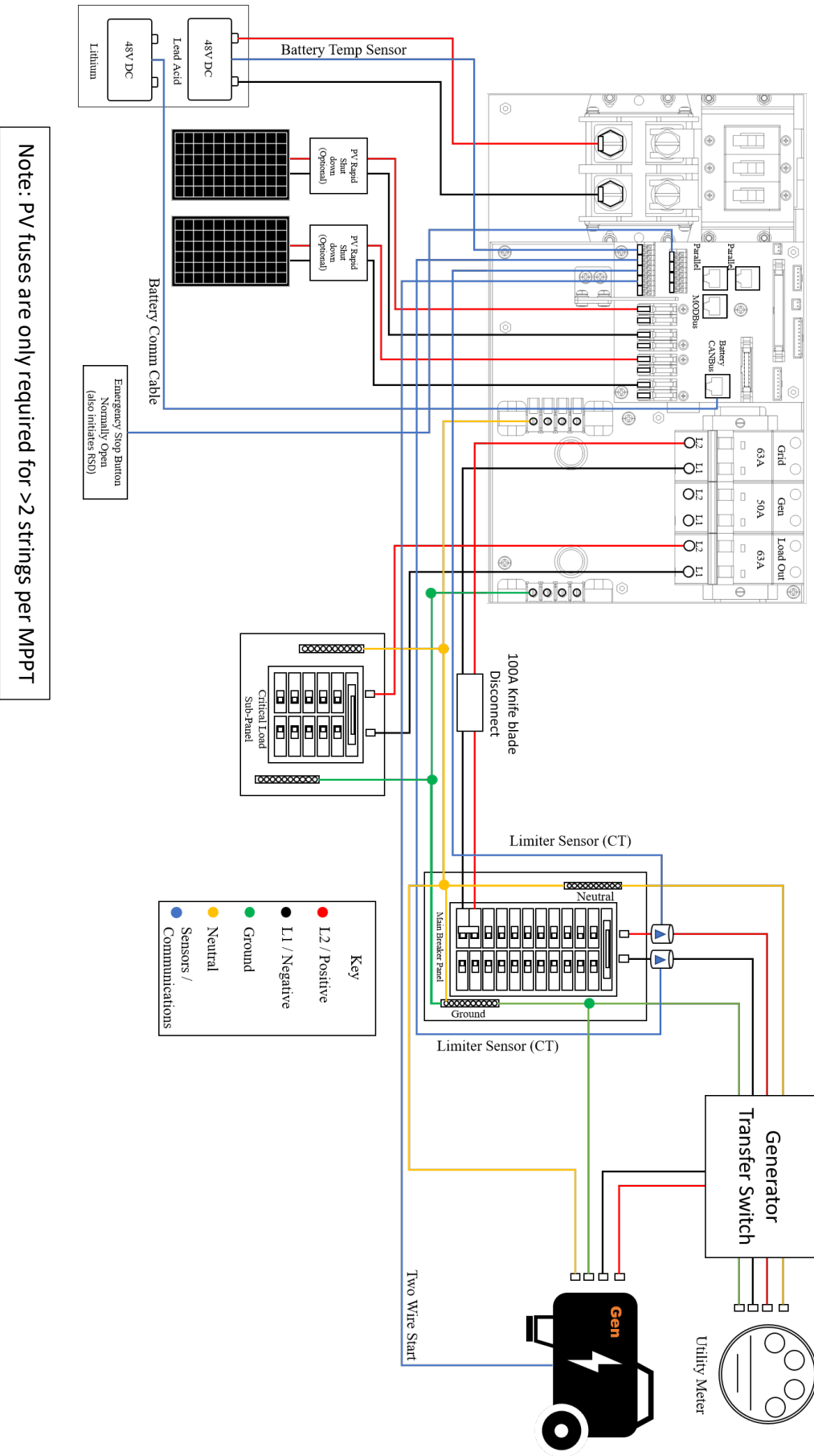
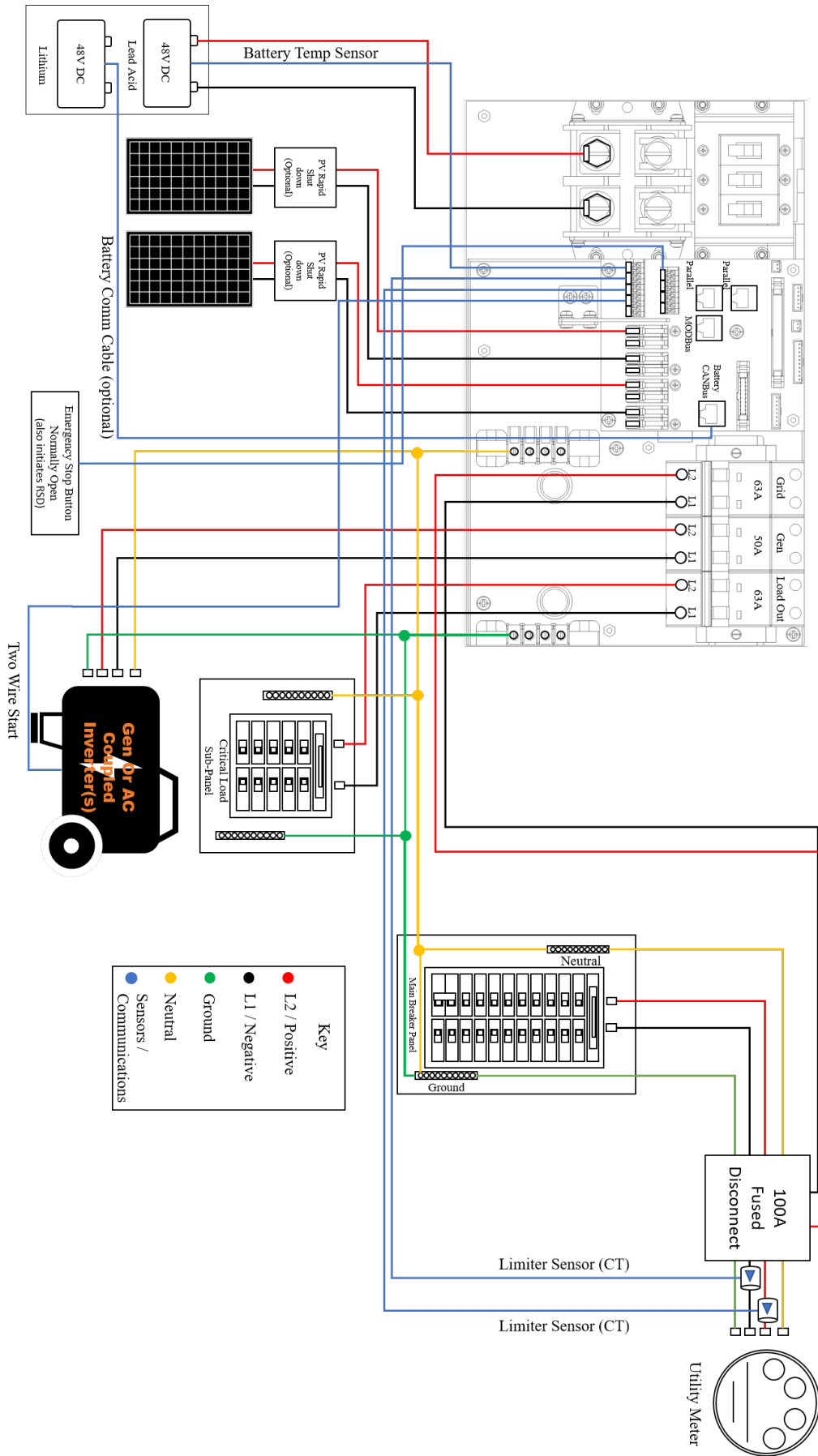

Diagram 4

# Sol-Ark Line Side Tap Wire Diagram 120V/240V



Note: PV fuses are only required for > 2 strings per MPPT

Diagram 5

## Main Menus

Solar Today=53KWH Total=559.8KWH

5.00  
KW

-1.60  
KW

2.00  
KW

-1.40  
KW

Solar	Grid	INV	USP LD	Batt
3882W	-3081W 60.0Hz	3702W 60.0Hz	621W 122V	-26W
L1: 263V	126V	122V	0W	54.70V
5.4A	HM: -786W	15.2A	121V	-0.53A
1398W	LD: -1876W	1857W	640W	25.0C
L2: 264V	122V	121V	<b>Gen</b>	<b>TEMP</b>
9.5A	HM: 1142W	14.8A	4V	DC: 55.0C
2484W	LD: 1205W	1845W	0.0Hz	AC: 49.7C
			0W	

System Setup 1/25/2021 03:05:27 PM Mon.

Basic Setup

System Alarms

Battery Setup

Li-Batt Info

Grid Setup

Sol-Ark 5k/8k/12k-P  
 - ID: ##### SD  
 - COMM: ####  
 - MCU: Ver####

System Alarms 1/25/2021 03:05:27 PM Mon.

Alarms Code	Occurred
F13 Grid_Mode_changed	2021-01-13 11:22
F13 Grid_Mode_changed	2021-01-13 11:20

0.00 V	0.00 A	0.0 C	0%	0 Ah
0.0 V	0.0 V	0A	0A	0x00 0x00

Only w/ BMS Lithium Mode

1. 0.00V	0.00A	0.0C	0.0%	0.0V	0.0A	0 0 0
2. 0.00V	0.00A	0.0C	0.0%	0.0V	0.0A	0 0 0
3. 0.00V	0.00A	0.0C	0.0%	0.0V	0.0A	0 0 0
4. 0.00V	0.00A	0.0C	0.0%	0.0V	0.0A	0 0 0
5. 0.00V	0.00A	0.0C	0.0%	0.0V	0.0A	0 0 0
6. 0.00V	0.00A	0.0C	0.0%	0.0V	0.0A	0 0 0
7. 0.00V	0.00A	0.0C	0.0%	0.0V	0.0A	0 0 0
8. 0.00V	0.00A	0.0C	0.0%	0.0V	0.0A	0 0 0
9. 0.00V	0.00A	0.0C	0.0%	0.0V	0.0A	0 0 0
10. 0.00V	0.00A	0.0C	0.0%	0.0V	0.0A	0 0 0
11. 0.00V	0.00A	0.0C	0.0%	0.0V	0.0A	0 0 0
12. 0.00V	0.00A	0.0C	0.0%	0.0V	0.0A	0 0 0
13. 0.00V	0.00A	0.0C	0.0%	0.0V	0.0A	0 0 0

## Basic Setup

**Basic Setup**

Display | Time | Advanced | Factory Reset | Parallel

Brightness

Auto Dim  600S

Beep

CANCEL OK

**Basic Setup**

Display | Time | Advanced | Factory Reset | Parallel

AM/PM

Year: 2021 | Month: 10 | Day: 26

Hour: 03 | Minute: 04 | Second: 15

Time Sync

Seasons: Season1 (1-1), Season2 (4-1), Season3 (8-1)

CANCEL OK

**Basic Setup**

Display | Time | Advanced | Factory Reset | Parallel

Solar Arc Fault ON

Gen peak-shaving Power: 8000W

Grid peak-shaving Power: 8000W

Auto detect Home Limit Sensors CT ratio: 2000

CANCEL OK

**Basic Setup**

Display | Time | Advanced | Factory Reset | Parallel

Factory Reset

System selfcheck

Lock out all changes

Test Mode

Lock Grid Charging & Limited

CANCEL OK

**Basic Setup**

Display | Time | Advanced | Factory Reset | Parallel

Parallel:  Master  Slave

Modbus SN: 00

Phase A  Phase B  Phase C

Meter Select:  Meter > Grid  Meter > Load

No Meter

CANCEL OK

# Battery Setup

### Batt Setup

Batt Capacity	200Ah	<input type="checkbox"/> Use Batt V Charged
Max A Charge	100A	<input checked="" type="checkbox"/> Use Batt % Charged
Max A Discharge	185A	<input type="checkbox"/> No Battery
TEMPCO	-0mV/C/Cell	<input type="checkbox"/> BMS Lithium Batt <input type="text" value="00"/>
		<input checked="" type="checkbox"/> Activate Battery

CANCEL OK

### Batt Setup

StartV	49.0V	49.0V	Float V	54.8V
Start%	30%	30%	Absorbtion V	55.5V
A	40A	100A	Equalization V	55.5V
		30 Days	0.0 Hours	
<input type="checkbox"/> Gen Charge		<input checked="" type="checkbox"/> Grid Charge		
Generator Exercise Cycle Day & Time>> Mon 08 :00 20min				
<input type="checkbox"/> Gen Force		CANCEL OK		

### Batt Setup

Shutdown	46.0V	20%	Batt Resistance	25mOhms
Low Batt	47.5V	30%	Batt Charge Efficiency	99.0%
Restart	52.0V	40%		
Batt Empty V	47.0V	<input type="checkbox"/> BMS_Err_Stop		

CANCEL OK

### Batt Setup

<input checked="" type="checkbox"/> Use gen input as load output	<input type="checkbox"/> For AC Coupled Input to Gen
<input checked="" type="checkbox"/> On Grid always on	High Frz <input type="text" value="62.00Hz"/>
Smart Load OFF Batt	<input type="text" value="51.0V"/> <input type="text" value="80%"/> <input type="checkbox"/> AC couple on load side
Smart Load ON Batt	<input type="text" value="54.0V"/> <input type="text" value="90%"/>
Solar Power(W)	<input type="text" value="500W"/>

CANCEL OK

# Grid Setup

### Grid Param

Grid Sell	08000
Limited Power to Home	05:00AM 2000 50%
<input checked="" type="checkbox"/> Limited Power to Load	09:00AM 2000 100%
Time of Use	Setup
	01:00PM 2000 100%
	05:00PM 2000 50%
	09:00PM 2000 50%

CANCEL OK

### Time of Use Setup

Mon.  Tues.  Wed.  Thur.  
 Fri.  Sat.  Sun.  
 Season1  Season2  Season3

CANCEL OK

### Grid Param

<input checked="" type="checkbox"/> General Standard	Grid Reconnect Time	60s
<input type="checkbox"/> UL1741 & IEEE1547	Power Factor	1.000
<input type="checkbox"/> UL1741SA	<input checked="" type="checkbox"/> GEN connect to Grid Input	
	Zero Export Power	20W
	<input checked="" type="checkbox"/> Batt First <input type="checkbox"/> Load First	

CANCEL OK

### Grid Param

Grid Frequency	50Hz	<input checked="" type="checkbox"/> 60Hz
Grid Type	<input type="checkbox"/> 220V Single Phase <input checked="" type="checkbox"/> 120/240V Split Phase <input type="checkbox"/> 120/208V 3 Phase	
Grid Vol High	270V	
Grid Vol Low	185V	
Grid Hz High	65.0Hz	
Grid Hz Low	55.0Hz	

CANCEL OK

### Grid Param

L/HVRT	L/HFRT
HV2: 252.0V 0.16S	HF2:62.00Hz 0.16S
HV1: 231.0V 12S	HF1:60.50Hz 299S
LV1: 184.8V 20S	LF1:58.50Hz 299S
LV2: 147.0V 10S	LF2:57.00Hz 0.16S
LV3: 105.0V 0.16S	

CANCEL OK

### Grid Param

Q(V)	FW	VW
V1:216.0V Q1: 0.44	Estart:60.50Hz	Vstart:254.4V
V2:225.6V Q2: 0.00	Fstop:62.00Hz	Vstop:264.0V
V3:254.4V Q3: 0.00	RT:5.0s	RT:10s
V4:264.0V Q4: 0.44	Normal Ramp rate	10.0%/s
Response Time 10s	Soft Start Ramp rate	10.0%/s

CANCEL OK

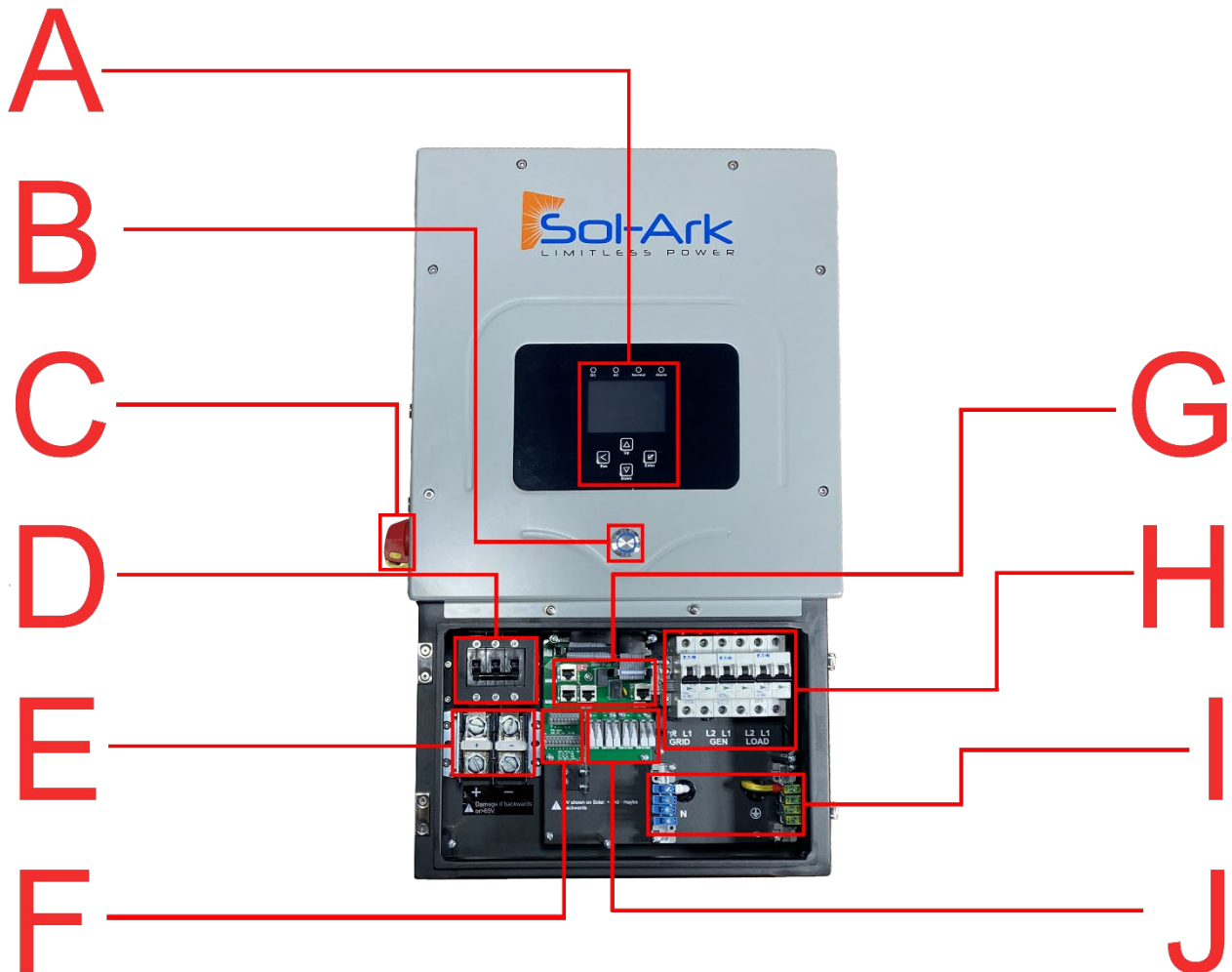

- A. LCD Touch Screen**
- B. Power Button**
- C. PV DC Disconnect Switch**
- D. 250A Battery Breaker**
- E. Battery Terminals (+/-)**

- F. Sensor Pin-Out Board**
- G. Comms/Paralleling Ports**
- H. AC Breakers (Grid 63A/Gen 50A/Load 63A)**
- I. Neutral/Ground Bus Bar**
- J. MPPT Charge Controllers**

## Deciding Backup Circuits

- A. We recommend subpanels and require them if you have Arc-Fault / GFI breakers
- B. Ensure you keep the inverter within its amperage limits
  - ON-Grid = 63A Continuous (pass-through)
  - OFF-Grid = 37.5A Conutuous | 67A Peak (10s) | 104A Peak (100ms)
- C. Verify each load circuit by measuring typical and max Amps with a clip-on Amp meter. Amps x 120V = Watts
- D. Install a subpanel for backup loads if you have Arc-Fault / GFI breakers, NOT a multi-circuit transfer switch

## Single System Installs

- Install Double Pole 60A breaker in Main Panel for Grid In/Out
- Best practice to install at the opposite end of the bus bar from the main breaker, which is usually at the bottom of the breaker panel (see figure above)

## Mounting the Sol-Ark

- Keeping in mind Sol-Ark's dimensions, find a suitable location for the system (s)
- NEMA 3R rating for Outdoor installations
- PROTECT the LCD screen from excessive UV exposure**
- System weight = 78lbs (35kg). Securely attach to the wall. Affix a mounting board to studs using 6-8 screws
- Using 2-3 screws + washers (choose screw length and surface type) to mount the French Cleat to the board/wall
- Mount Sol-Ark on the installed French Cleat / Ensure Sol-Ark is level and sits properly
- Add two screws for the bottom mount



## Integrating Batteries (Sol-Ark POWERED "OFF")

- Connect batteries to Sol-Ark as shown in Fig. B below
- Install included toroids (Part e. on pg. 4) on battery input cables as shown in Fig. A to the right
- Ensure the built-in battery disconnect is OFF while connecting batteries, or arcing may occur



Fig. A

## Multi-System Installs

- ALL paralleled systems MUST connect to the same large battery bank, each with its own cables attached
- Do NOT use separate battery banks for parallel systems**



Sol-Ark 5K is a **48V** system. Do NOT wire the battery bank to any other nominal voltage.

When using 12V batteries do not exceed FOUR (4) batteries in series.

When using other battery chemistries, stay within the voltage range: MIN 43V-MAX 63V

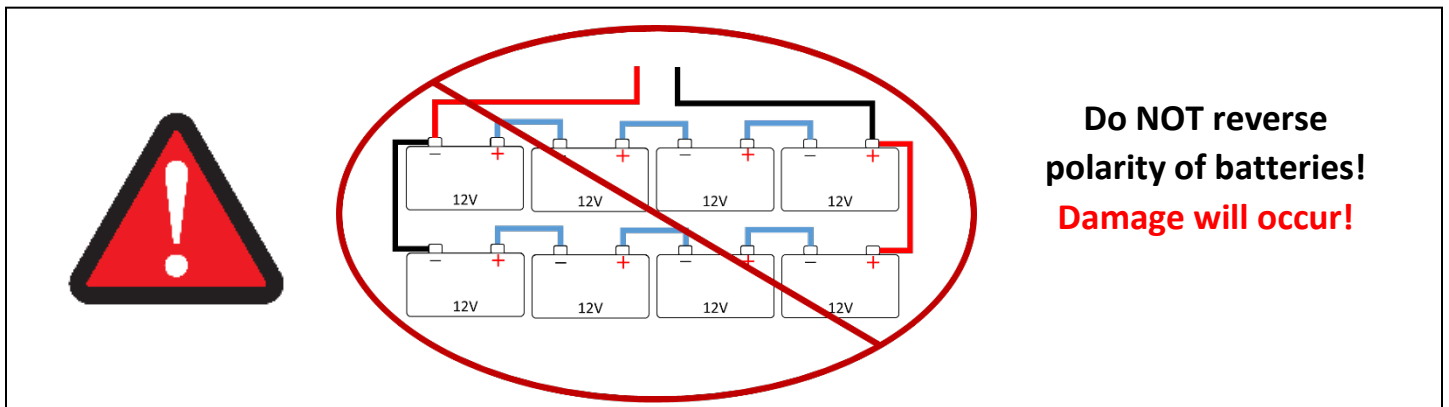



## E.M.P Systems Only

### Suppressor installation

- If your system was purchased with Lightning / EMP Hardening, the vast majority of protection is in the Sol-Ark. However, you also have EMP suppressors that get installed on the power cords of appliances that are connected to the transfer switch. Although not critical, it is recommended they be installed as close as possible to the appliance.
- You also have EMP suppressors that get installed on both solar panel wires with a zip tie. Closer to the panel is better. If you purchased the panels from us, we already installed >150kV/m protection inside the solar panels.

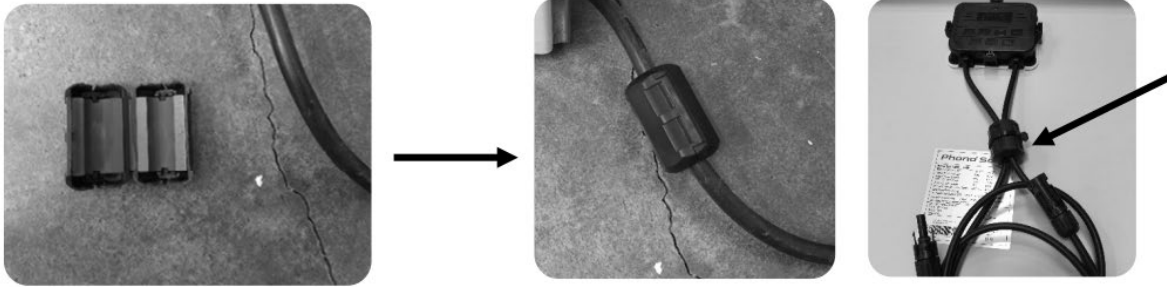

If using panels not from Sol-Ark

## Connecting Solar Panels

- Sol-Ark has DUAL MPPTs for two separate PV input pairs
- MAX PV input = 6.5kW ( $\pm 5\%$ ) / system | 3.25kW / MPPT | MAX 500V<sub>OC</sub> PV | MAX I<sub>SC</sub>/MPPT 10A (limiting to 10A)



**Damage will occur if PV V<sub>OC</sub> > 550V**

- Parallel strings per MPPT must be the same Voltage
  - PV1 A/B must be the same voltage if using both strings
  - Panels on the same MPPT CAN face different directions
- Ground the panel MOUNTS/FRAMES to any ground in the Home via 12AWG wire
- Connect the solar panel strings as indicated by the following diagram:



Each string **can** use separate wires

String minimum is usually 5 panels or 175V

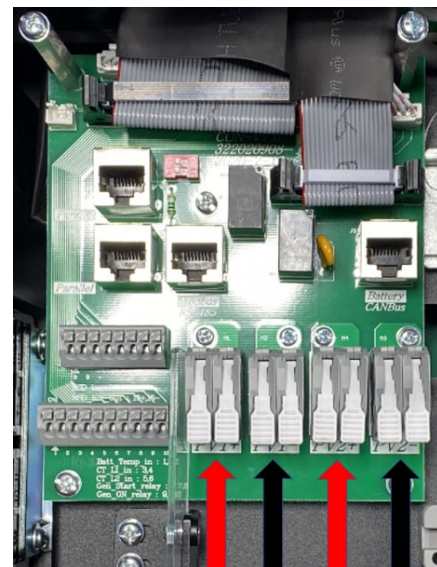
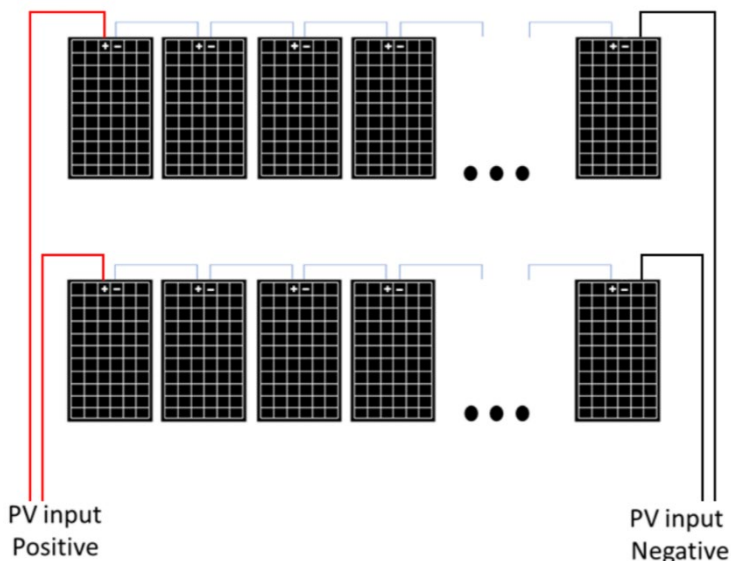

## Integrating a Generator

### Generators < 10kW (GEN Breaker)— See Diagram 1

- A. ONLY supports 240V / 208V generators | 50A breaker
- B. Connect the generator output to the "GEN" input breaker in the Sol-Ark 5K user area
- C. THD of less than 15% preferred but not required

### Standby Generators > 10kW (GRID Breaker)— See Diagram 3 (OFF-GRID)

- A. Supports 220V / 240V / 208V generators | Depends on "Grid Type" selection | 63A breaker
- B. **Off-Grid** / Whole-home Generator on ATS installations require selecting "GEN Connected to Grid Input"  
**Home Screen → Gear Icon → Grid Setup → Sell Control → GEN Connected to Grid Input**
- C. Off-Grid = turn "Grid Sell" off | Only need CT's (on Gen lines) if using GEN Peak Shaving (see below)



#### Increase Gen/Sol-Ark efficiency

1. Select "Limited to Load"
2. Select "General Standard"
3. Increase Grid frequency range: 55-65H

### Weekly Gen Exercise

If the Sol-Ark is up to date with MCU version xx73 or newer, and your generator has two-wire start compatibility, you will experience weekly generator tests.

These tests occur at 8AM (local time) every Monday by default.

The test takes approximately 20 minutes to complete. During that time, the generator will auto-start and auto-stop.

The generator will not provide power during this test. The generator may charge the batteries if the batteries reach designated generator start point, however.

## GEN Peak Shaving Mode

- A. Prevents the Sol-Ark from overloading small generators
- B. Must place the CT sensors so that they measure L1 and L2 of the generator's output, pointing arrows on the CT's towards the generator
- C. Sol-Ark contributes power above the "Power" value threshold to prevent overloading the generator
- D. This mode will auto-adjust the Gen Charge Amperage to avoid overloads

Basic Setup	
Display	Time
<input type="checkbox"/> Solar Arc Fault ON	<input type="checkbox"/> Clear Arc_Fault
<input checked="" type="checkbox"/> Gen peak-shaving	Power: 8000W
<input type="checkbox"/> Grid peak-shaving	Power: 8000W
<input type="checkbox"/> Auto detect Home Limit Sensors	CT ratio: 2000
<div style="text-align: right;">ARC parameters</div> 030000 045000 000400 000050 000390 000055 238094	
<input type="button" value="CANCEL"/> <input type="button" value="OK"/>	

## Gen Start V or %

Value batts need to reach **BEFORE** automatically starting a generator connected to the GEN breaker to charge the battery bank.



Sol-Ark will NOT charge batteries from a generator until the batteries reach this value.

## Gen Start A

This is how many amps you can pull specifically from the Generator (GEN breaker only) to charge the batts. To ensure you do not overload a small Generator, you will want to adjust the GEN charge value. Multiply value by # of Sol-Arks for actual current value into batteries.

Batt Setup			
Batt	Charge	Discharge	Smart Load
StartV	49.0V	49.0V	Float V: 54.8V
Start%	30%	30%	Absorbtion V: 55.5V
A	40A	100A	Equalization V: 55.5V
			30 Days
			0.0 Hours
<input checked="" type="checkbox"/> Gen Charge	<input type="checkbox"/> Grid Charge		
<input type="button" value="CANCEL"/> <input type="button" value="OK"/>			



**Suppose PV production = 0W | Disabled TOU | Enabled Grid/Gen Charge:** the batteries will be charged to "full" using the Grid or a Generator (if available) until the battery bank accepts only 5% of its rated capacity in Amperes. This value correlates to roughly 90-93% full for most batteries and is the generator's default "OFF" signal. If producing PV, the system will use PV to charge the batteries to 100% full instead.

# Integrating Sensors and Accessory Placement

## Sensor Pin Out (Located in Sol-Ark user)

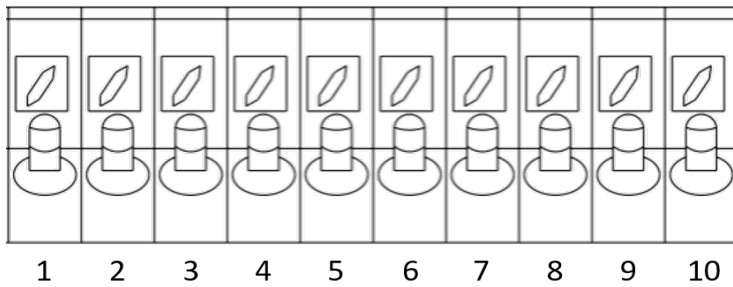
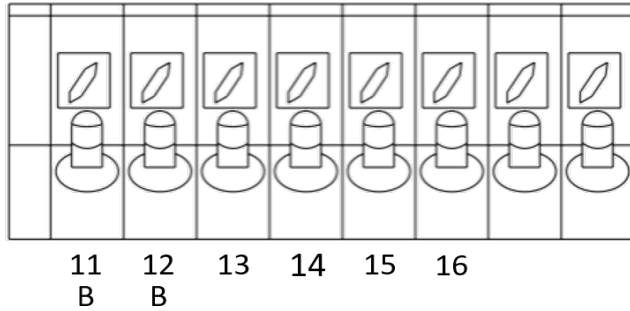

**(1,2) Batt Temp:** Battery Temperature Sensor has no polarity and is needed for voltage correction when using lead acid batteries.

**(+3, -4) CT1 & (+5,-6) CT2:** Current transformers used for limited to home mode and peak shaving

**(7,8) Gen Start Relay:** Two wire start for generators, simple open or closed relay

**(9,10) Gen On Relay:** Not currently used

**(B 11, B 12) Emergency Stop:** Short these pins to initiate emergency stop. This will shutdown AC output from the inverter and initiate rapid shutdown of the PV.

**(+13, -14) Optional 12V input signal** for RSD

**(+15, -16) 12V power supply for RSD transmitters:** such as TIGO and Midnite  
 Rated for a **maximum of 1.2W (100mA @12V)**

## Battery Temperature Sensor

- Place between batteries with tape (See Fig. C).
- This sensor has no polarity and helps perform voltage charging adjustments and capacity calculations.



**Note:** Lithium Batteries do NOT require a Temperature sensor.

Fig. C

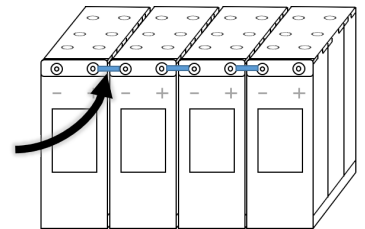

## Limiter Sensors (CT Sensors)

- Install sensors on incoming electrical service wires on L1 and L2 (see Diagrams Section)
- Limited To Home Mode (meter zero) and Peak Shaving Modes require CT sensors
- CT winding default ratio is 2000:1; however, this ratio is programmable
- To ensure the sensors will fit, please check the wire size before ordering

## GEN Start Signal (Two-Wire)

- The signal comes from a normally open relay that closes when the Gen Start state is active

## CANbus & RS485

- To connect batteries to the Sol-Ark 5K via RJ45, you need to splice the end connecting to the Sol-Ark 5K
- Use the middle two conductors
- RS485 is SunSpec draft 4 (will not work with draft 3)

## Wi-Fi Antenna (Dongle)

Remote monitoring and software updates require an internet connection through the Wi-Fi dongle

## Emergency Stop Signal & PV Rapid Shutdown Signal

Pins 11 and 12 use a normally open & latching switch to connect the two emergency stop pins that cut off the RSD power supply when triggered, thus stopping the inverter AC output.

Pins 15 and 16 provide the 12V / 100mA signal power lost when the Sol-Ark shuts down using the front button.

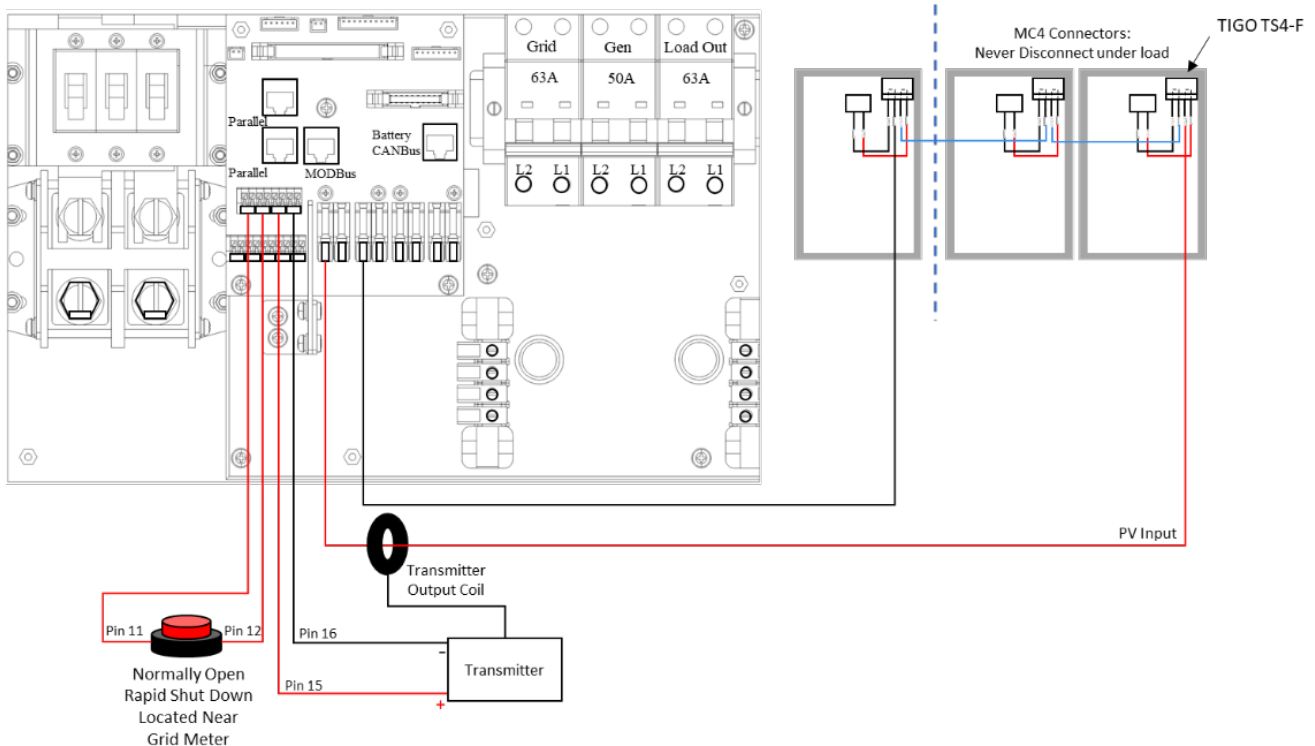

Emergency Stop Diagram (Only available on select hardware versions | Shown with TIGO TS4)

**Rapid Shutdown:** TIGO TS4-A-O | TIGO TS4-A-F | TIGO TS4-O | TIGO TS4-O-DUO | APsmart RSD S-PLC / RSD-D

**PARALLEL SYSTEMS: Emergency Stop should be connected to the Master with address 01 and will initiate emergency stop for all paralleled systems from the one button**



- The Built-in 12V power supply in the user area of the Sol-Ark (Pins 15 and 16) is rated for 100mA (1.2W)
- Transmitter fits inside the user area of the Sol-Ark 5K but can cause interference (sometimes requires placing it outside of the user area)
- TIGO Optimizers are compatible with the Sol-Ark 5K (Do not use the built in 12V Power supply in the Sol-Ark user area to Power the Tigo Optimizer TX transmitter)

## Misc. Hardware Recommendations

**Disconnect / Transfer Switches:** 200A Non-Fused Transfer Switch Model #TC10324R (GE) | 200A Fused Transfer Switch Model #DG224NRK (Eaton)

**PV Fuses:** 15A PV MC4 in-line fuse holder (ZOOKOTO or DPJ)

**Electrical Panel:** Any appropriately rated panel for your loads (Check local hardware stores for recommendations)

# Powering-Up and Testing the Sol-Ark 5K

## Check the voltage on each PV input circuit

- A. Should be no higher than 500Voc Temp. corrected
- B. DO NOT connect PV+ OR PV- to GND**
- C. Verify polarity (backward polarity shows 0V)

## Check Grid Input Voltage

- A. Measure L1 to Neutral and L2 to Neutral. Ensure 120Vac
- B. Measure L1 and L2 Ensure 240Vac
- C. Check Neutral and Ground are ~0V AC
- D. Verify L1 voltage on AC in/out is 0Vac with the main L1 connection in the panel Same for L2

## Check Battery Voltage

- A. Turn on the battery switch (if using a Lithium battery)
- B. Turn on the built-in battery disconnect in the user area
- C. The voltage should be 45Vdc-60Vdc

## Provide Power to Sol-Ark

- A. Turn on Grid Breaker and Load Breaker
- B. Turn PV disconnect switch to the "ON" position
- C. Press the ON/OFF Button on the front, and the blue light should turn on

## Indicator LED's

### DC

- A. Green = DC Solar Panels are producing
- B. Off = Solar Panels are not producing

### AC

- A. Green = Grid (or Gen or AC Coupled) is Connected
- B. Off = grid is not Connected

### Normal

- A. Green = Sol-Ark 5K is working properly
- B. Off = Sol-Ark 5K is not working properly

### Alarm

- A. Red = Alarm, check the alarms menu
- B. Off = No alarms



Turn ON with one of three sources of power:  
1) PV      2) Grid      3) ON/OFF Battery

## Power Cycle Sequence

1. Turn on the Built-In battery disconnect
2. Make sure that Sol-Ark 5K is properly connected to the batteries, panels, grid, etc. (see system wiring diagram).
3. Turn on grid power breakers.
4. Press the power button on the front of the unit.
5. Make sure Solar panel inputs are not connected to Ground, then Turn on DC disconnect switch.
6. Turn on load breakers.
7. Reverse the steps to turn off

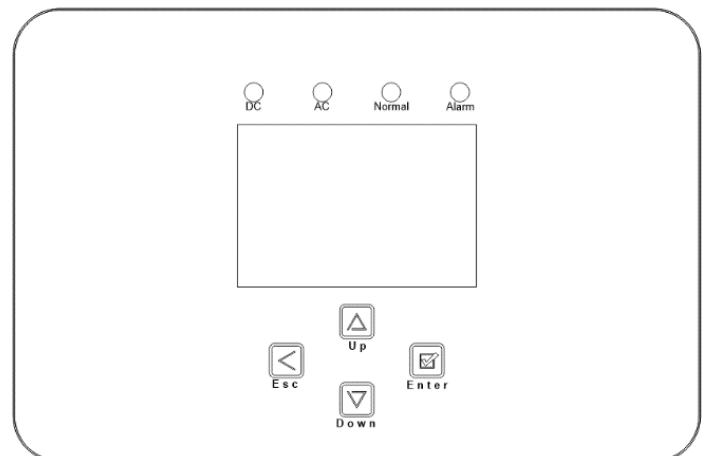

## Remote Monitoring Setup

### Ethernet Dongle

- Open the dongle enclosure and thread the ethernet cable through the hole and plug into the RJ45 port
- Reassemble the dongle housing and plug dongle into Sol-Ark and secure with screws  
If all is well, you will see solid red and green lights
- Register the dongle via the app or [www.mysol-ark.com](http://www.mysol-ark.com)

### Wi-Fi (Via Cell Phone or computer)

- Plug Wi-Fi dongle into Sol-Ark
- Using your device look for an "EAP" network containing the last 5 digits of the dongle S/N
- Password: 12345678
- Follow the instructions in the upcoming pages



You can access PowerView on a computer with the following link:

<http://www.mysol-ark.com>



## Download PV Pro App



iPhone: (Will only show up as PV Pro)  
<https://apps.apple.com/lk/app/powerview-pro/id1247121391>



Android  
[https://play.google.com/store/apps/details?id=com.elinter.app.powerview&hl=en\\_US&gl=US](https://play.google.com/store/apps/details?id=com.elinter.app.powerview&hl=en_US&gl=US)

### Attention Installers

If you plan to add an install to your installer account for monitoring multiple installs, you must first make the plant under the **customer's** account.

Once created, the customer can share the plant, with **Manager permissions**, to the installer via the app ("..." next under My Plants) or webpage (press the "..." next to the plant name in Power View).





## Create an Account and Sign In

Account login

Please input your E-mail

Password

Sign Up | Forgot Password

Sign Up

Phone Number

Please input E-mail

Please input verification code GET CODE

Password

Click [CONFIRM], you agree and are willing to comply [\(Terms of Service\)](#)

SIGN UP

After filling the form click "Create Account"

Account login

Please input your E-mail

Password

SIGN IN

Sign Up | Forgot Password

## Add a Plant

Plant Name

Create Plant

0 Online 0 Warning 0 Fault 0 Total

Create time Efficiency

No Data

Plants Equipment Event Me

Scan the QR code on the dongle while plugged in

ETH - WiFi Stick  
P/N: ESTE-0200-01  
S/N: 1440 038 3220  
C/P: CHC/APP/VNA/VVHR

Ethernet + WiFi Stick (159)

Please put QR Code in the box

Manual input On

Create Plant

SN E#####

Key #####

Plant Information

Plant Name\* TEST

Plant photos

Installed Capacity\* 10 kWp

Operating Date\* 2021-03-25

Installer Sol-Ark

Address\* 5833 Curtis Rd Parker

Time zone\* (UTC-06:00)Central Time (US & Cana...)

Plant Type\* Energy Storage (DC coupling)

Income information

Currency\* \$

On Plant Type, **ALWAYS** select Energy Storage (DC coupling).

Make sure to pick a unique plant name. (I.E. "Last Name, First four of Address")



# Connect the System to the Internet

If Wi-Fi paired with 10.10.10.1, select Done



Congratulations, Created successfully

**DISTRIBUTION NETWORK**

① You can click the confirm button in the upper right corner to complete the creation or to configure the network for the collector

**Select Distribution Network to pair Dongle with WIFI**

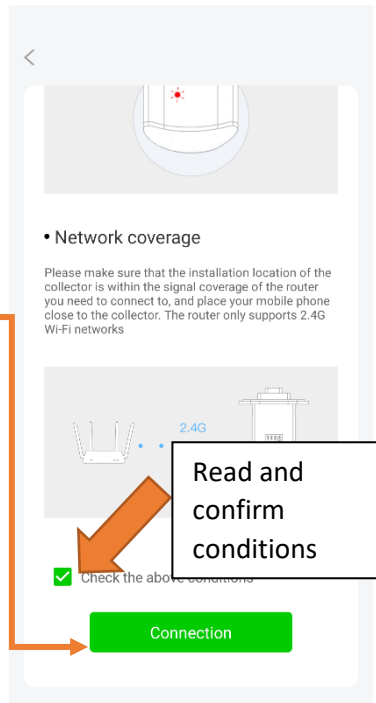

**Read and confirm conditions**

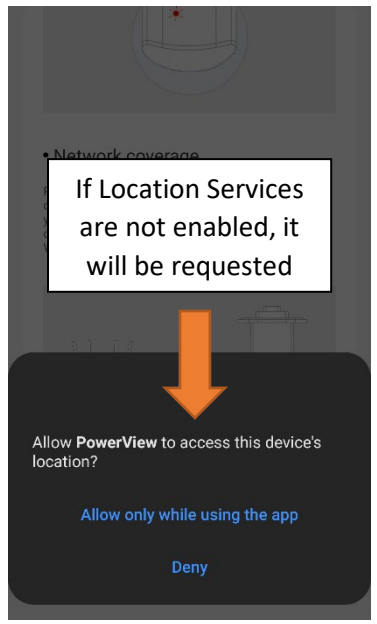

Once you see this screen, go to your **DEVICE'S** Wi-Fi settings and connect to the Wi-Fi network that starts with:

EAP-#####

Password: "12345678"

Return to app once connected

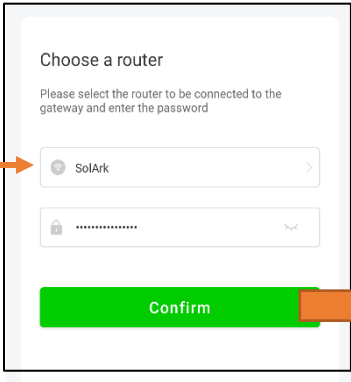

Select the local Wi-Fi network that will be providing the internet connection to the system

**Do NOT select the dongle's Wi-Fi network**

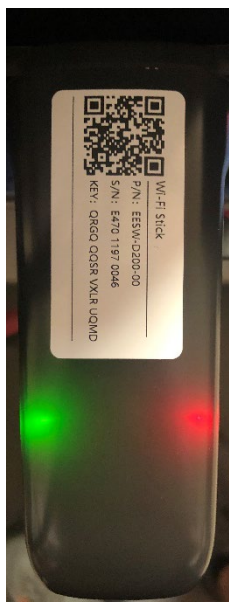
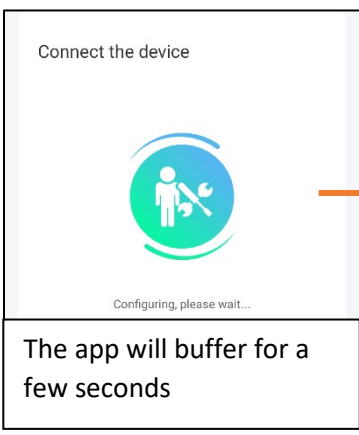

It takes about 60sec for the lights to turn on after setup

**Red LED:** Connected to Sol-Ark and has power

**Green LED:** Connected to Internet and Server

**Flashing Green LED:** Connected to router but not server (usually a VPN or firewall issue)

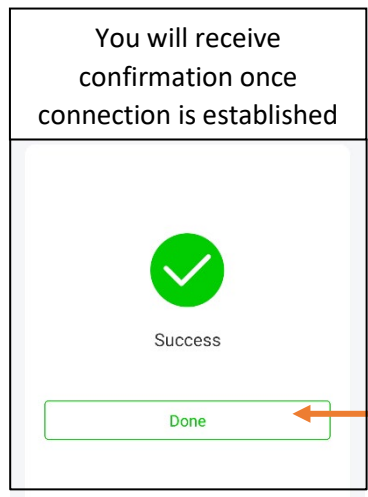

## Start Monitoring The Data

Select your plant

This screen is the real time view

Graphed data

System info and programming

Alarms



### Attention

If you are installing **parallel** systems, **DO NOT** create a plant for each inverter.

Create one plant for the **Master** unit and then use the browser version of PowerView ([mysol-ark.com](http://mysol-ark.com)).

Click on the “...” for the **MASTER’s** plant and hit “Add Gateway” then put the S/N and Key of the **SLAVE’s** dongle.

## IP Address Setup Instructions (PC or Smart Phone)



Please Note that this method only achieves internet connectivity. For registration and account management please use the app and/or [www.mysol-ark.com](http://www.mysol-ark.com)

## Connect to the Dongle Network

- A. Settings → Wi-Fi → Select the Network with EAP- ##### (The last 5 digits of your SN number)

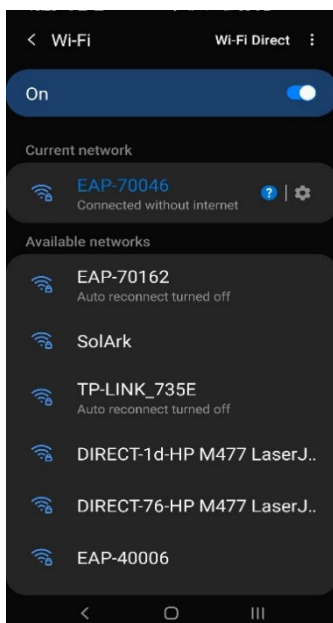

Password: 12345678

**\*Disclaimer\*:** The Wi-Fi dongle does not have internet; You still need to be connected to the dongle for this process.

## Login to Web Portal using ANY Search Browser

- Open Google or Safari → type in the search bar: **10.10.10.1**
- Scroll Down to "Wi-Fi Connection"
- Press "Scan" to search local networks

## Select Your HOME Network

- Find the home network
- Enter personal Wi-Fi Password
- DO NOT SELECT DONGLE NETWORK**
- Select "Connect"

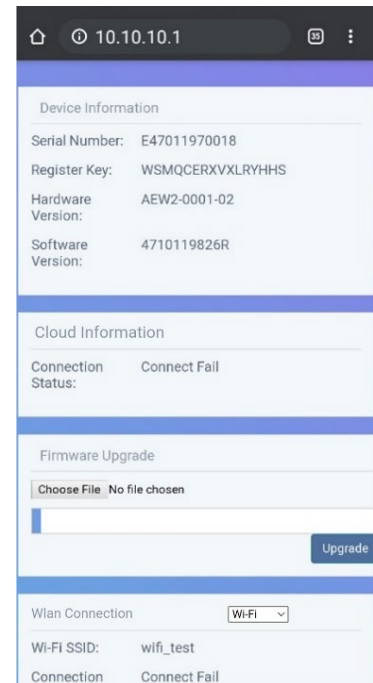
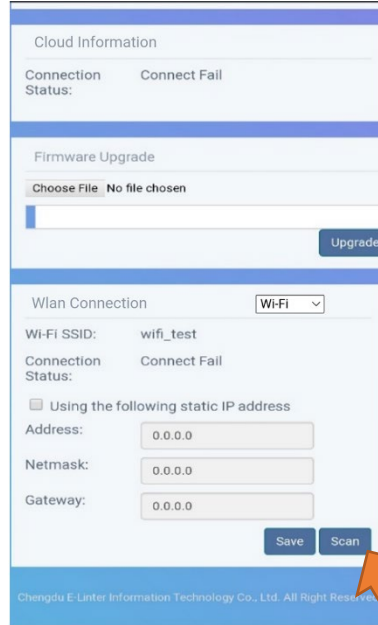

**\*Disclaimer\***

Connecting the dongle via the IP address only connects the dongle to the internet

**\*YOU MUST STILL CREATE AN ACCOUNT VIA THE POWER VIEW APP\***

## Save Your Information

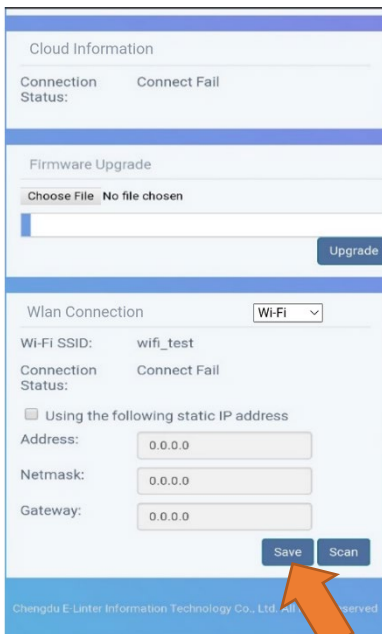

If Successful you should see a Red and Green light on the Dongle showing a successful connection.

**Red LED:** Connected to Sol-Ark and has power.

**Green LED:** Connected to Internet and Server

**Flashing Green LED:** Connected to router but not server (usually a VPN or firewall issue)



## Sol-Ark Menus

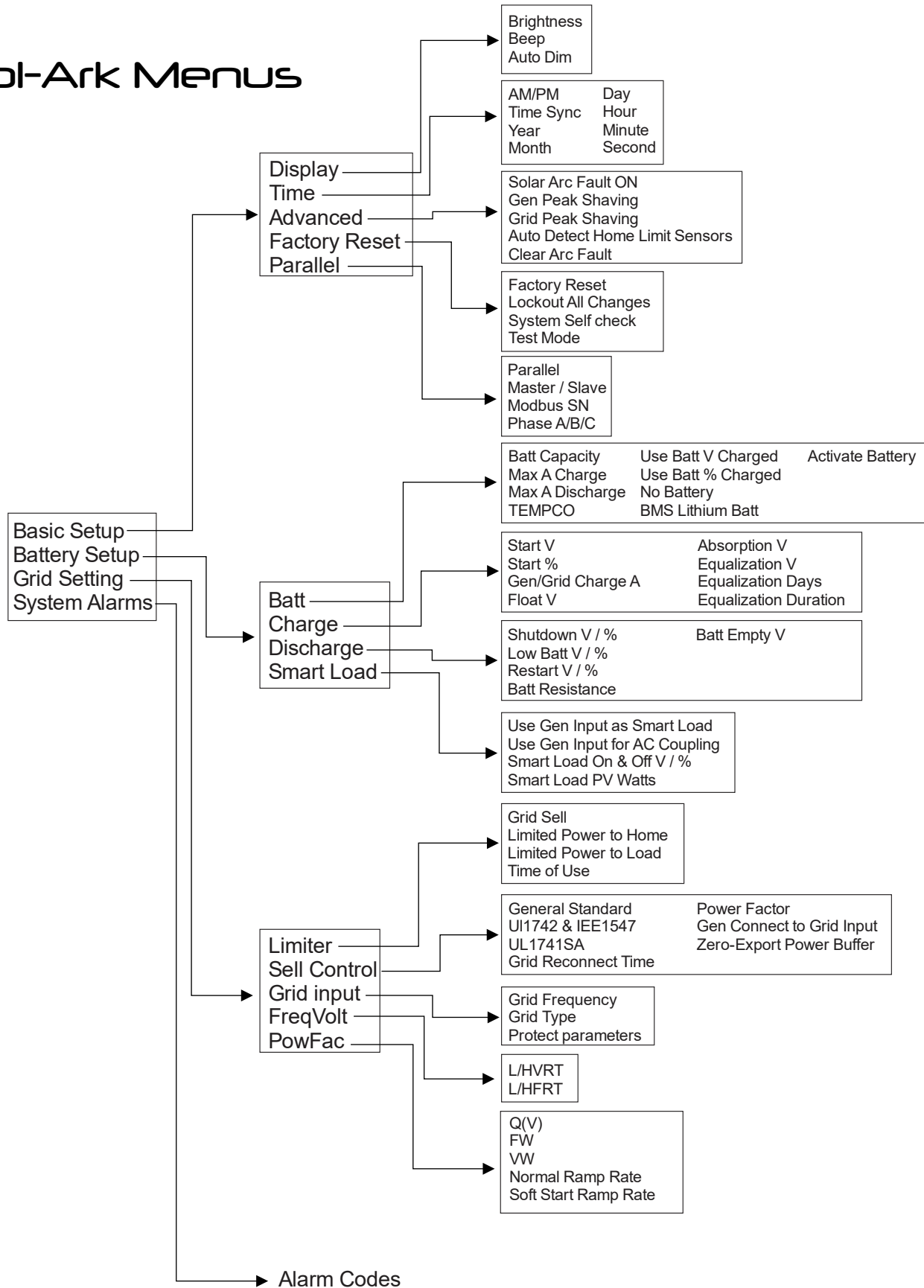

# Main Screens (Touchscreen)

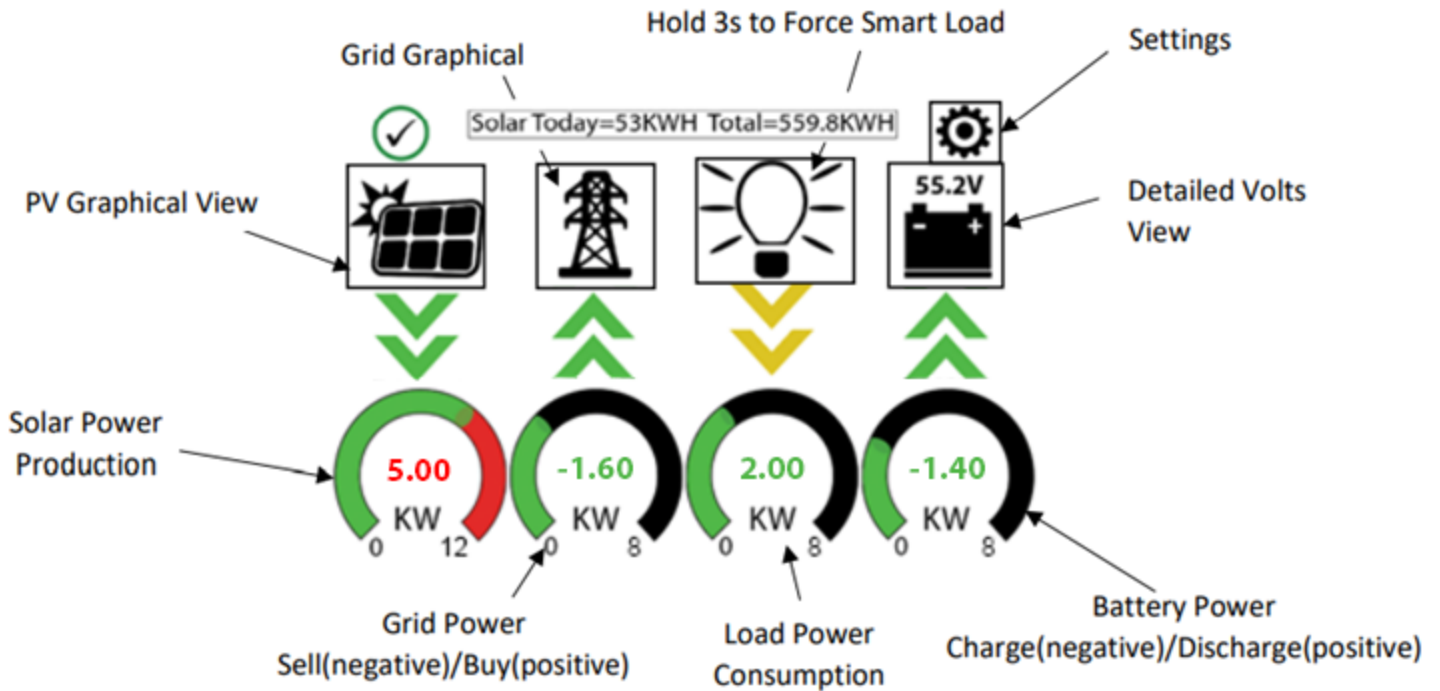

## Detailed Volts View

- Top row = Total power for column
- Middle Row = Line 1/PV1 voltage, Amps, and Watts
  - ⚠ (note: PV Voltage not to exceed 500V)
- Bottom Row = Line 2/PV2 voltage, Amps, and Watts
  - ⚠ (note: PV Voltage not to exceed 500V)
- Batt Temperature will show -20°C if the temperature sensor is not connected. Batt SOC % = % batteries are charged
- DC Temp = Temperature of DC conversion electronics
  - Batt → AC
  - PV → Batt
  - AC → Batt
- AC Temp = Temperature of AC conversion electronics
  - Batt → AC
  - PV → AC
- Grid Column
  - If selling to the Grid, Grid Watts = negative
  - If buying from the Grid, Grid Watts = positive
  - HM = power detected by the external current sensors on the entire home L1 & L2
  - LD = power detected using internal sensors on AC grid in/out breaker

Solar	Grid	INV	USP LD	Batt
3882W	-3081W 60.0Hz	3702W 60.0Hz	621W 122V	-26W
L1: 263V 5.4A	126V HM: -786W	122V 15.2A	0W 121V	54.70V -0.53A
1398W	LD:-1876W	1857W	640W	25.0C
L2: 264V 9.5A	122V HM:1142W	121V 14.8A	<b>Gen</b> 4V 0.0Hz 0W	<b>TEMP</b> DC: 55.0C AC:49.7C
2484W	LD:1205W	1845W		

Note: Reversed Grid Watt values may indicate incorrectly installed current sensors (reversed polarity) See Page 34.

## PV Graphical View

- A. Displays power production over time for the PV array
- B. Use up/down buttons to navigate between days
- C. Month view, Year view, and Total view

## Grid Graphical View

- A. Displays power drawn from and sold to the grid over time
- B. Bars above the line indicate power bought from the grid
- C. Bars below the line indicate power sold back to the grid

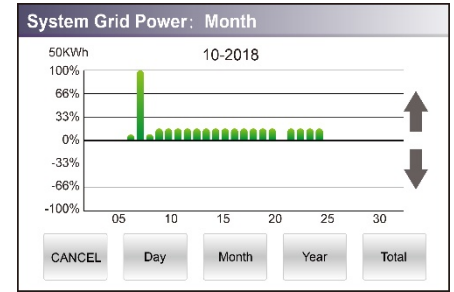

This view can help determine when the peak power is used in the Home and for Time of Use programming

## System Setup Menu

- A. ID = LCD serial #. Support uses the Wi-Fi serial #.
- B. COMM = LCD software version
- C. MCU = Inverter software version

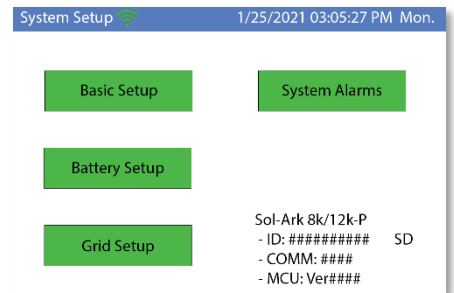

## Basic Setup

### Display

- A. Brightness adjustment
- B. Auto dim (must be enabled for the warranty to cover LCD screen)
- C. Enable/disable BEEP

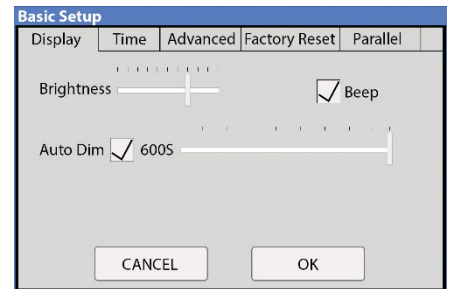

### Time

- A. Set date and time for the system
- B. Alarms & Safety
- C. Arc fault detects if a poor connection in the PV wires

## Grid Peak Shaving

Set the Sol-Ark's threshold to begin contributing power to keep the power drawn from the grid below the threshold.

## Gen Peak Shaving

Set the threshold at which the Sol-Ark will contribute to the generator to prevent large loads overloading the generator.

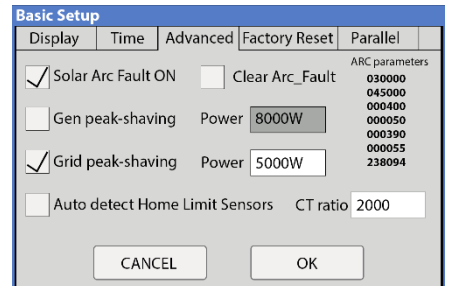

## Parallel (Not needed for 5K model)

- A. Select parallel mode when using more than one system
- B. Set the Master/Slave status of each system
  - i. Label only one system as the "Master"
- C. Set the MODBUS address of each system starting at 01
- D. When using multiple Systems in 120/208V mode, select which phase each system is responsible for (A, B, C)

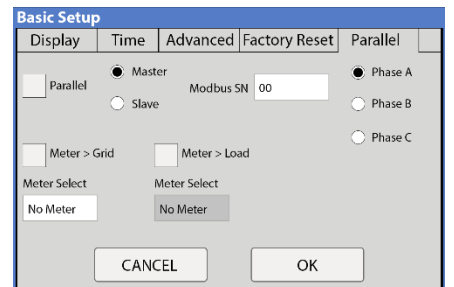

## System Alarms

- A. Lists all recorded System alarms in chronological order

System Alarms		1/25/2021 03:05:27 PM Mon.
Alarms Code	Occurred	
F13	Grid_Mode_changed	2021-01-13 11:22
F13	Grid_Mode_changed	2021-01-13 11:20



# Battery Setup

## Batt

**Batt Capacity:** enter the size of the battery bank connected to the system. Series = add Voltage | Parallel = add Amp-Hours

**Max A Charge:** set the max charge rate for the batteries (This also sets PV → Battery charge rate)



Suggest 20%-30% of battery capacity for lead-acid

**Max A discharge:** set max discharge for battery bank (In off-grid mode, the battery bank will discharge 120% of this value for 10 seconds before the inverter shuts down to prevent battery damage)

**TEMPCO:** Temperature coefficient used in conjunction with the batt temp sensor to adjust optimal voltages for lead-acid batteries

**Use Batt V Charged:** displays battery charge in terms of voltage

**Use Batt % Charged:** Battery voltage can be misleading for determining the % Charged. So, we use algorithms measuring power in and out to measure a true value for % Charged. It compensates for aging batteries also.

## Charge

**Float V:** Set value appropriate for the batteries connected to the system

**Absorption V:** Set value suitable for the batteries connected to the system

- Absorption will stop at 2% of the capacity of the battery bank and drop to float
- Ex: 400Ah battery would be 8A

**Equalization V:** Set value appropriate for the batteries in use.

**Days:** the period between equalization cycles

**Hours:** period taken to equalize batteries



Note if Hours = 0 system will not equalize the batteries

**Gen Charge:** uses the gen input of the system to charge the battery bank from an attached generator.

**Start V:** voltage at which system will AutoStart a connected generator to charge the battery bank

**Start percentage:** Percent S.O.C at which system will AutoStart a corresponding generator to charge the battery bank

**A:** Charge rate from the attached Generator in Amps (DC)



Size this value according to the generator size

**Grid Charge:** uses Grid input to charge batteries from grid or generator

**Gen Exercise Cycle (Day & Time):** Set a weekly Gen exercise schedule. (Day of the week/Time/Duration Length)



Gen must have two-wire start connected to Sol-Ark. To disable the exercise, set the duration length to 0 min.



## Discharge

**Shutdown V:** battery voltage at which the inverter will shut down (battery symbol on the home screen will turn red)

**Low Batt:** Low battery voltage (battery symbol on the home screen will turn yellow)

**Restart:** battery voltage at which AC output will resume

**Batt Resistance:** used in % SOC batt calculations

**Batt Charge Efficiency:** used in % SOC batt calculations

**Batt Empty V:** sets reserve capacity and improves % SOC calculations. It is not Batt\_I adjusted



(Recommendations: 45V for AGMs, 48V for Lithium Iron Phosphate)

Batt Setup				
Batt	Charge	Discharge	Smart Load	
Shutdown	46.0V	20%	Batt Resistance	25mOhms
Low Batt	47.5V	30%	Batt Charge Efficiency	99.0%
Restart	52.0V	40%		
Batt Empty V	47.0V		<input type="checkbox"/> BMS_Err_Stop	
		CANCEL		OK

## Smart Load (Gen Breaker)

- This mode utilizes the Gen input connection as an output that only receives power when the battery exceeds a user-programmable threshold.
- Enable "Use gen input as load output" to power high power loads such as a water heater, irrigation pump, AC unit, pool pump, etc.

### Smart Load OFF Batt

Battery voltage at which the Gen Load will stop receiving power

### Smart Load ON Batt

Battery voltage at which the Gen Load will start receiving power

Batt Setup				
Batt	Charge	Discharge	Smart Load	
<input checked="" type="checkbox"/>	Use gen input as load output		<input type="checkbox"/>	For AC Coupled Input to Gen
<input checked="" type="checkbox"/>	On Grid always on		High Frz	62.00Hz
Smart Load OFF Batt	51.0V	80%	<input type="checkbox"/>	AC couple on load side
Smart Load ON Batt	54.0V	90%		
Solar Power(W)	500W		CANCEL OK	



Using Gen load for a water heater, we recommend that only one leg (120V) be connected to the bottom element. This significantly reduces the power consumption of the water heater while retaining core functionality (it will heat water, only slower).



Gen Load is limited to 50A at 240V (Do not exceed!)

**Solar Watts** is for on Grid

- The system waits to turn on smart load until enough PV power is produced (when on grid)

### AC Coupling Settings (" For AC Coupled Input")

- To use the Gen input breaker as an AC coupled input, check the "For AC Coupled Input" box (this feature will also work with "Grid-Tied" Inverters)
- The meaning of Smart Load OFF Batt and Smart Load ON Batt change in this mode

**Smart Load OFF Batt:** The SOC at which the AC coupled inverter(s) are shut down when in off-grid mode

90% recommended



**Smart Load ON Batt:** The SOC at which the AC coupled inverter(s) are turned on when in off-grid mode

60%-80% recommended



When On-Grid, the AC-coupled inverter will always be on, and the will sell any extra power back to the grid.

**Limited To Home mode will not function with AC coupled PV arrays.**

- C. To use the LOAD breaker for AC coupling grid tied inverter(s)
  - i. You must select "For Micro Inverter Input"
  - ii. The Gen Breaker is not used (even though the GEN breaker is not physically being used for this mode, AC coupling on the LOAD breaker prevents the use of the GEN breaker)
  - iii. Wire as show in the preceding example diagram labeled "Load side AC coupling example"



Some load-side AC coupling installs will require a line side tap instead of the 50A breaker shown in the example diagram

## Grid Setup

### Limiter

**Grid Sell:** maximum watts sold to grid

**Limited To Home:** Limits power produced by the system to match the demand of the Home

**Limited To Load:** Limits power produced by the system to match the demand of connected loads

### Time Of Use:

**Time:** When the System will sell batt/PV power to the Grid or Home

**Power(W):** Max watts called from the battery only at each time

**Batt:** The battery voltage or % at which the system will limit selling to the Grid or Home from the battery. The system will drain the battery until reaching that percent/voltage.

**Charge:** Enables grid/gen charging up to the voltage or percentage specified on the line during a selected period. PV will always charge 100%. If using a generator, select the charge box for the times that may need the generator, and the Gen will charge the battery to the voltage of percentage specified in the "Batt" column.

**Sell:** The sell check box allows the battery to be discharged for grid sell-back for that time slot

Grid Param						
Limiter	Sell Control	Grid Input	FreqVolt	PowFac	Charge	Sell
<input type="checkbox"/> Grid Sell	05000					
		Time	Power(W)	Batt	Charge	Sell
<input type="checkbox"/> Limited Power to Home		01:00AM	2000	50%	<input type="checkbox"/>	<input type="checkbox"/>
<input type="checkbox"/> Limited Power to Load		05:00AM	2000	50%	<input type="checkbox"/>	<input type="checkbox"/>
<input checked="" type="checkbox"/> Limited Power to Load		09:00AM	2000	100%	<input type="checkbox"/>	<input type="checkbox"/>
<input type="checkbox"/> Time of Use	Setup	01:00PM	2000	100%	<input type="checkbox"/>	<input type="checkbox"/>
		05:00PM	2000	50%	<input type="checkbox"/>	<input type="checkbox"/>
		09:00PM	2000	50%	<input type="checkbox"/>	<input type="checkbox"/>
CANCEL		OK				



Note: This Mode requires grid sell / limited to home / peak shaving be enabled.

Note: If you need the batteries to never charge from the grid, **uncheck** the "Grid Charge" box under the charge tab of the battery menu.

## Sell Control

**General Standard:** uses Protect Parameters in table

**UL 1741 & IEEE1547:** Enables sell compliant functionality

**UL1741SA:** Enables wider Freq, Voltage, and Power Factor

**GEN connect to Grid Input:** Enable if Generator connects to the AC Grid breaker

**Zero Export Power:** Power drawn from the grid at all times

Grid Param	
Limiter	Sell Control
<input type="checkbox"/> General Standard	Grid Reconnect Time: 300s
<input type="checkbox"/> UL1741 & IEEE1547	Power Factor: 1.000
<input type="checkbox"/> UL1741SA	<input type="checkbox"/> GEN connect to Grid Input
	Zero Export Power: 20W
	<input type="checkbox"/> Batt First <input type="checkbox"/> Load First
CANCEL    OK	

## Grid Input

**Grid Frequency:** Select the Grid Frequency connection

### Grid Type:

- **220V Single Phase (Call us before using)**
- **120/240V Split Phase (North America)**
- **120/208V 3 Phase**

**Protect Parameters:** (when Settings when the system will connect/disconnect from the grid. UL 1741 & IEEE1547 do not use these parameters.



We recommend widening the frequency range when connecting a generator to the grid breaker (55-65Hz)

Grid Param					
Limiter	Sell Control	Grid Input	FreqVolt	PowFac	Relay
		Grid Frequency <input type="checkbox"/> 50Hz <input type="checkbox"/> 60Hz	Protect Param		
		Grid Type	Grid Vol High	<input type="text" value="228V"/>	
		<input type="checkbox"/> 220V Single Phase	Grid Vol Low	<input type="text" value="185V"/>	
		<input type="checkbox"/> 120/240V Split Phase	Grid Hz High	<input type="text" value="62.0Hz"/>	
		<input type="checkbox"/> 120/208V 3 Phase	Grid Hz Low	<input type="text" value="57.0Hz"/>	
			<input type="button" value="CANCEL"/> <input type="button" value="OK"/>		



If 120/208V, the L1 and L2 are phase specific. So, you may have to swap Grid L1 L2 for 208V applications.  
Inverter power cycle is required each time the input/output voltage is changed

## Selecting Power Mode

Sol-Ark 5K will simultaneously use various power sources available to meet loads demand. The following power modes allow the user to determine the power sources available to the Sol-Ark 5K.

### Limited Load / Self Consumption

- Sol-Ark will only power loads connected to it.
- It will not produce more power than the connected loads require.
- This mode will neither sell back to the Home nor Grid.

### Limited To Home (Zero-Metering)

Main Menu → System Settings → Grid Setup → Limiter → Limited to Home

- Pushes power to the whole Home without selling back any excess to the grid (no net metering agreement required)
- This mode requires the use of the limiter sensors
- Power source priority is the same as Grid Sell Back

### Grid Sell

Main Menu → System Settings → Grid Setup → Limiter → Grid Sell

- This mode allows Sol-Ark 5K to sell back any excess power produced by the solar panels to the grid.

#### Power source priority:

- Solar Panels
- Grid
- Generator (Manual)
- Batteries (until reaching programmable % discharge)

### Time Of Use (using batteries during peak power times)

Main Menu → System Settings → Grid Setup → Limiter → Time Of Use

- Use the batteries to reduce power consumption from the grid during a user programable peak pricing time.

#### Power source priority:

- Solar Panels
- Batteries (programmable % discharge)
- Grid (control when Grid charges)
- Generator

Grid Param						
Limiter	Sell Control	Grid Input	FreqVolt	PowFac	Relay	
<input checked="" type="checkbox"/>	Grid Sell	08000				
			Time	Power(W)	Batt	Charge
<input type="checkbox"/>	Limited Power to Home		01:00AM	2000	49.0V	<input type="checkbox"/>
<input type="checkbox"/>	Limited Power to Load		05:00AM	2000	49.0V	<input type="checkbox"/>
<input type="checkbox"/>			09:00AM	2000	49.0V	<input checked="" type="checkbox"/>
<input type="checkbox"/>			01:00PM	2000	49.0V	<input checked="" type="checkbox"/>
<input checked="" type="checkbox"/>	Time of Use	Setup	05:00PM	2000	49.0V	<input checked="" type="checkbox"/>
<input type="checkbox"/>			09:00PM	2000	49.0V	<input type="checkbox"/>
			<input type="button" value="CANCEL"/> <input type="button" value="OK"/>			

Simultaneously select Grid Sell and Limited to Home

Load (light bulb) icon on the home screen now includes both the load breaker power and the home's consumption.

## FreqVolt (UL 1741SA must be enabled in "Sell Control" tab)

### Puerto Rico Grid Compliance Settings:

Grid Param			
Limiter	Sell Control	Grid Input	FreqVolt
<input checked="" type="checkbox"/> L/HVRT		<input checked="" type="checkbox"/> L/HFRT	
HV2: 288.0V	0.16S	HF2: 61.50Hz	10S
HV1: 264.0V	1S	HF1: 60.50Hz	300S
LV1: 211.2V	2S	LF1: 59.20Hz	300S
LV2: 144.0V	1S	LF2: 57.50Hz	10S
LV3: 108.0V	0.16S		
CANCEL		OK	

### Kauai Grid Compliance Settings:

Grid Param			
Limiter	Sell Control	Grid Input	FreqVolt
<input checked="" type="checkbox"/> L/HVRT		<input checked="" type="checkbox"/> L/HFRT	
HV2: 288.0V	0.16S	HF2: 64.00Hz	0.16S
HV1: 264.0V	5S	HF1: 63.00Hz	20S
LV1: 204.0V	20S	LF1: 57.00Hz	20S
LV2: 120.0V	0.16S	LF2: 56.00Hz	0.16S
LV3: 110.0V	0.16S		
CANCEL		OK	

Grid Param			
Limiter	Sell Control	Grid Input	FreqVolt
<input checked="" type="checkbox"/> Q(V)		<input checked="" type="checkbox"/> FW	<input type="checkbox"/> VW
V1: 225.6V	Q1: 0.44	Fstart: 60.10Hz	Vstart: 254.4V
V2: 232.8V	Q2: 0.00	Fstop: 62.40Hz	Vstop: 264.0V
V3: 247.2V	Q3: 0.00	RT: 0.5s	RT: 10s
V4: 254.4V	Q4: 0.44	Normal Ramp rate	100.0%/s
Response Time	10s	Soft Start Ramp rate	0.3%/s
CANCEL		OK	

### HECO Grid Compliance Settings for O'ahu, Maui, Hawai'i:

Grid Param			
Limiter	Sell Control	Grid Input	FreqVolt
<input checked="" type="checkbox"/> L/HVRT		<input checked="" type="checkbox"/> L/HFRT	
HV2: 288.0V	0.16S	HF2: 64.00Hz	0.16S
HV1: 264.0V	1S	HF1: 63.00Hz	20S
LV1: 211.2V	20S	LF1: 57.00Hz	20S
LV2: 168.0V	10S	LF2: 56.00Hz	0.16S
LV3: 120.0V	0.16S		
CANCEL		OK	

Grid Param			
Limiter	Sell Control	Grid Input	FreqVolt
<input checked="" type="checkbox"/> Q(V)		<input checked="" type="checkbox"/> FW	<input type="checkbox"/> VW
V1: 225.6V	Q1: 0.44	Fstart: 60.10Hz	Vstart: 254.4V
V2: 232.8V	Q2: 0.00	Fstop: 62.40Hz	Vstop: 264.0V
V3: 247.2V	Q3: 0.00	RT: 0.5s	RT: 10s
V4: 254.4V	Q4: 0.44	Normal Ramp rate	100.0%/s
Response Time	10s	Soft Start Ramp rate	0.3%/s
CANCEL		OK	

### HECO Grid Compliance Settings for Lana'i and Moloka'i:

Grid Param			
Limiter	Sell Control	Grid Input	FreqVolt
<input checked="" type="checkbox"/> L/HVRT		<input checked="" type="checkbox"/> L/HFRT	
HV2: 288.0V	0.16S	HF2: 65.00Hz	0.16S
HV1: 264.0V	1S	HF1: 63.00Hz	20S
LV1: 211.2V	20S	LF1: 57.00Hz	20S
LV2: 168.0V	10S	LF2: 56.00Hz	0.16S
LV3: 120.0V	0.16S		
CANCEL		OK	

Grid Param			
Limiter	Sell Control	Grid Input	FreqVolt
<input checked="" type="checkbox"/> Q(V)		<input checked="" type="checkbox"/> FW	<input type="checkbox"/> VW
V1: 225.6V	Q1: 0.44	Fstart: 60.10Hz	Vstart: 254.4V
V2: 232.8V	Q2: 0.00	Fstop: 62.40Hz	Vstop: 264.0V
V3: 247.2V	Q3: 0.00	RT: 0.5s	RT: 10s
V4: 254.4V	Q4: 0.44	Normal Ramp rate	100.0%/s
Response Time	10s	Soft Start Ramp rate	0.3%/s
CANCEL		OK	

### PowFac

Power Factor is programmable from 0.8 – 1.0

# Limiter Sensor Automatic Setup

Requires Batteries, AC coupled panels must be off while detecting, and does NOT work for 208V installs.

If you do not have batteries or are in 208V mode: verify CT sensor placement manually.

- Install limiter sensors as previously described (shown in all diagrams as well). Battery and grid connections also required before starting auto-setup.
- Navigate to the "Advanced" Tab of the Basic Setup screen (follow the directions below to get there)
  - Touch the gear icon → Touch the Basic Setup button → Select the Advanced tab (see Fig. C)
- Select "Auto detect Home Limit Sensors" and press "OK"
- Wait for the Sol-Ark to finish its learning process (Sol-Ark will alternate sell back between legs and magnitude automatically determining the correct settings for the sensors)
- Verify sensors were correctly configured (see Fig. D) if they are not correct, repeat the learn function

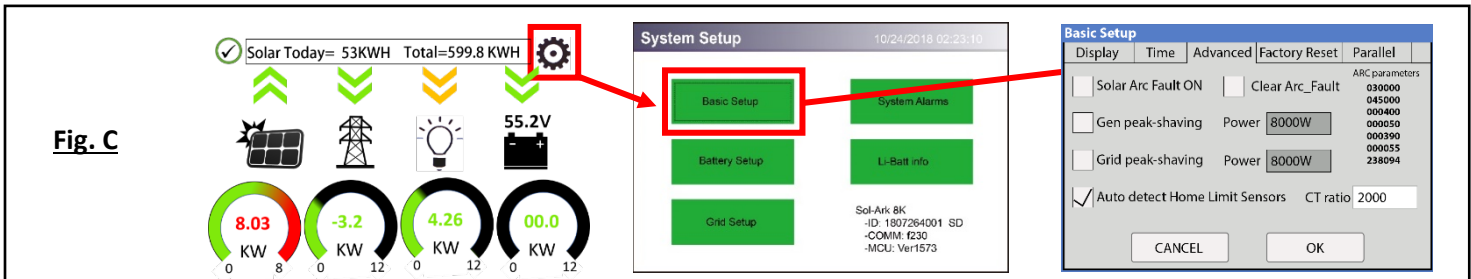

Fig. C

**Fig. D**

In Limited To Home Mode HM values will be close to zero. HM values should never be negative. If negative, the Limiter Sensors are not installed properly.

	Solar	Grid	INV	USP LD	Batt
	3882W	-3081W	3702W	621W	-26W
		60.0Hz	60.0Hz	122V	
L1: 263V		126V	122V	0W	54.70V
5.4A		HM: -786W	122V	121V	-0.53A
1398W		LD:-1876W	1857W	640W	25.0C
L2: 264V		122V	121V	Gen	TEMP
9.5A		HM:1142W	14.8A	4V	DC: 55.0C
2484W		LD:1205W	1845W	0.0Hz	AC:49.7C
				0W	

**Possible Limiter Sensor issues:**

- Sensors are facing wrong direction
- Sensors are on the wrong wire(s)
- Sensors are not fully closed on wire(s)
- Sensor Polarity is wrong (White = + BLK = -)



### Verifying proper sensor direction:

- Any loads in the home will show a positive HM (+) value in Watts
- Turning on solar panels and enabling Grid Sell should show a negative HM (-) in Watts if you are producing more power than the loads are consuming
- If you turn on limited power to Home mode, then HM: ~0 Watts to zero the meter (system matches the loads to within 99%)



If you installed limiter sensors (CTs) for Limited To Home selling mode, verifying the proper sensor placement and direction is critical. Remove one sensor from the main L1 connection, and the power should drop to 0W.

## Off-Grid Install Tips

Sol-Ark 5K will automatically operate in Off-Grid Mode without the grid (under the same power priority as TOU).

- A. Limiter Sensors are not required for completely Off-Grid installs unless using Grid Peak Shaving with a Gen connected to Grid input breaker.
- B. The Grid input breaker on the Sol-Ark should be used as the Generator input (4-30kW generators) so that you maintain Smart Load output capability when off-grid. Smart Load will allow you to run high-power non-essential appliances (hot water, dehumidifier, heat pump, irrigation pump) on solar power instead of batteries. Therefore, you will use Grid Charge (default) in the Battery Setup/Charge menu.
- C. When off-grid, there is no need for a transfer switch: connect the load output of the Sol-Ark to the whole home.
- D. Do not use Grid Sell or Limited To Home Modes. Only Limited power to load (default).
- E. The Auto Generator start functions as a 2-wire switch (closes the circuit when needing charging)
  - i. Auto Gen-start will be triggered when the battery voltage or percent reaches the level programmed in the battery setup menu. Then, the generator will continue to charge the batteries until they are about 95% full (this percentage is not programmable) before turning the generator off.
  - ii. When using the Sol-Ark to control a generator, an exercise function will turn on the generator once a week on Monday mornings at 8 AM

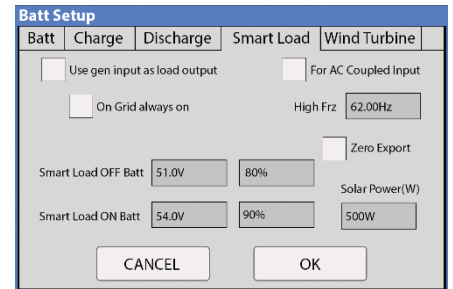

- F. We recommend changing the "Grid Reconnect Time" under the Sell control tab of the grid setup menu to 30 seconds; otherwise, the Sol-Ark will not charge from the generator until it has been on for at least 5 minutes per the default value of 300 seconds.
- G. Under setup for Grid/Sell Control, select General Standard and "GEN connect to Grid Input." Then go to Grid input to widen the input frequency range to 55-65Hz to work with any frequency generator.
- H. If you would like to use a wind turbine in conjunction with the Sol-Ark 5K, the turbine must have a 48V charge controller with a dump load to prevent overcharging the batteries. Connect the charge controller on the turbine to the battery bank the Sol-Ark is using, and the turbine will help charge the batteries.

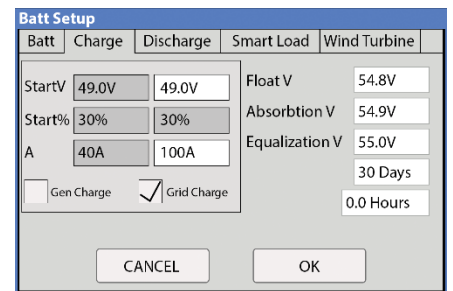

- I. Don't forget to set the Battery capacity and reasonable charge rates.

## Grid-Tie / No Battery Install Tips

- A. Under Battery setup, select no Battery & disable Activate Battery (or system will beep).
- B. Note: a whole system power cycle may be required when changing the battery to no battery settings.
- C. Under Grid Setup, select Grid Sell.
- D. Touch Battery Icon to see the Detailed Volts View to verify your inputs & outputs.

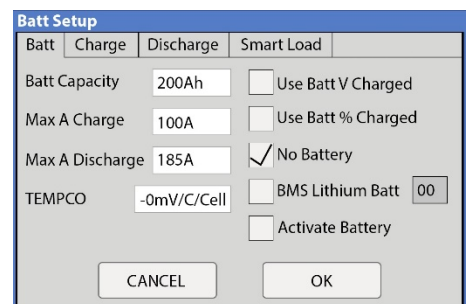

Solar	Grid	INV	USP LD	Batt
3882W	-3081W 60.0Hz	3702W 60.0Hz	621W 122V	-26W
L1: 263V 5.4A	126V HM: -786W	122V 15.2A	0W 121V	54.70V -0.53A
1398W	LD: -1876W	1857W	640W	25.0C
L2: 264V 9.5A	122V HM: 1142W	121V 14.8A	<b>Gen</b> 4V 0.0Hz	<b>TEMP</b> DC: 55.0C AC: 49.7C
2484W	LD: 1205W	1845W	0W	



## Battery Charging Information

### 4-Stage Charging

The MPPT has a 4-stage battery charging algorithm for rapid, efficient, and safe battery charging. The figure below shows the stage sequence.

#### Bulk Charge Stage

In the Bulk Charge stage, the battery is not at a 100% state of charge and has not yet reached the Absorption voltage setpoint. The controller will deliver 100% of available solar power to recharge the battery.

#### Absorption Stage

When the battery has reached the absorption voltage setpoint, we use constant-voltage regulation to maintain battery voltage at the absorption setpoint, preventing heating and excessive battery gassing. The battery is allowed to come to a full state of charge at the absorption voltage setpoint. Absorption lasts until batteries charge at 2% of the programmed Ah size.

#### Float Stage

After the Absorption stage charges the battery fully, the MPPT reduces the battery voltage to the float voltage setpoint. If batts have 100% charge, there can be no more chemical reactions, and all the charging current turns into heat and gassing. The float stage provides a meager rate of maintenance charging while reducing the heating and gassing of a fully charged battery. The purpose of float is to protect the battery from long-term overcharge.

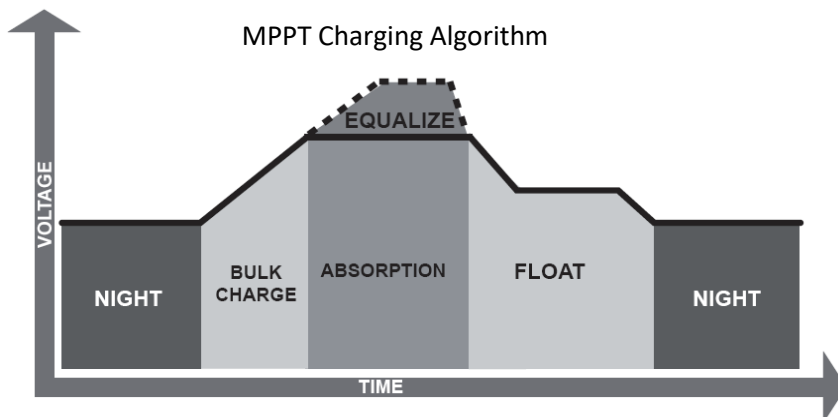

### Battery Charging Setpoint Examples (48V)

Battery Type	Absorption Stage	Float Stage	Equalize Stage (every 30 days 3hr)
AGM / PCC	14.4v ( <b>57.6v</b> )	13.5v ( <b>53.6v</b> )	14.4v ( <b>57.6v</b> )
Gel	14.1v ( <b>56.4v</b> )	13.5v ( <b>54.0v</b> )	
Wet	14.7v ( <b>59.0v</b> )	13.7v ( <b>55.0v</b> )	14.7v ( <b>59.0v</b> )
Lithium	14.1v ( <b>54.6v</b> )	13.2v ( <b>54.3v</b> )	14.1v ( <b>54.6v</b> )

Default



- Batteries in series: **ADD VOLTAGES**
- Batteries in parallel: **ADD AMP-HOURS**

### Calculating Battery Bank's Amp-Hours (PCC 230)

Battery Count	Voltage / Battery	Amp Hours / Battery	Total Amp Hours @48V	Max Charge/ Discharge Amp
4	12V	230Ah	230Ah	100A
8	12V	230Ah	460Ah	185A
12	12V	230Ah	690Ah	185A
16	12V	230Ah	920Ah	185A



### **Sol-Ark PCC-230 Battery**

Batt Capacity: 230Ah x #Parallel\_Batteries  
(1 parallel = 4 Batt in series, 2 = 8 Batt, 3 = 12 Batt, 4 =16 Batt)  
Max A Charge: 100A x #Parallel\_Batteries  
Max A Discharge: 100A x #Parallel\_Batteries  
Max A Grid Charge: 50A x #Parallel\_Batteries  
TEMPCO: -5mV/C/Cell  
Float V: 53.6V  
Absorption V: 57.6V  
Equalization V: 57.6V  
Equalization Days: 30  
Equalization Duration: 3 Hours  
Recommended Shutdown V / Percentage: 47.0V & 20%  
Recommended Low Batt V / Percentage: 47.5V & 35%  
Recommended Restart V / Percentage: 52.0V & 50%  
Battery Resistance: 35mOhms (8 Batt) or 25mOhms (16 Batt)  
Battery Charge Efficiency: 99%  
Battery Empty Voltage: 45V

Time	Watts	SOC	GridCharge
1:00AM	1500*Par_Batts	70%	
5:00AM	1500*Par_Batts	70%	
9:00AM	1500*Par_Batts	70%	
1:00PM	1500*Par_Batts	100%	
4:00PM	1500*Par_Batts	70%	
9:00PM	1500*Par_Batts	70%	

These settings will charge the batteries off solar only.  
Discharge the batteries down to a maximum of 70% full.

Limited To Home mode will not sell to the grid from the batteries (only the home will use battery power). The 100% time slot is to ensure that the batteries are properly cycled each day.

### **Generation 2 Fortress Battery-eVault18.5**

Batt Capacity: 360Ah x #Parallel\_Batteries  
Max A Charge: 150A (100A for life) x #Parallel\_Batteries  
Max A Discharge: 160A x #Parallel\_Batteries  
Max A Grid Charge: 100A x #Parallel\_Batteries  
TEMPCO: 0mV/C/Cell  
BMS Lithium Batt: 04  
Float V: 54.4V  
Absorption V: 54.4V  
Equalization V: 55.5V  
Equalization Days: 30  
Equalization Duration: 1 Hours (tops off battery)  
Recommended Shutdown V / Percentage: 51.3V & 20%  
Recommended Low Batt V / Percentage: 51.7V & 30%  
Recommended Restart V / Percentage: 51.9V & 40%  
Battery Resistance: 5mOhms  
Battery Charge Efficiency: 99%  
Battery Empty Voltage: 47V

Time	Watts	SOC	GridCharge
1:00AM	6000*Par_Batts	40%	
5:00AM	6000*Par_Batts	40%	
9:00AM	6000*Par_Batts	40%	
1:00PM	6000*Par_Batts	40%	
5:00PM	6000*Par_Batts	40%	
9:00PM	6000*Par_Batts	40%	

These settings will charge the batteries off solar only.  
Discharge the batteries down to a maximum of 40% full.

Limited To Home mode will not sell to the grid from the batteries (only the home will use battery power).

### **Simpliphi Power: PHI 3.8 Battery 48V**

Batt Capacity: 75Ah x # Batt  
Max A Charge: 37.5A x # Batt (20A for better lifespan)  
Max A Discharge: 37.5A x # Batt (34A for better lifespan)  
Max A Grid Charge: 20A x # Batt  
TEMPCO: 0mV/C/Cell  
BMS Lithium Batt: Not Selected  
Float V: 54.0V  
Absorption V: 56V  
Equalization V: 56V  
Equalization Days: 30  
Equalization Duration: 2 Hours (tops off battery)  
Recommended Shutdown V / Percentage: 50.2V & 20%  
Recommended Low Batt V / Percentage: 50.6V & 30%  
Recommended Restart V / Percentage: 51.0V & 40%  
Battery Resistance: 24mOhms ÷ (battery Count)  
Battery Charge Efficiency: 99%  
Battery Empty Voltage: 48V

Time	Watts	SOC	GridCharge
1:00AM	1000*Batts	40%	
5:00AM	1000*Batts	40%	
9:00AM	1000*Batts	40%	
1:00PM	1000*Batts	40%	
5:00PM	1000*Batts	40%	
9:00PM	1000*Batts	40%	

These settings will charge the batteries off solar only.  
Discharge the batteries down to a maximum of 40% full.

Limited To Home mode will not sell to the grid from the batteries (only the home will use battery power).

**Blue Ion 2.0 Battery**

Batt Capacity: 40Ah x #Parallel\_Batteries  
 (4 Parallel = 160Ah, 6 = 240Ah, 8 = 320Ah)  
 Max A Charge: 160A w/ 4 Batteries, 185A w/ 6+  
 Max A Discharge: 160A w/ 4 Batteries, 185A w/ 6+  
 Max A Grid Charge: 160A w/ 4 Batteries, 185A w/ 6+  
 TEMPCO: 0mV/C/Cell  
 BMS Lithium Batt: 03 (eGauge) / 00 (Namaka Box)  
 Float V: 55.2V  
 Absorption V: 55.2V  
 Equalization V: 55.2V  
 Equalization Days: 30  
 Equalization Duration: 1 Hours (tops off battery)  
 Recommended Shutdown V / Percentage: 47.0V & 20%  
 Recommended Low Batt V / Percentage: 49.0V & 30%  
 Recommended Restart V / Percentage: 52.0V & 40%  
 Battery Resistance: 5mOhms  
 Battery Charge Efficiency: 99%  
 Battery Empty Voltage: 46V

Time	Watts	SOC	GridCharge
1:00AM	8000*Par_Batts	40%	
5:00AM	8000*Par_Batts	40%	
9:00AM	8000*Par_Batts	40%	
1:00PM	8000*Par_Batts	40%	
4:00PM	8000*Par_Batts	40%	
9:00PM	8000*Par_Batts	40%	

These settings will charge the batteries off solar only. Discharge the batteries down to a maximum of 40% full.

Limited To Home mode will not sell to the grid from the batteries (only the home will use battery power). The 100% time slot is to ensure that the batteries are properly cycled each day.

**Dyness B4850 Battery Module**

Batt Capacity: 50Ah x #Parallel\_Batteries  
 Max A Charge: 50A (25A for life) x #Parallel\_Batteries  
 Max A Discharge: 50A x #Parallel\_Batteries  
 Max A Grid Charge: 50A x #Parallel\_Batteries  
 TEMPCO: 0mV/C/Cell  
 BMS Lithium Batt: 01  
 Float V: 53.8V  
 Absorption V: 54.0V  
 Equalization V: 54.0V  
 Equalization Days: 30  
 Equalization Duration: 1 Hours (tops off battery)  
 Recommended Shutdown V / Percentage: 47V & 20%  
 Recommended Low Batt V / Percentage: 48V & 30%  
 Recommended Restart V / Percentage: 49V & 40%  
 Battery Resistance: 5mOhms  
 Battery Charge Efficiency: 99%  
 Battery Empty Voltage: 46V

Time	Watts	SOC	GridCharge
1:00AM	2400*Par_Batts	40%	
5:00AM	2400*Par_Batts	40%	
9:00AM	2400*Par_Batts	40%	
1:00PM	2400*Par_Batts	40%	
5:00PM	2400*Par_Batts	40%	
9:00PM	2400*Par_Batts	40%	

These settings will charge the batteries off solar only. Discharge the batteries down to a maximum of 40% full.

Limited To Home mode will not sell to the grid from the batteries (only the home will use battery power).

**MODBUS/RJ45 Application Note**

**Use the information below at your own risk; the warranty will not cover any damage caused by the improper use of the communications protocols.** Read-Only Modbus Map available upon request at [support@sol-ark.com](mailto:support@sol-ark.com)

**MODBUS**  
 Pin 1 or 8 is RS485-B (Data -)  
 Pin 2 or 7 is RS485-A (Data +)  
 Pin 3 or 6 is GND  
 Baud 9600  
 8bits data  
 One stop bit, no parity  
 Does not require termination

**CANBUS**  
 Pin 2 is Ground  
 Pin 4 is CAN High  
 Pin 5 is CAN Low

- If you set Lithium batt = 03, I.E., Blue Ion and EGauge (MODBUS)
- If you set Lithium batt = 02, N/A
- If you set Lithium batt = 01, you get a response for batt communication.
- If you set Lithium batt = 00, the inverter is a slave, and the external device is the Master. I.E., Discover Lynk (CANBUS)



Find our full list of currently supported battery communications at [www.sol-ark.com/support](http://www.sol-ark.com/support).

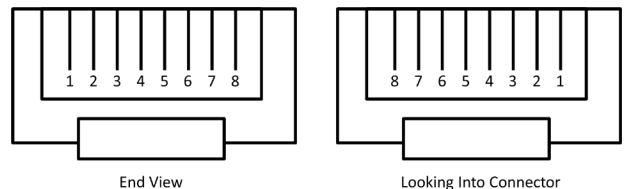

## LCD is not powering on

- Check all connections- at least one of the following power sources is required: PV/Grid/Battery
- Try pressing the power button, touchscreen, or navigation buttons

## Panels are connected, but DC Light is not on

- PV voltage must be 150V-425V | It's night

## Panels are not producing

- Check for proper wiring on all solar panel connections
- Turn PV disconnect "ON"
- Check that the PV input voltage is not greater than 425V
- If the system says PV = 0V, check PV polarity

## Panels are not producing much power

- PV Wire Strip Length: 5/8". Your batteries are charged; you can test Grid Sell to verify.

## The system does not keep batteries charged

- Check the charge setting in the Charge Menu

## Auto Gen-Start not working

- Check to make sure your generator is compatible with Auto Start
- Make sure that the Auto Gen Start wire is adequately connected to the Sol-Ark 5K and the generator

## Normal LED isn't on

- Sol-Ark 5K is in pass-through-only mode, only a Grid connection.
- Sol-Ark 5K is not working correctly (Call us)

## The alarm light is on

- Check the system alarms menu to identify the alarm

## Grid HM value is negative when it should be positive (only applies in limited home mode)

- Limiter Sensors are backward, L1/L2 sensors are swapped, or incorrectly wired L1/L2 sensors. Try Auto Learn.

## AC Overload Fault or Bus Unbalance Fault

- Check Transfer Switch/Subpanel wiring
- Check for large loads that consume more than the inverter rating (EX: AC units over 3 tons)

## The system connects to grid and quickly disconnects

- With a DMM, verify your Neutral wire connection (should be 0 Vac referenced to GND)
- Check your Freq is set to 60Hz, and the 5K measures 120V on L1 / L2 vs. N.
- If overloading: verify 120/240V grid input and load output wires are not swapped.
- If 120/208V, the L1 and L2 are phase-specific. So, you may have to swap Grid L1 / L2 for 208V applications.

## DC Overload Fault

- Check PV voltage
- Make sure you have not wired more than two (2) solar strings in parallel

## System is beeping

- Check the system alarms menu to see which alarm has been triggered. Most alarms will self-reset.
- There is no battery connected. If not using a battery, select no battery and disable activate batt in Batt menu.
  - Turn off the center button, remove AC Grid and PV Power for the 30s (screen is dead), and then power up to fully reset the system.

### Battery cable sparks when connected

- Put the built-in battery breaker in the off position before connecting or disconnecting batteries.

### Battery symbol on the home screen is red

- The battery is under-Voltage or over-Voltage

### Battery symbol on the home screen is yellow

- The battery is low, or the charge/discharge current is close to the programmed limit (which is ok)

### Grid symbol on the home screen is yellow

- Grid parameters are out of specified range or grid is down

### System has restarted

- It happens if the system is overloaded, battery voltage is greater than 63V, or Software update

### Batteries were connected backward

- The battery breaker will trip. It can cause damage!

### Why is the LCD screen still on when the power button is off?

- If PV or Grid power, LCD stays on, but the inverter and loads are off.

### The Batt % meter is not reaching 100%

- The system needs to go through a small discharge/charge cycle first to calibrate the battery

### Generator setup is reading 0Hz

- Select "General Standard" instead of UL1741. Then widen the frequency range to 55Hz-65Hz.

### Color Touchscreen is Frozen

- Press and hold the escape button [←] for 7-10 seconds

## Troubleshooting Phasing Issues

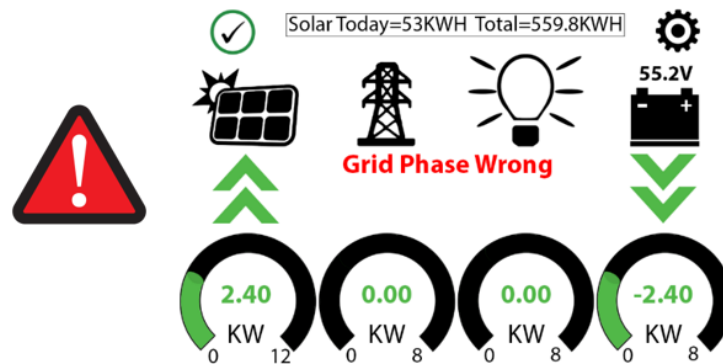

If the Sol-Ark screen shows the above error, there is a phasing issue with your wiring, and it may cause overload faults (F18, F26, F34) even with the Load breaker **off** and **WILL CAUSE DAMAGE if left unchecked**.

Single Sol-Ark: To locate the improperly wired phases, measure **L1 to L1 (Top Screws)** between the **Grid** and **Load** breaker; you should see 0V AC. Repeat for **L2 to L2** between the **Grid** and **Load** breaker. Attempt to correct the wiring until you are only reading 0V AC between **L1 to L1** & **L2 to L2**.

Parallel inverters: measure L1 of the **Grid** breaker to L1 of another unit's **Grid** breaker; you should see 0V AC. If in 208V parallel, measure the lines of the same wire color between sol-arks to see if you read 0V AC.

Make sure to correct both the Grid and Load wiring; they both need to be correct.

If the error persists, you will need to check your AC wiring beyond the inverter and may also need to verify that the phases are properly labeled coming from your meter.

## Sol-Ark 5K Error Codes

Fault	Instruction	Common Cause/Remedy
F1	DC Inversed Failure	If you have parallel systems and turn one system off, you will get this notification. Not a fault.
F8	GFDI_Relay_Failure	Current Leakage from inverter AC output to Ground, check Ground and neutral are connected at the main panel
F13	Grid_Mode_change	It can happen when not using batteries or if Grid Input settings are changed. This is a notification, NOT a fault. If you switch from No Batt to Battery mode, Power the System down completely to restart.
F15	AC_OverCurr_Failure	It is usually caused by Loads too large for the inverter. If off-grid, the battery discharge amps are programmed too low. Overloads can result in F15, F18, F20, or F26.
F16	GFCI_Failure	Ground fault. Check PV+ or PV- wiring (which must be ungrounded). Exposed PV conductors + rain can also cause. Check that the neutral line and Ground are not double-bonded (common with portable generators).
F18	Tz_Ac_OverCurr_Fault	Overloaded the Load Output: reduce loads. Wiring Short on the AC Side can also cause this error. Overloads can result in F15, F18, F20, or F26.
F20	Tz_Dc_OverCurr_Fault	It is typically caused by DC current from the battery that is too large (ex: 4 Ton AC Unit). Overloads can result in F15, F18, F20, or F26.
F22	Tz_EmergStop_Fault	Initiated Emergency Stop; see sensor pinout table.
F23	Tz_GFCI_OC_Fault	PV Ground fault. Check PV+ or PV- wiring (which must be ungrounded or damage can occur). Typically caused by pinched PV wire grounding the PV+ or PV-. Grounded PV wire can cause F20, F23, or F26.
F24	DC_Insulation_Fault	An exposed PV conductor combined with moisture is faulting (can cause F16, F24, F26).
F25	AC_Active_Batt_Fault	No battery connection to the Inverter and Activate Battery is enabled. Disable Activate Battery in settings while no battery is connected.
F26	BusUnbalance_Fault	Too much load on one leg (L1 or L2) Vs. the other leg or DC loads on the AC output when off-grid. Grounded PV wire can cause F20, F23, or F26.
F29	Parallel_CANBus_Fault	Usually, a communication error for parallel systems, check cables and MODBUS addresses
F30	AC_MainContactor_Fault	Contact Sol-Ark.com
F31	Soft_Start_Failed	Soft Start of large motor failed
F34	AC Overload Fault	AC Overload or load shorted. Reduce heavy loads.
F35	AC_NoUtility_Fault	Grid connection lost
F37	DCLLC_Soft_Over_Cur	Software DC overcurrent
F39	DCLLC_Over_Current	Hardware DC overcurrent
F40	Batt_Over_Current	Batteries exceeded their current discharge limit
F41	Parallel_System_Stop	If one system faults in parallel, this normal fault will register on the other units as they disconnect from grid
F45	AC_UV_OverVolt_Fault	Grid under voltage causes a disconnect. This will self-reset when grid stabilizes.
F46	Parallel_Aux_Fault	Cannot communicate with other parallel systems. Check Master = 1, Slaves are 2-9, ethernet cables are connected.
F47	AC_OverFreq_Fault	Grid over Frequency (common in power outages) causes a disconnect. Will self-reset when grid stabilizes.
F48	AC_UnderFreq_Fault	Grid under Frequency (common in power outages) causes a disconnect. Will self-reset when grid stabilizes.
F55	DC_VoltHigh_Fault	PV may be higher than 500V. Battery voltage should not be above 59V or 63V (depending on the model).
F56	DC_VoltLow_Fault	Batteries are overly-discharged, or Lithium BMS has shut down. If battery settings are off, this can also happen.
F58	BMS communication fault	Sol-Ark is programmed to BMS Lithium Battery Mode but cannot communicate with a BMS
F60	Gen_Volt_or_Fre_Fault	Generator Voltage or Frequency went outside the allowable range
F61	Button_Manual_OFF	The parallel Slave system turned off without turning off Master
F63	ARC_Fault	It can be a lousy PV connector/connection. And sometimes a false alarm due to powerful lightning storms.
F64	Heatsink_HighTemp_Fault	Check the built-in fans are running; ambient temp may be too high

**For installer to complete AFTER the system is operational. The purpose is to protect the installer, homeowner, and inverter.**

1. Is the 5K installed in a location where the **LCD is protected from direct sunlight** and has 6" clearance left and right for cooling (12" between parallel systems)? **Y/N**
2. Are all the battery lugs tightened? **Y/N**
3. 5K should connect to grid, 5K 63A load/Grid breakers ON, batteries connected, PV input on and ON button on. With the inverter running the Backup load's panel and Grid-connected:
  - A. Did any breakers trip? **Y/N**
  - B. Did inverter overload? **Y/N**
4. If you have problems, please take pictures of these and email to: support@ Sol-Ark.com
  - A. **Battery icon screen, showing detailed voltages (the screen shown below)**
  - B. **Sol-Ark 5K with batteries and of user wiring area**
5. Load and solar test
  - A. Press the battery icon for the detailed voltages screen.
  - B. Is batt temp sensor working? **Y/N**
  - C. Turn on many loads for the Backup circuits. Are solar panels producing enough power to match the load (provided there is enough sun)? **Y/N**
  - D. Program Full Grid Sell Mode. If there are enough panels and sun or light loads in the entire house, the Grid HM measurements will be negative on both L1/L2. Are they negative (solar selling back to grid)? **Y/N**
  - E. Program limited power to home mode. The Grid HM sensors will be near zero or slightly positive. Are they both near zero and canceling out the whole home power? **Y/N**
  - F. You have verified the limit sensors are correctly installed. An auto-learn function corrects any mistakes in CT limiter wiring (provided you have batteries and in 120/240V). Program in the correct Grid mode the customer will use.
6. Did you program the correct Ah for the battery bank and max Amps charge/discharge? **Y/N**
7. Did you program the correct battery charge voltages for your battery type? **Y/N**
8. **Turn off the AC breaker, so 5K is operating in an off-grid mode for several minutes.** Are appliances still powered? **Y/N**
9. **Turn off PV input, running only on batteries for several minutes.** Are appliances still powered? **Y/N**
10. Turn on PV input and AC Grid inputs.
11. Did you set up the Wi-Fi plug to the customer's internet? **Y/N**
12. Absolutely important for software updates. Did you help the customer register system on Monitoring App? **Y/N**
13. Does the customer have a standby generator or a small portable Generator? **Y/N**
  - A. Did you turn off UL1741/IEEE1547 (use General Standard) and reprogram grid freq. range to 55-65Hz? **Y/N**
  - B. Did you enable Gen charging and adequately set the charge current if using a small gas generator on Gen inputs? **Y/N**
14. If EMP protected, did you install EMP Suppressors on essential appliance cords? **Y/N**



**This checklist must be filled out and submitted to register your warranty. Please visit:**

**<https://www.sol-ark.com/register-your-sol-ark/>**

\_\_\_\_\_  
Installer Name

\_\_\_\_\_  
Installer Signature

\_\_\_\_\_  
Date

\_\_\_\_\_  
Customer Name

\_\_\_\_\_  
Customer Signature

\_\_\_\_\_  
Date

5-Year Limited Warranty for SOL-ARK (Portable Solar LLC) Products. Sol-Ark provides a Five-year (5) limited Warranty ("Warranty") against defects in materials and workmanship for its Sol-Ark products ("Product"). The term of this warranty begins on the Product(s) initial purchase date, or the date of receipt of the Product(s) by the end user, whichever is later. This must be indicated on the invoice, bill of sale from your installer. This warranty applies to the original Sol-Ark Product purchaser and is transferable only if the Product remains installed in the original use location. Please call Sol-Ark to let us know if you are selling your Home and give us name and contact of the new owner.

The warranty does not apply to any Product or Product part that has been modified or damaged by the following:

- ❖ Installation or Removal (examples: wrong voltage batteries, connecting batteries backwards, damage due to water/rain to electronics, preventable damage to solar wires.)
- ❖ Alteration or Disassembly
- ❖ Normal Wear and Tear
- ❖ Accident or Abuse
- ❖ Unauthorized Firmware updates/software updates or alterations to the software code
- ❖ Corrosion
- ❖ Lightning: unless using EMP hardened system, then Portable Solar will repair product
- ❖ Repair or service provided by an unauthorized repair facility
- ❖ Operation or installation contrary to manufacturer product instructions
- ❖ Fire, Floods or Acts of Nature
- ❖ Shipping or Transportation
- ❖ Incidental or consequential damage caused by other components of the power system
- ❖ Any product whose serial number has been altered, defaced or removed
- ❖ Any other event not foreseeable by Portable Solar, LLC

**Contact Us: 1-972-575-8875**

**For Info/Purchasing:**

[sales@sol-ark.com](mailto:sales@sol-ark.com) | ext.1

**For Tech Support/Warranty Claim:**

[support@sol-ark.com](mailto:support@sol-ark.com) | ext.2

**For Administrative Help:**

ext.3

Sol-Ark (Portable Solar LLC) liability for any defective Product, or any Product part, shall be limited to the repair or replacement of the Product, at Portable Solar LLC discretion. Sol-Ark does not warrant or guarantee workmanship performed by any person or firm installing its Products. This warranty does not cover the costs of installation, removal, shipping (except as described below), or reinstallation of Products or parts of Products. LCD screen and fans are covered for 5 years from date of purchase.

THIS LIMITED WARRANTY IS THE EXCLUSIVE WARRANTY APPLICABLE TO SOL-ARK (PORTABLE SOLAR LLC) PRODUCTS. SOL-ARK EXPRESSLY DISCLAIMS ANY OTHER EXPRESS OR IMPLIED WARRANTIES OF ITS PRODUCTS. SOL-ARK ALSO EXPRESSLY LIMITS ITS LIABILITY IN THE EVENT OF A PRODUCT DEFECT TO REPAIR OR REPLACEMENT IN ACCORDANCE WITH THE TERMS OF THIS LIMITED WARRANTY AND EXCLUDES ALL LIABILITY FOR INCIDENTAL OR CONSEQUENTIAL DAMAGES, INCLUDING WITHOUT LIMITATION ANY LIABILITY FOR PRODUCTS NOT BEING AVAILABLE FOR USE OR LOST REVENUES OR PROFITS, EVEN IF IT IS MADE AWARE OF SUCH POTENTIAL DAMAGES.

**Return Policy - No returns will be accepted without prior authorization** and must include the Return Material Authorization (RMA) number. Please call and talk to one of our engineers to obtain this number at 972-575-8875.

**Return Material Authorization (RMA) A request for an RMA number requires all of the following information:** 1. Product model and serial number; 2. Proof-of-purchase in the form of a copy of the original Product purchase invoice or receipt confirming the Product model number and serial number; 3. Description of the problem; 4. Validation of problem by Technical Support, and 5. Shipping address for the repaired or replacement equipment. Upon receiving this information, the Sol-Ark representative can issue an RMA number.

Any product that is returned must be brand new, in excellent condition and packaged in the original manufacturer's carton with all corresponding hardware and documentation. Returns must be shipped with prepaid freight and insured via the carrier of your choice to arrive back at Portable Solar within 30 days of your initial delivery or pick-up. **Shipping charges will not be refunded.**

All returns are subject to a 35% restocking fee. **No returns will be accepted beyond 30 days of original delivery.** The value and cost of replacing any items missing (e.g. parts, manuals, etc.) will be deducted from the refund. If you have any questions regarding our return policy, please email us at [sales@sol-ark.com](mailto:sales@sol-ark.com) or call us at the number above during regular (M-F) business hours.

**Sol-Ark 5K Install Operational Verification Checklist Questionnaire must be filled out, signed, and dated to secure full warranty coverage.**