

Moving Flashing Forward

We set out to design a flashing that checked all the boxes: fully waterproof, fast and easy to install correctly, economical, and strong enough to handle every environmental condition. FlashVue does it all.

The optimized flashing design features a large viewport, for easy alignment with the pilot hole. And the GripCap and GripCap+ sit snugly in place, so the lag can be driven single-handedly.

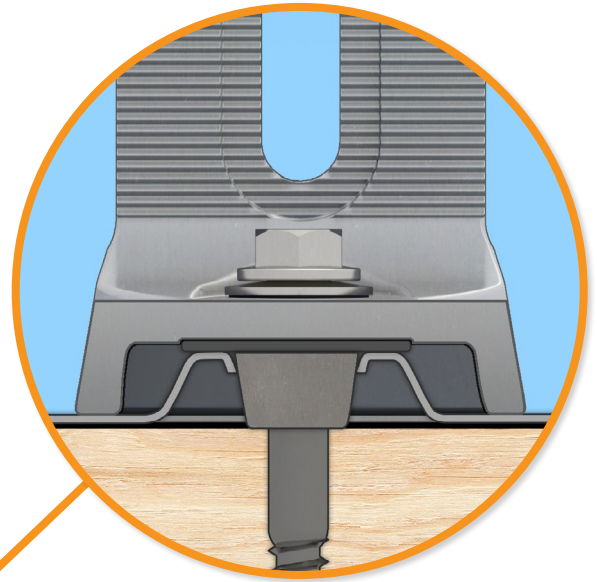

Three-Tier Water Seal, Reimagined

FlashVue's seal architecture utilizes three layers of protection. The viewport is elevated 0.30", and provides a "friction-fit" for the GripCap. The GripCap fully covers the viewport while a sealing washer adds another layer of protection. And an EPDM washer and lag bolt "seal the deal" in the stack.

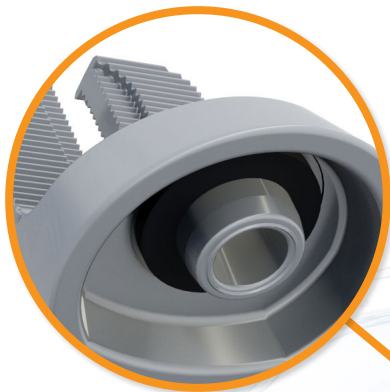

GripCap & GripCap+

The 360° capable GripCap (2.74" tall) and GripCap+ (3.74" tall) can be placed in any orientation, and provide a "friction-fit" for easy installs. Push snug into the viewport, without worrying it will roll away or rotate while driving the lag.

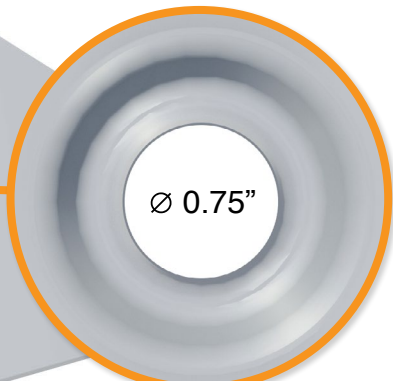

Ø 0.75"

Large Viewport in Flashing

The large viewport makes it easy to align the flashing with the pilot hole, and drive the lag centered into the rafter. The elevated rim not only provides a sturdy dock for the GripCap or GripCap+, but increases water-shedding capabilities.



Intertek

**Triple Certified to
Protect the Roof™**

UL 2703, 441 (27)
TAS 100(A)-95



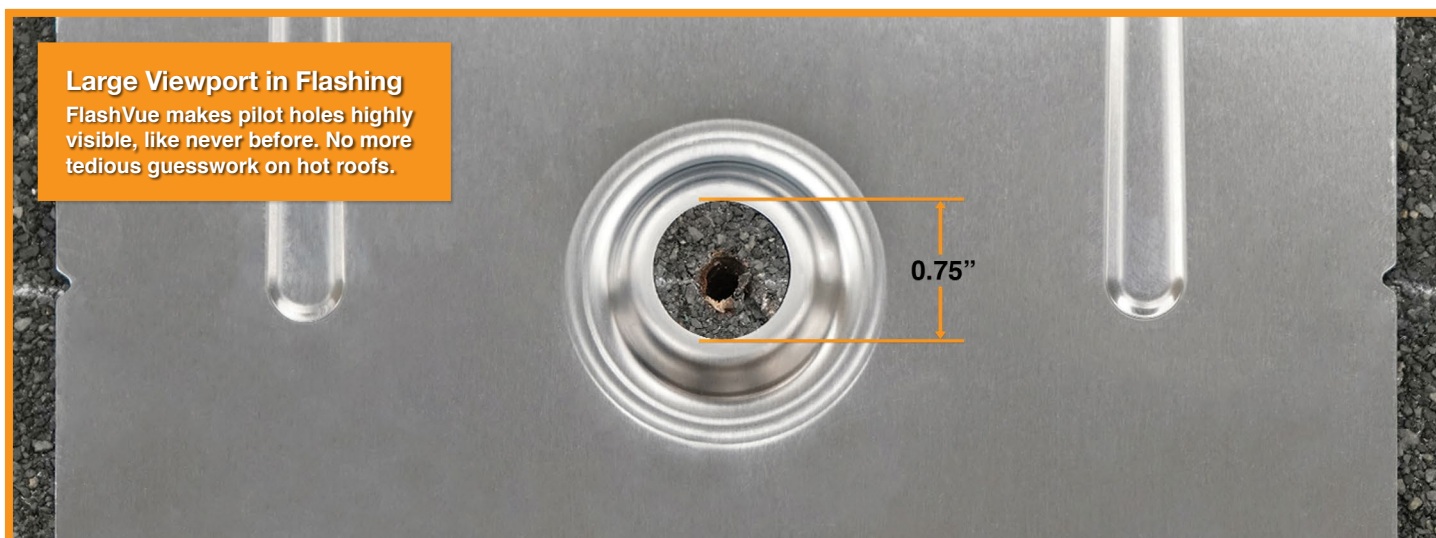

See Your Pilot Holes

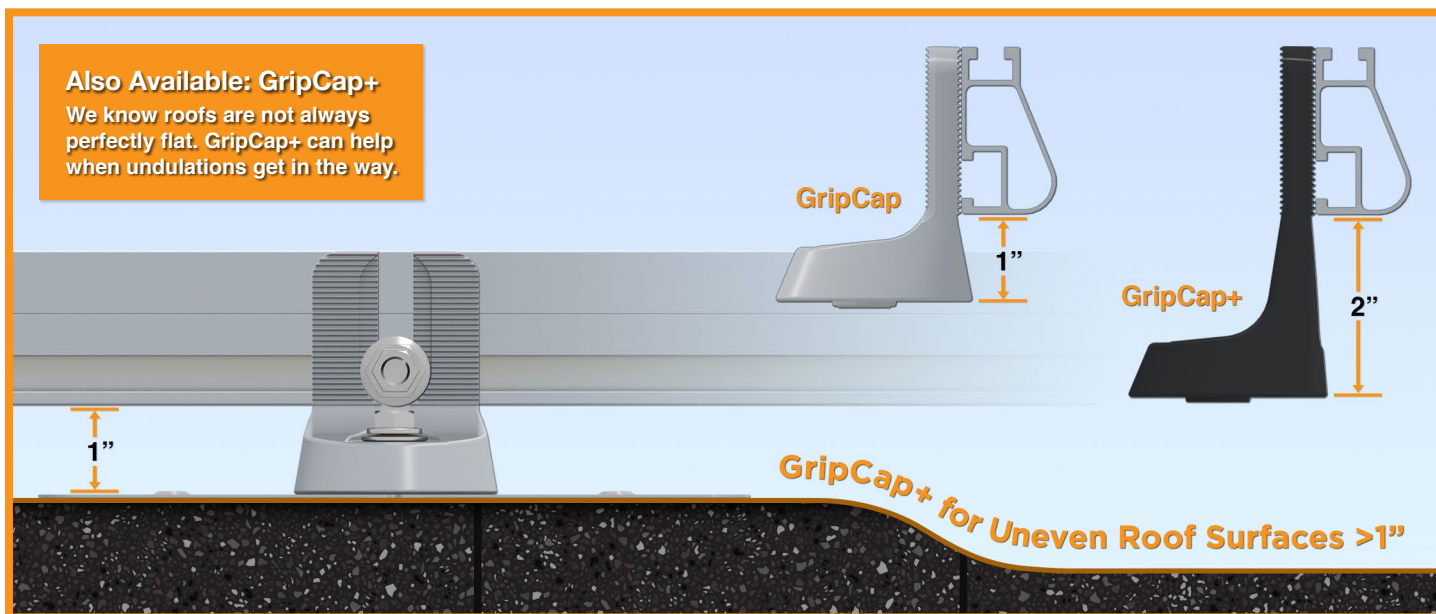

Solve Roof Undulations



Trusted Strength & Certification

- 
Attachment Loading
FlashVue has been tested and rated to support 1161 (lbs) of uplift and 353 (lbs) of lateral load.
- 
Structural Certification
Designed and certified for compliance with the International Building Code & ASCE/SEI-7.
- 
Water Seal Ratings
Passed both the UL 441 Section 27 "Rain Test" and TAS 100-95 "Wind Driven Rain Test" by Intertek.
- 
UL 2703 Listed System
Conforms to UL 2703 mechanical and bonding requirements. See Flush Mount Manual for more info.