

Raising the bar in innovative  
DC MLPE solar power systems

## RSD-S-PLC

- Meets NEC 2017 (690.12) requirements
- Executes rapid shutdown of system when Transmitter-PLC signal is absent
- Meets SunSpec requirements

### RSD-S-PLC Technical Data

Model	RSD-S-PLC
<b>Input Data (DC)</b>	
Input operating Voltage Range	8-80V
Maximum Cont. Input Current (Imax)	15A
Maximum Input Power	550W
<b>Output Data (DC)</b>	
Output operating Voltage Range	8-80V
Output Power Range	0-550W
Maximum System Voltage	1000V/1500V
<b>Mechanical Data</b>	
Operating Ambient Temperature Range	-40 °C to + 85 °C (-40 °F to +185 °F )
Dimensions (without cable&connectors)	5" x 1.2" x 0.6"(129 mm x 30 mm x 16 mm)
Cable length	Input 250mm/Output 1200mm or Customize
Module Connector	MC4 or MC4 Compatible
Enclosure Rating	Type 6P / IP68
Overtemperature protection	Yes
<b>Features &amp; Compliance</b>	
Communication	PLC
Safety Compliance	NEC 2017 (690.12); UL1741; CSA C22.2 No. 330-17; IEC/EN62109-1; 2PFG2305
EMC Compliance	FCC Part15; ICES-003; IEC/EN61000-6-1/-2/-3/-4

RSD-S-PLC meets SunSpec requirements, maintaining normal function by continually receiving a heart-beat signal from the APsmart Transmitter. The RSD executes rapid system shutdown when Transmitter signal is absent. Users can manually execute rapid shutdown using Transmitter breaker switch.

### RSD-S-PLC Wiring Diagram

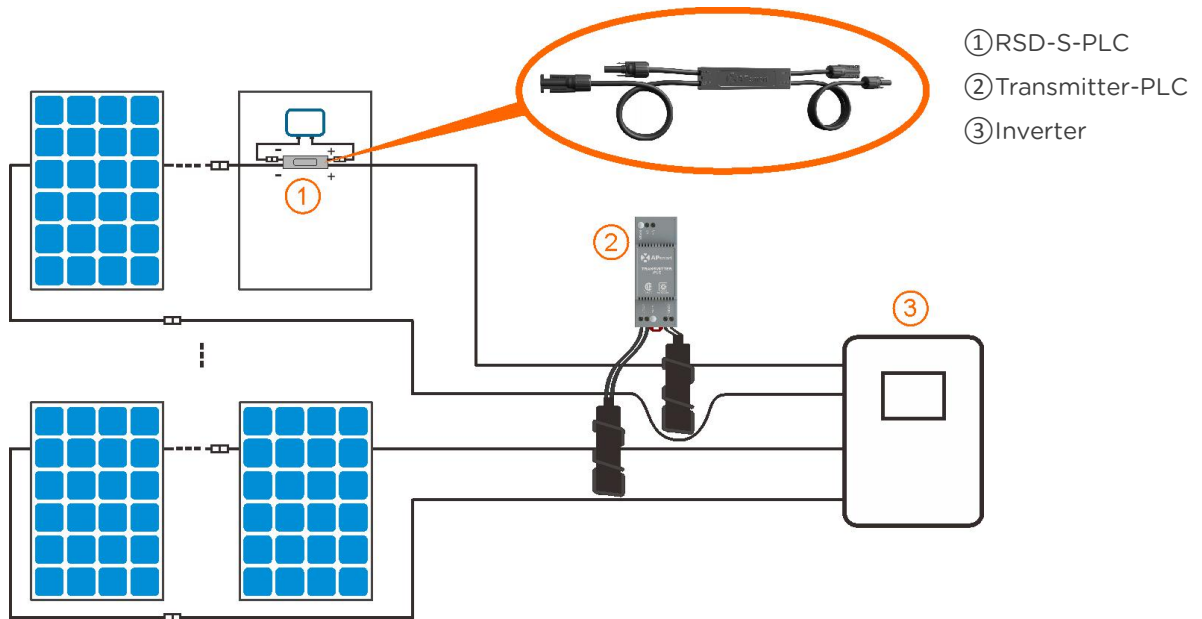

### Working Schematic Diagram

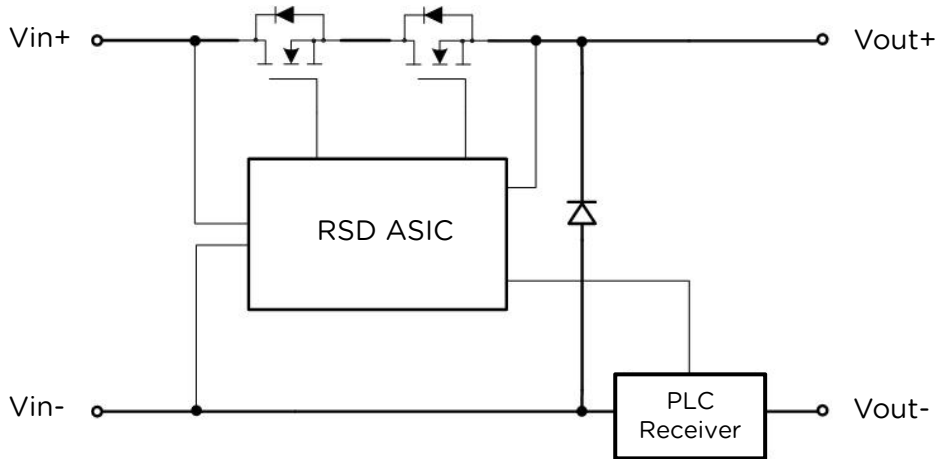

### ORDERING INFORMATION

405002	1500V UL/1000V TUV, 1.2m cable, MC4
405001	1000V UL/TUV, 1.2m cable, MC4 compatible
405003	1500V UL/TUV, 1.2m cable, MC4-Evo2